

CAT 4660

Parflex Thermoplastic & Fluoropolymer Products
Hose, Tubing, & Fittings 2018



ENGINEERING YOUR SUCCESS.

Extra care is taken in the preparation of this literature but Parker is not responsible for any inadvertent typographical errors or omissions. Information subject to change without notice. The information in this catalog is only accurate as of the date of publication. For a more current information base, please consult the Parflex® Division web site at www.parker.com/pfd.



FAILURE OR IMPROPER SELECTION OR IMPROPER USE OF THE PRODUCTS AND/OR SYSTEMS
DESCRIBED HEREIN OR RELATED ITEMS CAN CAUSE DEATH, PERSONAL INJURY AND PROPERTY DAMAGE.

This document and other information from Parker Hannifin Corporation, its subsidiaries and authorized distributors provide product and/or system options for further investigation by users having technical expertise. It is important that you analyze all aspects of your application and review the information concerning the product or system in the current product catalog. Due to the variety of operating conditions and applications for these products or systems, the user, through its own analysis and testing, is solely responsible for making the final selection of the products and systems and assuring that all performance, safety and warning requirements of the application are met.

The products described herein, including without limitation, product features, specifications, designs, availability and pricing, are subject to change by Parker Hannifin Corporation and its subsidiaries at any time without notice.

Offer of Sale

The items described in this document are hereby offered for sale by Parker Hannifin Corporation, its subsidiaries or its authorized distributors. This offer and its acceptance are governed by the provisions stated in the "Offer of Sale".

Welcome to The Parflex Division

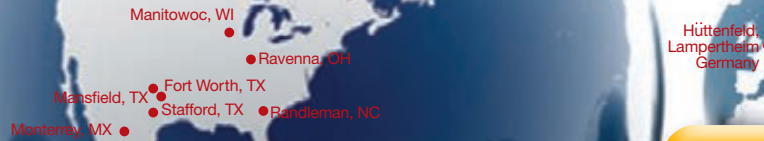

As part of the Parker Fluid Connectors Group, the Parflex Division is responsible for the design and manufacture of hoses and tubing to handle extreme applications. Products include thermoplastic and fluoropolymer hose and tubing, hose bundles, harnesses and accessories.

The Parflex Division includes the Ravenna, OH headquarters and manufacturing facilities in:

- Manitowoc, WI
- Fort Worth, TX
- Mansfield, TX
- Huttenfeld, Lampertheim, Germany - sister division, ***polyflex***
- Stafford, TX
- Randleman, NC
- Monterrey, Mexico

The Parflex Advantage

When compared to wire reinforced rubber hose or even metal tubing, thermoplastic hose offers significant added value. Thermoplastic provides excellent chemical compatibility, noise-level reduction and ultraviolet and corrosion resistance, while fiber reinforcement retains flexibility — even at low temperatures. In addition, Parflex has long-length capabilities resulting in less scrap being generated during assembly....fewer connections, results in fewer potential leak points.

For fluoropolymer hose, Parflex hoses are designed to handle high temperatures in chemical and corrosive environments for the industrial mobile, oil and gas, pharmaceutical and food and beverage markets.

Tap Into Our Resources in our state-of-the-art Polymer Innovation Center, driven by the single purpose of finding solutions to your most demanding fluid connector requirements. Abrasion, chemical compatibility, purity and permeation are just a few of the challenges our engineers work on everyday. The Polymer Innovation Center is your portal to an array of solution-driven abilities and assets, all conveniently situated within a single organization.

Our Charter

To be the global leader in engineered polymer-based products while providing system solutions for the conveyance and control of fluids.

Notes

Table of Contents

Intro	1-20		
Thermoplastic Hose Advantages	8	Fluoropolymer Hose Advantages	10
A Hose - Thermoplastic	A-1	Hose Fluoropolymer	A-58
Thermoplastic Hose Visual Index	A-4	Fluoropolymer Hose Visual Index	A-6
B Tubing - Thermoplastic	B-1	Tubing Fluoropolymer	B-44
Polyethylene	B-12	PTFE	B-50
Nylon	B-20	FEP	B-76
Polypropylene	B-28	PFA	B-90
Polyurethane	B-30		
Clear Vinyl	B-40		
C Coiled Air Hose & Fittings			
Fast-Stor® Air Hose	C-6	NoMar® Fast-Stor® Assemblies	C-8
Fast-Stor® Fittings	C-7	NoMar® Fast-Stor® Fittings	C-11
D Transportation (Fleet)			
Air Brake Tubing	D-4	Fifth Wheel Slider Coil	D-10
Diesel Fuel Tubing	D-5	Custom Harnesses, Bundles & Tubing	D-11
BRAKCOIL®	D-8	SCR Hose	D-12
Slider Coil™	D-9		
E Hose Fittings			
Fittings	E-1		
F Tooling			
Crimpers	F-5	Conversion Kits	F-16
Pumps	F-13	Cutting Tools	F-17
Sewer Hose Swagers & Accessories	F-13	Hose Accessories	F-18
Dies	F-15		
G General Technical			
Hose Selection, Installation & Mtn.	G-4	Die Selection & Swage Chart	G-36
Hose Assembly & Crimping	G-14	Technical Data	G-36
Safety Guide	G-56	Part Number Index	i
Offer of Sale	G-61	Keyword Index	iv

Catalog **How to Find Products**

1

Table of Contents

For quick, easy listing of topics covered by section, reference the Table of Contents on pg. 3.

2

Additional Catalogs (catalogs are linked)

- [Metal Hose, Flexible Braided Hose CAT 4690 MH](#)
- [Ultra High Pressure Thermoplastic Hose, Fittings and Accessories, CAT 4900](#)
- [Multitube Instrument and Heat Trace Products, CAT 4200-M-2](#)
- [Fluoropolymer Tubing CAT 4150-55](#)

Catalog Icons & Symbols

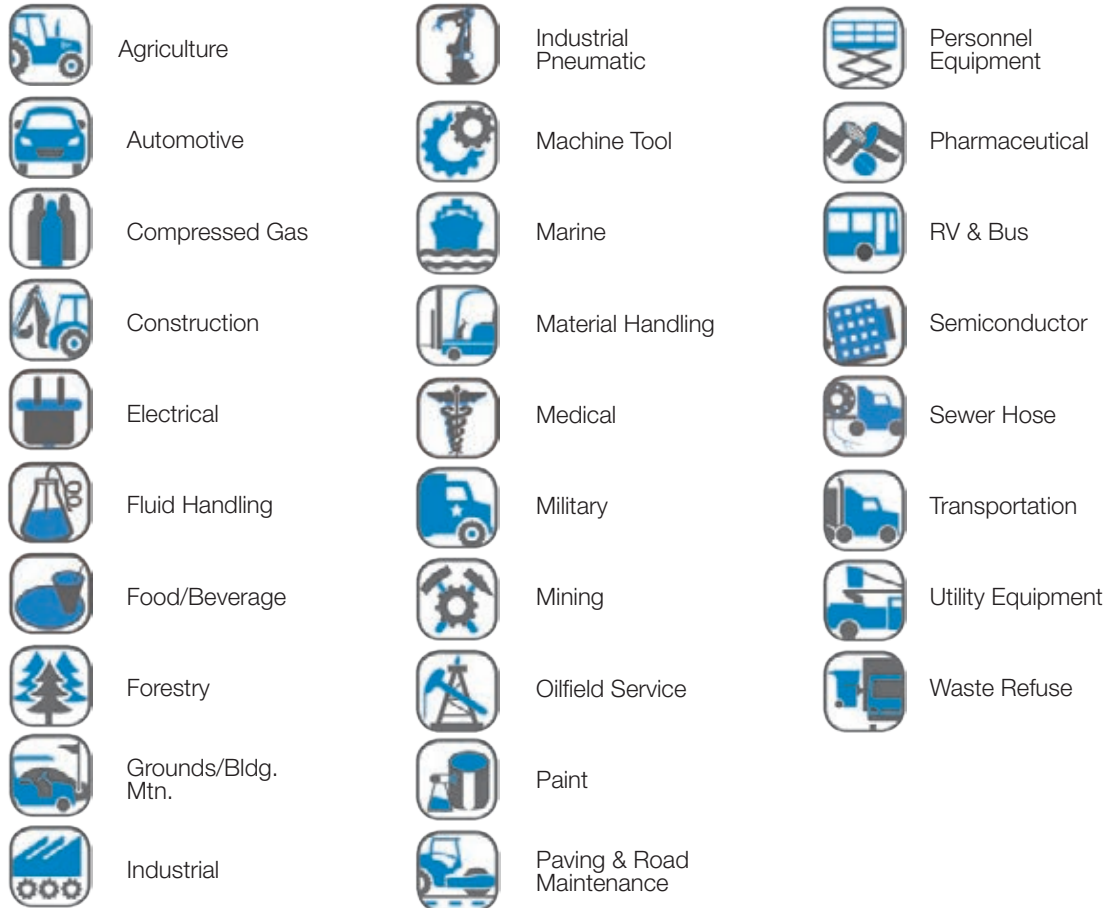

Symbol	Meaning
#	Part Number
	Hose Inner Diameter (I.D.)
	Hose Outer Diameter (O.D.)
	Working Pressure
	Minimum Bend Radius
	Crimp Die
	Crimp Fitting

Symbol	Meaning
	Minimum Burst Pressure
	Weight
	Vacuum Rating
	Thread Size
	Hex Size
	Diameter
	Field Attachable Fitting

Parflex offers more options. Without reducing performance.

Hose

Wire
or
Fiber
Braid



Heated
SCR Hose



High Temperature
Chemical Resistant
Hoses

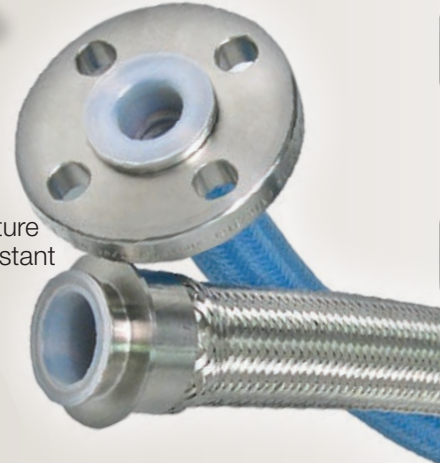

Compact I.D./O.D.
Hose



Tubing



Specialty
Designs



Retractable
Coils



Custom
Colors



Formed Tubing,
Harnesses and
Bundles



Fittings



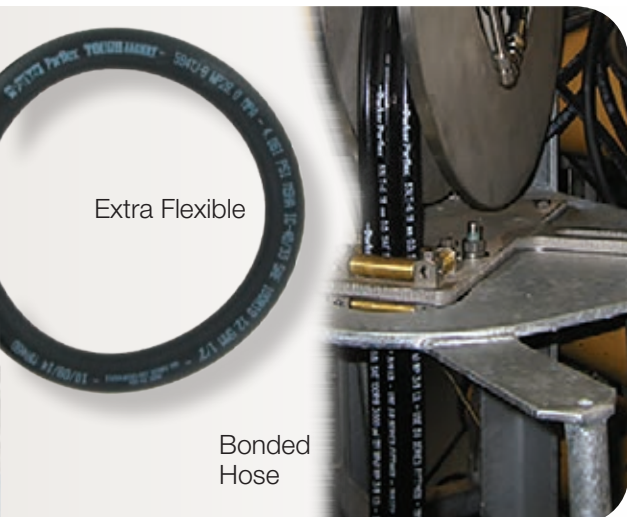

The thermoplastic hoses in this catalog are recognized for their cleanliness and their ease of use in confined spaces, their flexibility and light weight, their abrasion resistance and the fact that they deliver the same performance as competitive rubber hoses, but in a more compact design. In addition, they are available in much longer lengths than a rubber hose, reducing possible leak points and the accumulation of scrap from producing hose assemblies.

Parflex thermoplastic hoses are also available as a bonded assembly, preventing hose-to-hose abrasion and ease of routing for applications requiring more than one hose.

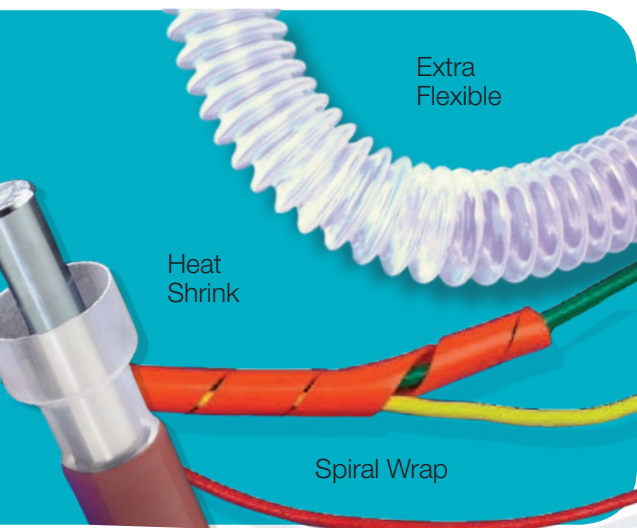

Parflex manufactures one of the largest selections available from one manufacturer. High and Low Temperature Tubing, Heat Shrink, Retractable Coils and many other designs are available, including convenient harness and bundle integration. Similar to bonding, harnesses and bundles ensures quick assembly, and eliminate waste and improve throughput.

Thermoplastic Tubing

- Polyethylene
- Nylon
- Polypropylene
- Polyurethane
- Clear Vinyl
- Airbrake Tubing
- Coiled Tubing

Fluoropolymer Tubing

- PTFE
- FEP
- PFA
- High Purity PFA
- Heat Shrink
- Convuluted
- Spiral Wrap

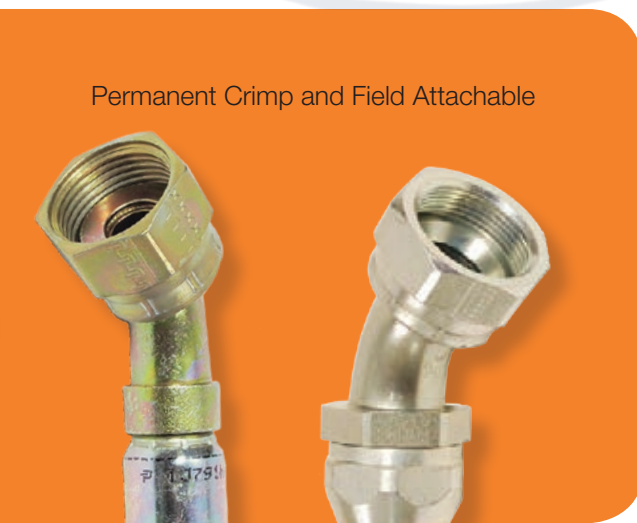

Parflex supplies a variety of fitting and hose equipment options including crimpers, cutters and more for creating hose assemblies.

For extreme temperatures (above 500°F) or chemical compatibility, Parflex provides Metal Hoses (refer to Catalog 4690) and for ultra-high pressures, **polyflex** Ultra High Pressure Hose and Fittings (view Catalog 4900).

Thinking “Extreme” Think Parflex

Thermoplastic Hose Advantages

Parker Parflex offers an extensive selection of high-quality thermoplastic and fluoropolymer hose and tubing, fittings and accessory solutions for “extreme” applications. We specialize in designing products to meet specific needs for increased profitability and efficiency.



In some product lines, continuous lengths up to 3,500 meters (11,484 feet) are available.

Long Lengths

Smaller I.D.

The Parflex manufacturing process does not require a mandrel for support of the core tube so hoses can be made to a smaller inner diameter such as 1.3 mm (.051 inch).

Thermoplastic

Elastomer (rubber)

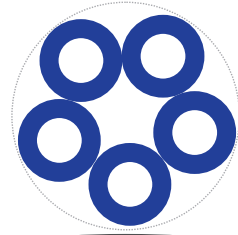
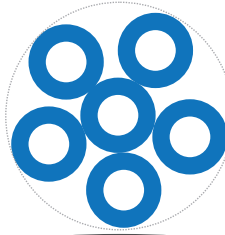

**~20%
IMPROVEMENT**

Size	Typical 100R17 Hose (rubber) inch / mm		D6R Hose inch / mm		Space Benefit
-4	0.52	13.2	0.46	11.7	11%
-6	0.67	17.0	0.61	15.5	9%
-8	0.81	20.6	0.76	19.3	7%
-10	0.98	24.8	0.96	24.4	2%
-12	1.15	29.2	1.15	29.2	0%
-16	1.47	37.3	1.44	36.5	2%

Compact designs allow for a tighter bend radius, allowing the hose to be used in smaller enveloped areas and facilitate quicker installs (up to 50%).

Compact O.D.

Light Weight

Parflex products are lighter in weight due to their fiber reinforcements. In fact, a Parflex hose can weigh more than 70% less than a comparable rubber hose assembly.

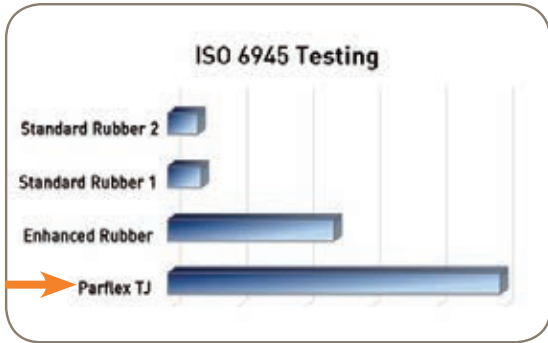
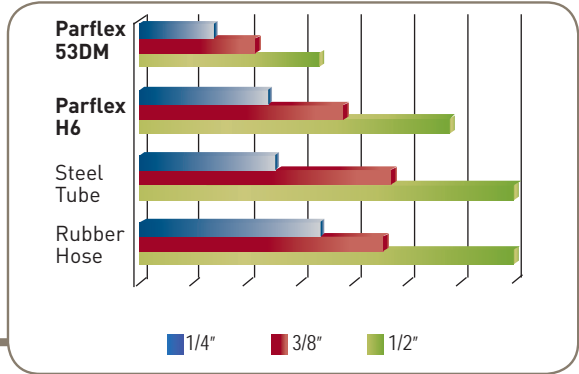

In our new Polymer Innovation Center, Parflex engineers blend resins and create patented designed hoses to reduce permeation and withstand hours of abrasion without damaging the hose.

Abrasion Resistance

Multi-Bonded

Parflex bonded assemblies help prevent hose-to-hose abrasion at high stress levels. Bonding 2 to 10 varying-sized hoses (maximum 6 inches (152 mm) wide) together, bonded assemblies keep hoses from rubbing against each other or tangling.



When will a **fluoropolymer product** add longevity to your application?

High temperatures and extreme chemicals are a couple of reasons.

See next page for more information or visit www.whyfluoropolymers.com

Thinking “Extreme Temperatures” Think Parflex PTFE

Fluoropolymer Hose Advantages

Parker Parflex manufactures PTFE hose for most markets that require high temperatures, chemical resistant hoses, or have applications where lubricity plays a critical factor in the success of the operation. Increased lubricity facilitates flow and makes for easy cleaning.

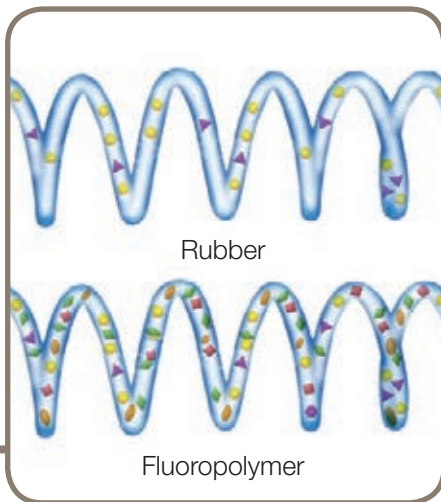

Chemical Compatibility

The chemical compatibility of fluoropolymers is far greater than conventional thermoplastics or rubber products.

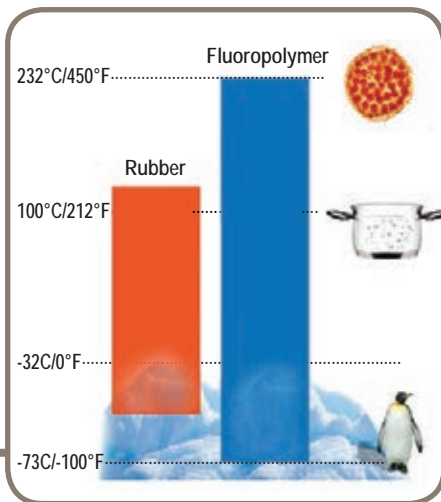

High/Low Temperatures

PTFE products boast an operating temperature range of -100°F (73°C) to 500°F (260°C). For FEP and PFA, view specific materials for actual operating temperatures.

In cold or heat, Fluoropolymers provide improved performance to flexing, vibration and impulse. Customers who make the switch not only reduce unscheduled maintenance repairs, but often, warranty repairs as well.



Shelf Life

Under optimal storage conditions, fluoropolymer and thermoplastic hose and tubing products should have unlimited storage life prior to initial usage.*

***Per SAE J1273 - Rubber Hose, in bulk form passing visual inspection and proof test, shall be acceptable for use up to and including 40 quarters (10 years) from the date of manufacture if stored properly. Shelf life of thermoplastic and polytetrafluoroethylene (PTFE) hose is considered to be unlimited if stored properly. Hose assemblies that pass inspection and proof test shall not be stored for longer than 2 years.**

When will a
thermoplastic product
be more advantageous?

One reason is when you need a multi-line bonded hose.

See page 8 for more information or visit www.whithermoplastics.com

Selecting the Correct **Hose**

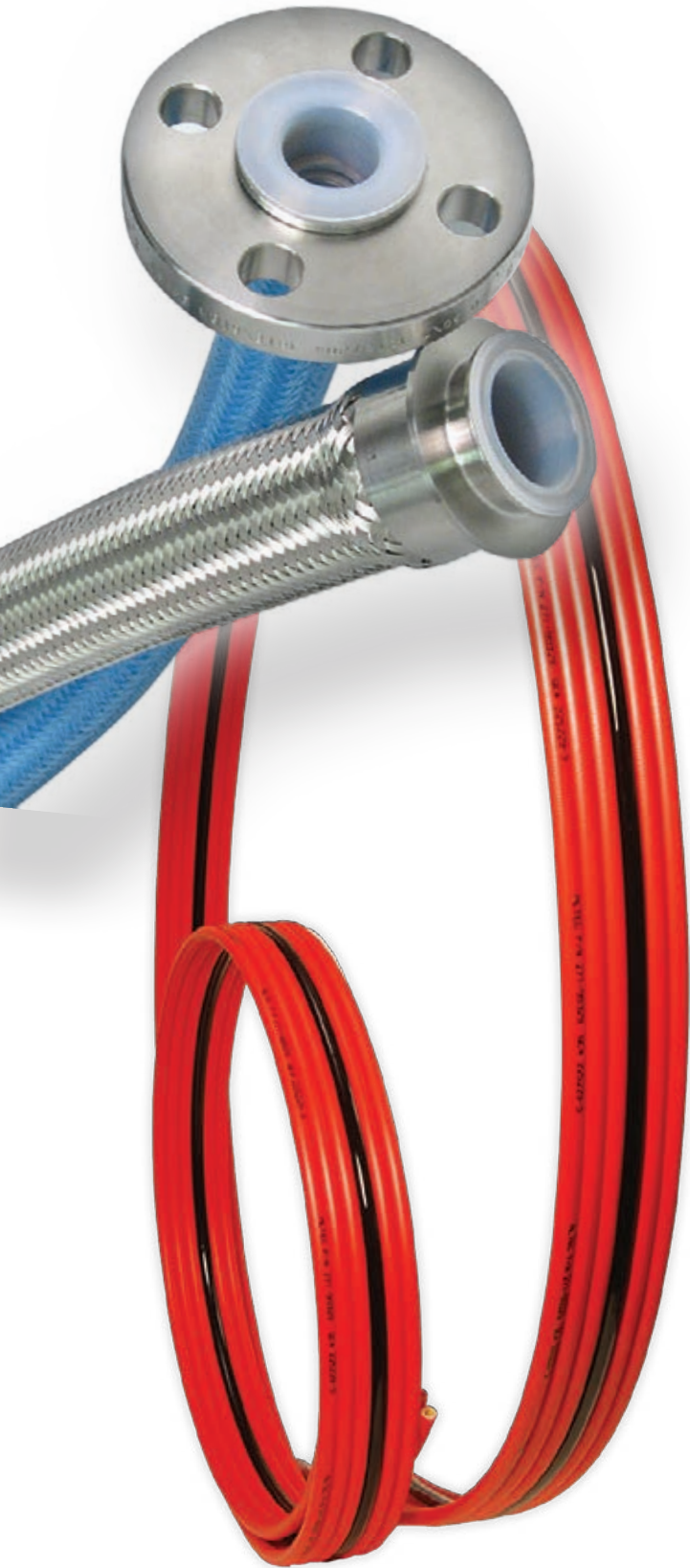

Before selecting hoses from Catalog 4660, it will be easier if you familiarize yourself with the basics of thermoplastic and fluoropolymer hoses by reviewing the symbols on pg. 5 and "Hose Assembly Part Numbers" on pg. A-18. Also, the Parflex Hose Selection Charts (located in Section A) will help pinpoint the hose you require. It will help you identify individual hoses by:

- Brief general description
- Specific size with corresponding working pressure
- Industry specification (ie. SAE)
- Core tube material
- Reinforcement/type of construction
- Cover material
- Specific page number where further detailed product information can be found

For fittings, refer to the visual indexes in Section E



Selecting the Correct **Hose**

“STAMPED”

Size

The appropriate inside and outside diameters

Temperature

The ambient and minimum/maximum temperature of the material being conveyed

Application

External conditions including abrasion, climate, heat, flexing, routing and degrees of bending

Media

The composition of the substance being conveyed and chemical compatibility with the hose inner core and, if applicable, the outer cover

Pressure

The maximum vacuum or pressure of the system, including pressure spikes

Ends

The appropriate end connection, material and attachment method for the application

Delivery

Testing, quality, packaging, and delivery requirements

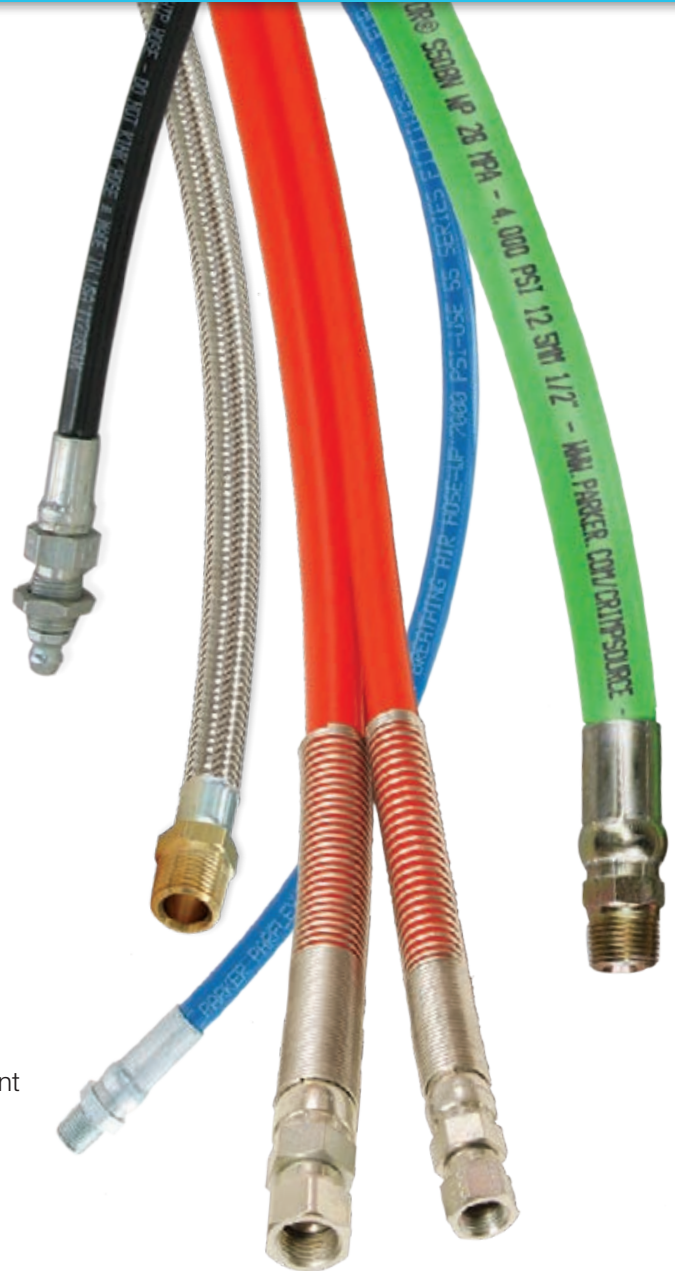

Overview Parflex Part Numbers

To make ordering of Parflex products easier, a part number description section has been added for hose, tubing and fitting products. For additional nomenclature information, refer to the following pages:

- Hose - Section Apgs. A-18 : A-21
- Tubing - Section BThermoplastic - See specific product page; Fluoropolymer pg. B-48
- Fittings - Section Epgs. E-3

Hose Part Numbers

Parflex offers thermoplastic and fluoropolymer hoses in standard and custom designs such as bonded, formed, extra flexible, specialty braid and jackets and more...

<p>Thermoplastic & Fluoropolymer</p> <p>Example: 520N – 8</p> <p>520N – 8 – Hose type (General Hydraulic Hose)</p> <p>520N – 8 – Hose inside diameter dash size (1/2")</p>	<p>Parflex PAGE Fluoropolymer</p> <p>Example: 16-SCW</p> <p>16-SCW – Hose inside diameter dash size (1")</p> <p>16-SCW – Hose type (Seamless Convolved with Stainless Steel Braid)</p>
---	---

Hose Assembly Part Numbers

Example: F540N0639080808C-30"

This assembly example reflects a 1/2" I.D., 540N hose with a female JIC 37° swivel straight fitting on the first end and a female JIC 37° - swivel - 90° elbow fitting on the other. The fittings are stainless steel and crimped (permanently attached) onto the hose. The overall length is 30".



<p>1. Prefix</p> <p>F540N0639080808C-30"</p> <p>F = Crimp R = Field Attachable A = 54 Series Factory</p>	<p>3. Fitting 1st End</p> <p>F540N0639080808C-30"</p> <p>SAE 1/2" female JIC 37° swivel straight fitting</p>	<p>5. Size 1st End</p> <p>F540N0639080808C-30"</p> <p>1/2"</p>	<p>7. Hose End Dash Size</p> <p>F540N0639080808C-30"</p> <p>1/2"</p>
<p>2. Hose type</p> <p>F540N0639080808C-30"</p> <p>General Hydraulic Hose</p>	<p>4. Fitting 2nd End</p> <p>F540N0639080808C-30"</p> <p>SAE 1/2" 90° female JIC 37° swivel elbow fitting</p>	<p>6. Size 2nd End</p> <p>F540N0639080808C-30"</p> <p>1/2"</p>	<p>8. Fitting Material</p> <p>F540N0639080808C-30"</p> <p>- Blank = Steel (unless noted) - C = Stainless</p>
<p>9. Length</p> <p>F540N0639080808C-30"</p> <p>30" overall length</p>			

A complete nomenclature guide for Parflex PAGE hoses is located in Section A on pg. A-21.

Overview Parflex Part Numbers

Hose Fittings Part Numbers

Parflex fittings are available in inch and metric designs.

Example: 10356-8-6

This example describes a permanent crimp 1/2" Male JIC 37° Rigid hose end with a 3/8" hose end. This fitting is constructed of steel since the designated material is blank.

10356-8-6 – Fitting Type (1 = Permanent/Crimp)

10356-8-6 – End Configuration Code
(Male JIC 37° Rigid)

10356-8-6 – Fitting Series (56 Series)

10356-8-6 – End Connection Size (1/2")

10356-8-6 – Hose Size (3/8")

Fitting Material

- Blank = Steel (unless otherwise noted)
- C = Stainless Steel
- S = Steel – Used only with PTFE Fittings

Tubing Part Numbers

The Parflex Tubing Section includes Thermoplastic and Fluoropolymer resins. In addition to smooth bore tubing, fluoropolymer products include convoluted tubing and heat shrinkable tubing. This tubing is supplied in natural and colors are available upon request. For a detailed fluoropolymer nomenclature guide, review Section B, pg. B-48.

Thermoplastic

Example: U-21-BLU-0250

U-21-BLU-0250 – Polyurethane

U-21-BLU-0250 – Tube O.D.

in sixteenths of an inch (1/8")

U-21-BLU-0250 – Tube I.D.

in sixteenths of an inch (1/16")

U-21-BLU-0250 – Color (Blue)

U-21-BLU-0250 – Package Qty. (250')

Available colors

- | | |
|------------------|------------------------------|
| ● BLK = Black | ● ORG = Orange |
| ● BLU = Blue | ● RED = Red |
| ● GRY = Gray | ● YEL = Yellow |
| ● GRN = Green | |
| ● None = Natural | (colors may vary by product) |

Fluoropolymer

Example: 101-0250062-NT-0100

101-0250062-NT-0100 – Fractional

101-0250062-NT-0100 – PTFE

101-0250062-NT-0100 – Tube O.D.

inch displayed in decimals (1/4")

101-0250062-NT-0100 – Wall Thickness

inch displayed in decimals (.062")

101-0250062-NT-0100 – Color (Natural)

101-0250062-NT-0100 – Bulk Tubing

101-0250062-NT-0100 – Package Qty. (100')

Available colors

- | | |
|---------------|--------------|
| ● N = Natural | ● 5 = Green |
| ● 0 = Black | ● 3 = Orange |
| ● 6 = Blue | ● 2 = Red |
| ● 1 = Brown | ● 4 = Yellow |
| ● 8 = Gray | ● 9 = White |

Overview Parflex Tubing Applications

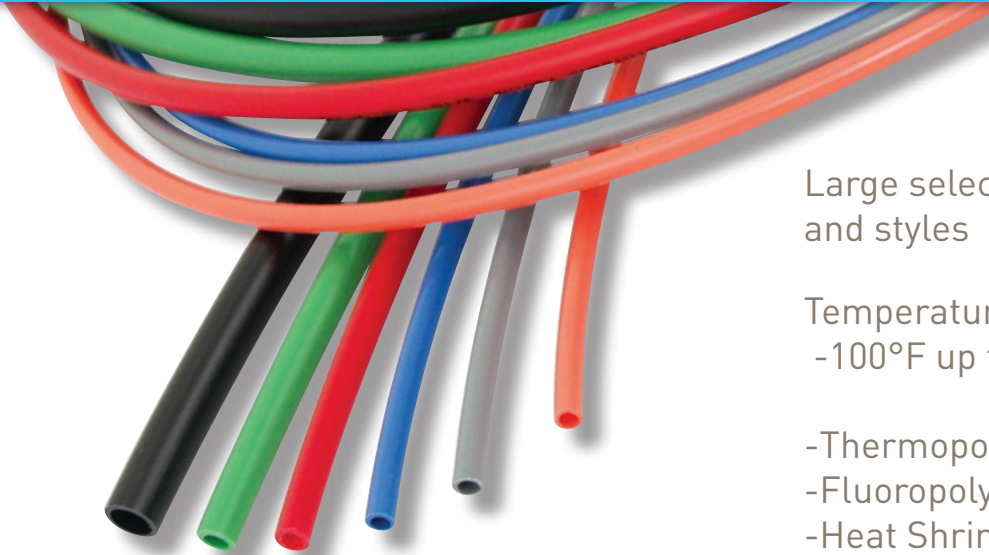

Large selection of tubing material and styles

Temperatures range from -100°F up to 500°F

- Thermopolymer
- Fluoropolymer
- Heat Shrinkable
- Convolutd
- Corrugated
- Air Brake



EZ Pack 100 foot boxes

Contact Customer Service for Retail Packaging Options

Benefits of Thermoplastic Tubing Materials and Applications*

Nylon	Strength Chemical Compatibility	<p style="text-align: center;">Typical Applications</p> <p>Instrumentation Food & Beverage</p> <p>Potable Water Chemical Transfer</p> <p>Pneumatics Robotics</p> <p>Machine Tools Lubrication</p> <p>Pest Control Lines Semiconductor</p> <p>Marine Applications</p> <p>Weld Spatter/Spark Environments</p>
Polyethylene	Food Contact Potable Water Price	
Polyurethane	Flexibility	
Polypropylene	Food Contact Chlorinated Water	
Vinyl	Price Flexibility Food Contact Clarity	

*Certain materials perform better in particular applications. Contact Customer Service for details.

Overview Parflex Tubing Applications



Benefits of Fluoropolymer Tubing Materials and Applications*

All	Self extinguishing Chemical resistant FDA & USP Class VI compliant
PTFE	Operates up to 500°F Lowest coefficient of friction Best flex life
FEP	Operates up to 400°F Best clarity
PFA	Operates up to 500°F Best purity High purity resins available

*Certain materials perform better in particular applications. Contact Customer Service for details.

Typical Applications

Pharmaceutical	Solar Panels
Pulp & Paper	Food Processing
Chemical Delivery	Chromatography
Paint Equipment	Instrumentation
Heat Exchanger	Ink Rollers
Medical Devices	
Environmental Sampling	

Where will you find Parflex?



Where will you find Parflex?



Typical Applications - Parflex

Mobile Hydraulics

Markets

- Material Handling Equipment
- Marine
- Agricultural Equipment
- Utility Equipment
- Sewer Cleaning Equipment
- Aerial Lift
- Construction Equipment
- Rough Terrain Equipment
- Refuse Haulers
- Mining



Parflex Mobile Hydraulic products meet the needs of four primary market segments: aerial lift, agriculture, construction and material handling.

Applications

- Aerial Lift Hydraulic Tools
- Cold Storage
- Compressor Discharge
- Conveyor Equipment
- Diagnostics/Gaging
- General Hydraulics
 - Off-Road Construction
 - Earth Moving Equipment
 - Lift Trucks
 - Material Handling
 - Construction Equipment
 - Refuse Haulers
 - Agricultural Equipment
- Implement Hydraulic Power
- Lubrication Systems
- Mower Attachments
- Over-the-Sheave
- Pilot Control Lines
- Power Steering
- PTO's
- Turbo Drain Lines

Fluid Handling

Markets

- Industrial Equipment
- Utilities (CNG)
- Semiconductor
- Chemical
- Commercial Refrigeration
- Water Treatment
- Power Cleaning
- Power Generation
- Car Care
- Pharmaceutical
- Bio-Pharm
- Pulp & Paper
- Oil & Gas



Parflex Fluid Handling products are categorized by their thermoplastic and fluoropolymer (PTFE) makeup. Parflex offers standard and custom designed solutions such as bonded, harnessed and formed products.

Applications

- Agricultural Spraying
- Alternative Fuels
- Breathing Air Systems
- Car Care
- Carpet (Power) Cleaning
- Chemical & Gas Transfer
- Chemical Dispensing
- Coolant Lines
- Dispensing
- Food and Beverage
- Lubrication Systems
 - Machine tool
 - Heavy equipment
- Oil & Gas Transfer (Petrochemical)
- Pharmaceutical
- Potable Water Delivery
- Semiconductor (Pure air or gas transfer)
- Sewer Cleaning
- Steam Transfer

Typical Applications - Parflex

Parflex offers a diverse product line that includes lightweight, non-marring, flexible hose and thermoplastic or fluoropolymer tubing.

Applications

- Air Tools
- Automotive Maintenance
- Carpentry Framing
- End-of-Arm Tooling
- General Robotics
- Metal Working
- Pneumatic Systems
- Robotic Welding
- Testing Equipment

Industrial Pneumatics



Markets

- Robotics
- Packaging Machinery
- Machine Tool
- Carpentry
- Automotive Maintenance
- Medical Equipment
- Laboratory Equipment
- Furniture Manufacturing
- Paper Manufacturing

Our products thrive in harsh environments

Parflex develops thermoplastic hose products from fiber, wire and aramid fiber reinforced products to steel and stainless steel fittings to equipment & accessories for today's fastest growing markets.

Applications

- Automotive Maintenance
- General Hydraulic Lines
- Hydraulic or Vacuum Connections
- Injection Molding
- Lubrication Systems
- Pumps
- Machine Tool
 - Metal Forming
 - Bending Machines
 - Vertical Machining
 - Metal Cutting
- Molding and Transfer Lines for Plastics
- Press Brakes

Industrial Hydraulics



Markets

- Machine Tools
- Hydraulic Tools
- Mining
- Patient Handling
- Car Care
- Automotive
- Rescue Tools
- Lubrication Systems
- Recreational Vehicles

Typical Applications - Parflex

Transportation

Markets

- Class 8 Heavy Truck
- Standard Box Truck
- Diesel Truck
- Bus
- Refrigeration Truck
- Refuse Truck
- Fire Truck
- Trailers
- Street Sweepers
- Military Vehicles
- RV's



An extensive line of transportation products includes a selection of air brake tubing for standard distribution and large OEMs, air brake harnesses, coils, fuel tubing and 100% pressure-tested fleet tubing for use with diesel fuel.

Applications

- Air Lines
- Coiled Air Brake
- Compressed Natural Gas
- Compressor Discharge
- Exhaust and AC Lines
- Fuel Lines
- Fuel Transfer
- Hydraulics
- Hydrostatic Pumps
- Lubrication Systems
- Power Steering
- Pump Outlets
- SCR System DEF Conveying
- Service/Emergency Connections



Life Science

Markets

- Medical Device
- Medical Equipment
- Diagnostic Equipment
- Pharmaceutical
- Veterinary



Parflex has extended the selection of medical tubing capabilities and specializes in the extrusion of precision tolerances for custom tubing and custom profiles of PTFE, ePTFE, FEP, PFA, and ETFE.

Applications

- Air and Gas Transport
- Blood Analyzer
- Catheter Liners
- Catheter Reflow
- Drug Delivery
- Endoscopic Instruments
- Introducers
- Lab Instruments
- Laparoscopic Instruments
- Sheathing
- Surgical Robotics
- Tracheotomy Tubes

Typical Applications - Parflex

Parflex products for the Food and Beverage market are comprised of FDA and NSF compliant hose and tubing. Specialty hoses and tubing products are also available for increased vacuum or purity.

Applications

- Transport of Edible Oils, Syrup, Milk and other Food Products
- Chillers
- Commercial Freezers
- Dispensing Equipment
- In-plant Transfer for Processing
- Label/Adhesive Machinery
- Packaging Equipment
- Tank Transfer of Raw Products

Food & Beverage



Markets

- Food
- Beverage



Certified to
NSF/ANSI 61

COMPONENT

-C-HOT-

-NSF-51-

Parflex Multitube® offers a variety of thermal control tubing products, such as steam and electric trace tubing, as well as analyzer and probe support bundles. Refer to Catalog 4200-M-2, Instrument and Heat Trace Tubing Products for product details.

Applications

- Analyzers
- Condensate Return Lines
- Cooling Water Lines
- Environmental Monitoring
- Instrumentation Lines
- Liquid Nitrogen Transfer
- Maintenance Bundles
- Probe Support Umbilicals
- Process Lines
- Refrigeration
- Sample Lines
- Stack Gas Sampling
- Steam Purge / Steam Supply Lines

Energy



Markets

- Chemical Processing
- Environmental
- Power Generation
- Process Control
- Refineries
- Utilities



Thermoplastic
Fluoropolymer



Table of Contents

Introduction

B Tubing	Visual Index.....	A-4
	Understanding Parflex Hose.....	A-7
	How to Read the Hose Section	A-8
	Hose Constructions	A-9
	Thermoplastic Hose Selection - Construction/Specifications, psi	A-10
Thermoplastic Hose Selection - Construction/Specifications, MPa.....	A-14	
Fluoropolymer Hose Selection - Construction/Specifications, psi.....	A-12	
Fluoropolymer Hose Selection - Construction/Specifications, MPa	A-16	

C Coiled Air Hose & Fittings	Nomenclature - Parflex Thermoplastic Hose Assembly.....	A-18
	Nomenclature - Parflex PTFE Hose Assembly.....	A-20
	Nomenclature - "True-Bore" & Convoluted Hose Assembly.....	A-21

Parflex Thermoplastic Hose

D Transportation	510A Refrigerant.....	A-32
	510C General Hydraulic.....	A-33
	518C Non-Conductive Hydraulic	A-34
	518D Non-Conductive Hydraulic	A-35
	515H Compact/Light Weight	A-36

E Fittings	520N/528N General Hydraulic.....	A-37
	527BA Breathing Air Refill, 7000 psi	A-38
	528N General Hydraulic, Non-Conductive	A-37
	53DM/538DM DuraMax™ Low Temperature/Non-Conductive	A-39
	540N General Hydraulic.....	A-40

F Tooling, Equipment & Accessories	540P Specialty Water	A-41
	55LT Low Temperature	A-42
	560TJ TOUGHJACKET™ SAE 100R1AT Hydraulic.....	A-28
	563TJ TOUGHJACKET™ SAE 100R17 Hydraulic, 3000 psi.....	A-29
	56DH Diagnostic/Non-Conductive.....	A-43

G General Technical	575X/575XN Fast Response, 5000 psi.....	A-44
	580N/H580N High Pressure	A-45
	588N High Pressure, Non-Conductive	A-45
	590TJ TOUGHJACKET™ Hydraulic Hose	A-30
	594TJ TOUGHJACKET™ SAE 100R19 Hydraulic, 4000 psi	A-31

G General Technical	5CNG Electrically Conductive Compressed Natural Gas.....	A-49
	83FR DuraGard™ General Purpose Polyurethane	A-46
	1035HT High Temperature Power Cleaning	A-47
	B9 General Purpose Transfer Hose.....	A-48
	CNGRP – Regulated Pressure Natural Gas, Electrically Conductive	A-50

Parflex Thermoplastic Hose (cont.)

D6R/D6RX Hybrid® Hose, Constant Pressure, 3000 psi	A-22
H6 Hydraulic Hose, Constant Pressure, 3000 psi.....	A-25
HFSR Hybrid®, Rubber Hose	A-23
HFS2R Hybrid®, Rubber Hose	A-24
HLB Lubrication Line.....	A-51
HTB Eliminator® Hybrid®, Compact.....	A-27
MSH Marine Steering.....	A-52
MSXL High Pressure Marine Steering.....	A-53
PTH Marine Power Tilt.....	A-54
R6 – Abrasion King® Hybrid® Hose, 3000 psi	A-26
S5N Predator® Water Jetting, 4000 psi	A-55
S6 Predator® Water Jetting, 2500 psi	A-56
S9 Predator® Water Jetting, 3000 psi	A-57

Parflex Specialty Hose Highlights

Metal Hose 9A, 9M, 9P	A-70
Multitube® BOP Bundles, Electro-Hydraulic Umbilicals and Hotlines.....	A-71
polyflex Ultra-High Pressure Hose	A-72

Parflex Fluoropolymer Hose

919/919B PTFE Hose, Natural & Static Dissipative Core Tube	A-58
919J PTFE Hose, Silicone Cover	A-59
919U PTFE Hose, High Abrasion Resistance	A-60
929/929B Heavy Wall PTFE Hose, Natural & Static Dissipative Core Tube.....	A-61
929BJ PTFE Hose, Static Dissipative Core Tube, Silicone Cover	A-62
939/939B Convoluted PTFE Hose, Natural & Static Dissipative Core Tube	A-63
944B High Pressure PTFE Hose, Static Dissipative Core Tube, up to 4500 psi	A-64
955B High Pressure PTFE Hose, Static Dissipative Core Tube, 5500 psi	A-65

PAGE Fluoropolymer Hose

STW/STB PTFE Hose, “True-Bore”, Natural & Static Dissipative Core Tube.....	A-66
SCW/SCB Convoluted PTFE Hose, SS Braid, Natural & Static Dissipative Core Tube.....	A-67
SCWW/SCBV Heavy Wall Convoluted PTFE Hose, SS Braid, Natural & Static Dissipative Core Tube.....	A-68
NCW/NCB Nomex® Covered PTFE Hose, Natural & Static Dissipative Core Tube.....	A-69

Nomex® is a registered trademark of
E. I. du Pont de Nemours and Company.

Parflex Hose Visual Index

B Tubing	Parflex Thermoplastic		510A Refrigerant  A-32	510C General Hydraulic  A-33	518C Non-Conductive Hydraulic  A-34
	518D Non-Conductive Hydraulic  A-35	515H Compact/Lightweight  A-36	520N General Hydraulic  A-37	528N Non-Conductive Hydraulic  A-37	
C Coiled Air Hose & Fittings	527BA Breathing Air Refill 7000 psi  A-38	53DM DuraMax™ Low Temperature, 3000 psi  A-39	538DM DuraMax™ Low Temperature, Non-Conductive 3000 psi  A-39	540N General Hydraulic  A-40	
	540P Specialty Water  A-41	55LT Low Temperature  A-42	560TJ TOUGH JACKET™ General Hydraulic  A-28	563TJ TOUGH JACKET™ Constant Pressure, 3000 psi  A-29	
D Transportation	56DH Diagnostic Hose  A-43	575X 575XN Fast Response 5000 psi  A-44	580N H580N High Pressure  A-45	588N Non-Conductive High Pressure  A-45	
	590TJ TOUGH JACKET™ General Hydraulic  A-30	594TJ TOUGH JACKET™ Constant Pressure, 4000 psi  A-31	83FR General Purpose  A-46	1035HT High Temp. Power Cleaning  A-47	
E Fittings	B9 General Purpose  A-48	5CNG Compressed Natural Gas, Electrically Conductive  A-49	CNGRP Regulated Pressure CNG, Electrically Conductive  A-50	D6R D6RX Constant Pressure, 3000 psi  A-22	
	H6 Hydraulic Hose, Constant Pressure 3,000 psi  A-25	HFSR Hybrid® Hose with Rubber Cover  A-23	HFS2R Hybrid® Hose with Rubber Cover  A-24 HYBRID®	HLB Lubrication Line  A-51 HYBRID®	
F Tooling, Equipment & Accessories	HTB Eliminator® Compact  A-27 HYBRID®	MSH Marine Steering  A-52	MSXL Marine Steering, High Pressure  A-53	PTH Marine Power Tilt  A-54	
	General Technical				

Parflex Hose Visual Index (cont.)

Parflex Thermoplastic (cont.)	R6 Constant Pressure 3000 psi	S5N Predator® Water Jetting 4000 psi	S6 Predator® Water Jetting 2500 psi
	 A-26	 A-55	 A-56
S9 Predator® Water Jetting 3000 psi	 A-57		

Parflex Specialty Hose Highlights

Metal Hose
Standard, Ultra Flexible, and Ultra High Pressure
 A-70

Multitube®
BOP Bundles, Electro-Hydraulic Umbilicals, and Hotlines
 A-71

polyflex
Ultra-High Pressure Thermoplastic Hose, Oil & Gas, Water Blast and Hydraulic Tool Hose
 A-72

Hose
A

Tubing
B

Coiled Air Hose & Fittings
C











Transportation
D







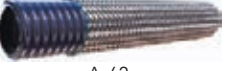

Fittings
E

Tooling, Equipment & Accessories
F

General Technical
G

Parflex Hose Visual Index (cont.)

Parflex PTFE	919 PTFE Hose	919B PTFE Hose with Static-Dissipative Tube	919J Silicone Covered PTFE Hose
	 A-58	 A-58	 A-59
919U High Abrasion Resistance PTFE Hose	929 Heavy Wall PTFE Hose	929B Heavy Wall PTFE Hose with Static-Dissipative Tube	929BJ Silicone Covered PTFE Hose with Static-Dissipative Tube
 A-60	 A-61	 A-61	 A-62
939 Convuluted PTFE Hose	939B Convuluted PTFE Hose with Static-Dissipative Tube	944B High Pressure PTFE Hose with Static-Dissipative Tube	955B High Pressure PTFE Hose with Static-Dissipative Tube
 A-63	 A-63	 A-64	 A-65

PAGE Product Line PTFE & Specialty	STW "True-Bore" with SS Braid	STB Static-Dissipative "True-Bore" with SS Braid
	 A-66	 A-66
	SCW Convuluted with SS Braid	SCB Convuluted with SS Braid
	 A-67	 A-67
	SCWV Heavy Wall Convuluted with SS Braid	SCBV Static-Dissipative H.W. Convuluted with SS Braid
	 A-68	 A-68
	NCW Convuluted with Nomex Braid	NCB Static-Dissipative Convuluted w/Nomex Braid
 A-69	 A-69	

Understanding Parflex Hoses

Parflex hoses are designed to handle extremes. They are used in some of the harshest applications around, such as over-the-sheave or aerial lift, because they are specifically designed to handle extreme abrasion, temperatures, flexing, impulse and other factors that cause many hoses to fail.

Hydraulic & Pneumatic Hose Selection

Parflex offers several lines of hydraulic and pneumatic hoses; General Hydraulic, Specialty and Hybrid® hoses. Specialty hoses were designed to solve specific application problems. Hybrid® Hoses belong specifically to Parflex, with no exact competitor equivalents. These hoses were developed to cross typical SAE boundaries and meet specific challenges our customers were bringing to us. Some of these have the new, **TOUGHJACKET™** abrasion resistant cover, offering 100x the abrasion protection of a regular polyurethane cover.

The visual index and hose pages indicate which hoses are Hybrid® and **TOUGHJACKET™** designs.

Review the STAMPED guide (Size, Temperature, Media, Application, Pressure, End Configuration, and Delivery Preferences) on page 13 to help narrow your search for the desired product.

Fluoropolymer Selection

Parflex offers two lines of Fluoropolymer Hoses; the traditional Parflex PTFE hoses, many that meet 100R14 standards, and the PAGE hose line, comprised of specialty braid and construction options.

Hoses in PAGE product line are manufactured with materials that are compliant to the following standards:

- FDA 21 CFR 177.1550
- USP Class VI
- ISO 10093, Sections 5, 6 10 and 11

The visual index and hose pages indicate which hoses are from the PAGE product line.

Hose Assemblies

To determine hose part numbers for assemblies use the following nomenclature pages:

- Parflex Thermoplastic Hose Assembly Nomenclature pg. A-18
- Parflex PTFE Hose Assembly Nomenclature pg. A-20
- PAGE Product Line - "True-Bore" & Convuluted Hose Assembly Nomenclature pg. A-21

How to Read the Hose Section

1 Part Number	2 Nominal I.D.		3 Maximum O.D.		4 Maximum Working Pressure		5 Minimum Bend Radius		6 Weight		7 Permanent Fitting Series
#											
	inch	mm	inch	mm	psi	MPa	inch	mm	lbs./ft.	kg./mtr.	
594TJ-4	1/4	6.3	0.49	12.5	4,061	28.0	1.75	45	0.13	0.19	56

Base part number example.

NOTE: The primary dimensions are in black. The metric/inch equivalents appear in blue.

1 Part Number

Hose Series Part Number - When two part numbers are listed, the second number is the static-dissipative or non-conductive design.

2 Inside Diameter

A critical value along with pressure when calculating fluid flow rate and pressure drop.

3 Outside Diameter

A critical measurement when considering hose fittings and applications where envelope size is limited.

4 Working Pressure

Working pressure rating must meet or exceed the maximum operating pressure of the system including pressure spikes.

5 Minimum Bend Radius

Minimum radius that the hose can be bent. Exceeding the bend radius can cause kinking, inner tube washout, or excessive stress on reinforcement resulting in shortened service life.

6 Weight

Provided where weight is a critical parameter in the design of the system.

7 Approved Fitting

Permanent or field attachable fitting series approved for selected hose. Products with no fitting selection are only available in factory built assemblies.

Hose Constructions

Thermoplastic Hose Construction

1. Core

Contains Media

Materials: Nylon, Polyethylene, Polyurethane, Copolyester

2. Reinforcement

Provides Resistance to Internal Pressure

Materials: Fiber (Nylon, Polyester, Aramid), Steel, Stainless Steel

3. Cover

Protects Reinforcement

Advantages: Aesthetics, Color and Marking

Materials: Polyurethane, Nylon, Synthetic Rubber, and Copolyester

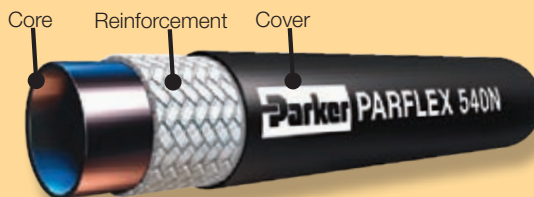

TOUGHJACKET™ Covers



Manufactured from Parflex **TOUGHJACKET™** Polyurethane and designed to withstand the strains of demanding use. Look for the TJ - Currently found on 560TJ, 563TJ, 590TJ and 594TJ.

Fluoropolymer Hose Construction

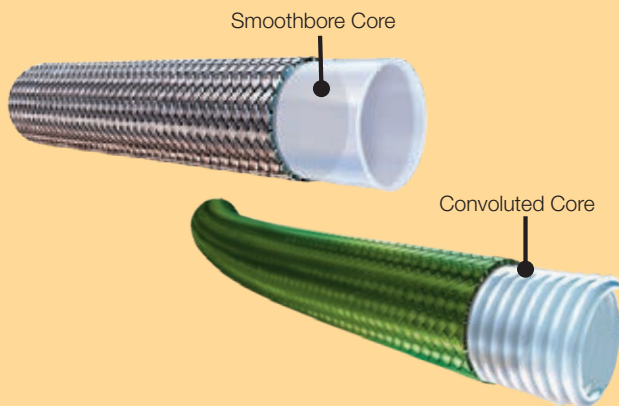

1. Core

Contains Media

Materials: PTFE

Style: Smoothbore or Convoluted

2. Reinforcement

Provides Resistance to Internal Pressure

Materials: Steel, Stainless Steel and Nomex®

3. Cover or Protective Sleeve

Protects Reinforcement

Materials: Silicone, Polyolefin

Nomex® is a registered trademark of E. I. du Pont de Nemours and Company.

Thermoplastic Hose Selection psi

Reinforcement Type		PSI Thermoplastic Hose Working Pressures												
		3/32	1/8	3/16	1/4	5/16	3/8	1/2	5/8	3/4	1	1 1/4	1 1/2	
Dash Size		-1.5	-2	-3	-4	-5	-6	-8	-10	-12	-16	-20	-24	
Hose	Description	psi	psi	psi	psi	psi	psi	psi	psi	psi	psi	psi	psi	
Wire	CNGRP* Regulated Pressure CNG								500	500				
	D6R/D6RX Hybrid® - Constant Pressure Hydraulic				3045	3045	3045	3045	3045	3045	3045			
	H6 Constant Pressure Hydraulic				3000	3000	3000	3000	3000	3000				
	HFSR Hybrid® - General Hydraulic				3263	3118	2611	2500		1523	1276			
	HFS2R Hybrid® - General Hydraulic				5000		4000	3500	2750	2250	2000			
	R6 Constant Pressure Hydraulic				3000		3000	3000	3000	3000				
	HTB Hybrid® - Compact High Pressure				7000		5500	5000	4000	4000	3500			
	560TJ General Hydraulic TOUGHJACKET™			3626	3263	3118	2750	2500	2000	1750				
	563TJ Constant Pressure TOUGHJACKET™				3045		3045	3045						
	590TJ General Hydraulic TOUGHJACKET™				5076		4061	3553		2500	2030			
	594TJ Constant Pressure TOUGHJACKET™				4061		4061	4061	4061					
	510A Industrial Refrigerant			3000	2750									
	Fiber	510C General Hydraulic		2500	3250	3000	2500	2250	2250		1250	1000		
518C Non-conductive Hydraulic			2500**	3250**	3000**	2500**	2250**	2250**		1250**	1000**			
518D Non-conductive Hydraulic			3000**	3250**	3000**	2500**	2250**	2250**		1250**				
515H Compact/Lightweight Hydraulic					2000		1500							
520N / 528N General Hydraulic / Non-conductive Hydraulic				5000	5000	4500	4000	3500						
527BA Breathing Air Refill				7000	7000									
53DM Low Temperature Hydraulic					3000		3000	3000	3000	3000				
538DM Low Temperature Hydraulic, Non-Conductive							3000							
540N General Hydraulic			3000	3000	2750	2500	2250	2000		1250				
540P Specialty Water					2750		2250	2000						
55LT Low Temperature Hydraulic			3000	3250	3000	2500	2250	2000						
56DH Diagnostic		6000	6000											
575X/575XN Fast Response Hydraulic				5000	5000		5000	5000		5000	5000			
580N / 588N General Hydraulic / Non-conductive Hydraulic								3500	2750	2250	2000			
H580N General Hydraulic											3000			
1035HT Power Cleaning					1750									
83FR General Purpose Air/Water					300		300	300		300				
B9 General Purpose Transfer				250	250	250	250	250	250					
5CNG Compressed Natural Gas					5000		5000	5000		5000	5000			
HLB Lubrication			3000	3000										
MSH Marine Steering					1000	1000								
MSXL H.P. Marine Steering					1500									
PTH Power Tilt			3000											
S5N Sewer Cleaning - Lateral Cleaning							4000							
S6 Sewer Cleaning									2500	2500				
S9 Sewer Cleaning									3000	3000				

* Sizing for -10 is 1/2"; for -12 is 5/8"

**View actual hose chart for ANSI pressure ratings

- Legend**
- F - Fiber
 - H - Copolyester
 - U - Polyurethane
 - N - Nylon
 - O - Polyethylene
 - UTJ - TOUGHJACKET™ Polyurethane
 - R - Smooth Synthetic Rubber
 - S - Silicone
 - X - TPV

Construction/Specifications

A
Hose

PSI Thermoplastic Construction and Specifications								Reinforcement Type
Core Tube	Reinforcement Material	Cover Material	SAE Specification	Additional Specifications	Page #	Description	Hose	
N	Wire	X	-	ANSI CSA NGV 3.1; NFPA 52; CSA 12.3, Class C	A-50	Regulated Pressure CNG	CNGRP	Wire
H	Wire	R	100R17	MSHA/ ISO 11237 Type R17	A-22	Hybrid® - Constant Pressure Hydraulic	D6R/D6RX	
H	Wire	H	100R17		A-25	Constant Pressure Hydraulic	H6	
H	Wire	R	100R1AT		A-23	Hybrid® - General Hydraulic	HFSR	
H	Wire	R	-	MSHA	A-24	Hybrid® - General Hydraulic	HFS2R	
H	Wire	F	100R17		A-26	Constant Pressure Hydraulic	R6	
H	Wire	R		MSHA	A-27	Hybrid® - Compact High Pressure	HTB	
H	Wire	UTJ	100R1AT	MSHA	A-28	General Hydraulic TOUGH JACKET™	560TJ	
H	Wire	UTJ	100R17	MSHA	A-29	Constant Pressure TOUGH JACKET™	563TJ	
H	Wire	UTJ		MSHA	A-30	General Hydraulic TOUGH JACKET™	590TJ	
H	Wire	UTJ	100R19	MSHA	A-31	Constant Pressure TOUGH JACKET™	594TJ	
U	Fiber	U	100R7	MSHA***	A-32	Industrial Refrigerant	510A	
H	Fiber	U	100R7***	MSHA***, DNV	A-33	General Hydraulic	510C	
H	Fiber	U	100R7***	ANSI A92.2, DNV	A-34	Non-conductive Hydraulic	518C	
N	Fiber	U	100R7	ANSI A92.2, DNV	A-35	Non-conductive Hydraulic	518D	
H	Fiber	U	-	MSHA	A-36	Compact/Lightweight Hydraulic	515H	
N	Fiber	U	100R8	MSHA***, DNV	A-37	General Hydraulic / Non-conductive Hydraulic	520N / 528N	
N	Fiber	U	-	CGA / NFPA 1901	A-38	Breathing Air Refill	527BA	
H	Fiber	H	100R18		A-39	Low Temperature Hydraulic	53DM	
H	Fiber	H	100R18		A-39	Low Temperature Hydraulic, Non-Conductive	538DM	
N	Fiber	U	100R7	MSHA	A-40	General Hydraulic	540N	
O	Fiber	U	100R7	FDA	A-41	Specialty Water	540P	
H	Fiber	H	100R7		A-42	Low Temperature Hydraulic	55LT	
N	Fiber	U	-	MSHA***	A-43	Diagnostic	56DH	
N	Fiber	U	-	MSHA***, DNV	A-44	Fast Response Hydraulic	575X/575XN	
N	Fiber	U	100R8	MSHA, DNV	A-45	General Hydraulic / Non-conductive	580N / 588N	
N	Fiber	U	100R8	DNV	A-45	General Hydraulic	H580N	
N	Fiber	U	-		A-47	Power Cleaning	1035HT	
U	Fiber	U	UL94HB	MSHA	A-46	General Purpose Air/Water	83FR	
U	Fiber	U	-		A-48	General Purpose Transfer	B9	
N	Fiber	U	-	ANSI CSA NGV 4.2; ECE R110***; NFPA 52; CSA 12.52 Class A, Class D, Class B***	A-49	Compressed Natural Gas	5CNG	
H	Fiber	U	-	MSHA	A-51	Lubrication	HLB	
N	Fiber	U	-		A-52	Marine Steering	MSH	
N	Fiber	U	-		A-53	H.P. Marine Steering	MSXL	
N	Fiber / SS Wire	U	-		A-54	Power Tilt	PTH	
N	Fiber	U	-	Wastec / NSWMA / WEMI	A-55	Sewer Cleaning - Lateral Cleaning	S5N	
H	Fiber	U	-	Wastec / NSWMA / WEMI	A-56	Sewer Cleaning	S6	
H	Fiber	U	-	Wastec / NSWMA / WEMI	A-57	Sewer Cleaning	S9	

***View Government & Agency Specifications for exceptions, pg. G-55

B
Tubing

C
Coiled Air Hose & Fittings

D
Transportation

E
Fittings

F
Tooling, Equipment & Accessories

G
General Technical

Fluoropolymer Hose Selection psi

Reinforcement Type		PSI Fluoropolymer Hose Working Pressures														
		Fractional Size	Nominal Sizes													
			1/8	3/16	1/4	5/16	13/32	1/2	5/8	7/8	1-1/8	1/8	1/4	3/8	1/2	5/8
		Dash Size	-3	-4	-5	-6	-8	-10	-12	-16	-20	-3	-4	-6	-8	-10
		psi	psi	psi	psi	psi	psi	psi	psi	psi	psi	psi	psi	psi	psi	
Wire	919	PTFE Hose	3000	3000	3000	2500	2000	1500	1200	1000	625					
	919B	PTFE Hose with static-dissipative core		3000	3000	2500	2000									
	919J	Silicone Covered PTFE Hose		3000	3000	2500	2000	1500	1200	1000						
	919U	High Abrasion Resistance PTFE Hose		3000		2500	2000		1200	1000						
	929	Heavy Wall PTFE Hose		3000		2500	2000									
	929B	Heavy Wall PTFE Hose with static-dissipative core		3000		2500	2000		1200	1250						
	929BJ	Silicone Covered PTFE Hose with static-dissipative core		3000		2500	2000		1200	1250						
	939	Convuluted PTFE Hose												1500	1350	1000
	939B	Convuluted PTFE Hose with static-dissipative core												1500	1350	1000
	944B	High Pressure PTFE Hose with static-dissipative core		4500		4500	4500	4500	4500	4000						
	955B	High Pressure PTFE Hose with static-dissipative core		5500		5500	5500	5500	5500	5500						
	STW Z-STW*	PAGE Heavy Wall PTFE Hose *Double Braid										3000	3000	2000	1750	
	STB Z-STB*	PAGE Heavy Wall PTFE Hose with static-dissipative core *Double Braid										3000	3000	2000	1750	
	SCW	PAGE Convuluted PTFE Hose											1500	1500	1500	
	SCB	PAGE Convuluted PTFE Hose with static-dissipative core											1500	1500	1500	
	SCWV	PAGE Heavy Wall Convuluted PTFE Hose													1500	
	SCBV	PAGE Heavy Wall Convuluted PTFE Hose with static-dissipative core													1500	
	Other	NCW	PAGE Nomex Braid Convuluted												725	400
NCB		PAGE Nomex Braid Convuluted with static-dissipative core												725	400	280

*Z indicates double braid for sizes over 1".

Legend

PTFE – Polytetrafluoroethylene PTFE-S – Polytetrafluoroethylene, Static Dissipative U – Polyurethane
 NB - Nomex Braid S – Silicone

Construction/Specifications

A
Hose

PSI Fluoropolymer Construction and Specifications														Reinforcement Type	
3/4	1	1 1/4	1 1/2	2	2-1/2	3	4					Fractional Size			
-12	-16	-20	-24	-32	-40	-48	-64	Core Tube	Reinforcement Material	Cover Material	Page #	Dash Size			
psi	psi	psi	psi	psi	psi	psi	psi								
								PTFE	SS Wire	—	A-58	PTFE Hose		919	
								PTFE-S	SS Wire	—	A-58	PTFE Hose with static-dissipative core		919B	
								PTFE	SS Wire	S	A-59	Silicone Covered PTFE Hose		919J	
								PTFE	SS Wire	U	A-60	High Abrasion Resistance PTFE Hose		919U	
								PTFE	SS Wire	—	A-61	Heavy Wall PTFE Hose		929	
								PTFE-S	SS Wire	—	A-61	Heavy Wall PTFE Hose with static-dissipative core		929B	
								PTFE-S	SS Wire	S	A-62	Silicone Covered PTFE Hose with static-dissipative core		929BJ	
	1100	1000	1000	750	250			PTFE	SS Wire	—	A-63	Convuluted PTFE Hose		939	
	1100	1000	1000	1000	1000			PTFE-S	SS Wire	—	A-63	Convuluted PTFE Hose with static-dissipative core		939B	
								PTFE-S	SS Wire	—	A-64	High Pressure PTFE Hose with static-dissipative core		944B	
								PTFE-S	SS Wire	—	A-65	High Pressure PTFE Hose with static-dissipative core		955B	
	1000	1000	1000*	900*				PTFE	SS Wire	—	A-66	PAGE Heavy Wall PTFE Hose *Double Braid		STW Z-STW*	
	1000	1000	1000*	900*				PTFE-S	SS Wire	—	A-66	PAGE Heavy Wall PTFE Hose with static-dissipative core *Double Braid		STB Z-STB*	
	1200	1000	750	650	450			PTFE	SS Wire	—	A-67	PAGE Convuluted PTFE Hose		SCW	
	1200	1000	750	650	450			PTFE-S	SS Wire	—	A-67	PAGE Convuluted PTFE Hose with static-dissipative core		SCB	
	1200	1000	750	650	450	200	175	150	PTFE	SS Wire	—	A-68	PAGE Heavy Wall Convuluted PTFE Hose		SCWV
	1200	1000	750	650	450	200	175	150	PTFE-S	SS Wire	—	A-68	PAGE Heavy Wall Convuluted PTFE Hose with static-dissipative core		SCBV
	200	200							PTFE	NB	—	A-69	PAGE Nomex® Braid Convuluted		NCW
	200	200							PTFE-S	NB	—	A-69	PAGE Nomex® Braid Convuluted with static-dissipative core		NCB

*Z indicates double braid for sizes over 1".

Nomex® is a registered trademark of E. I. du Pont de Nemours and Company.

B
Tubing

C
Coiled Air Hose & Fittings

D
Transportation

E
Fittings

F
Tooling, Equipment & Accessories

G
General Technical

Thermoplastic Hose Selection MPa

Reinforcement Type	MPa Thermoplastic Hose Working Pressures													
	Dash Size		3/32	1/8	3/16	1/4	5/16	3/8	1/2	5/8	3/4	1	1 1/4	1 1/2
	Hose	Description	MPa	MPa	MPa	MPa	MPa	MPa	MPa	MPa	MPa	MPa	MPa	MPa
Wire	CNGRP*	Regulated Pressure CNG								3.45	3.45			
	D6R/D6RX	Hybrid® - Constant Pressure Hydraulic				21.0	21.0	21.0	21.0	21.0	21.0	21.0		
	H6	Constant Pressure Hydraulic				20.7	20.7	20.7	20.7	20.7	20.7			
	HFSR	Hybrid® - General Hydraulic				22.5	21.5	18.0	17.2		10.5	8.8		
	HFS2R	Hybrid® - General Hydraulic				34.5		27.6	24.1	19.0	15.5	13.7		
	R6	Constant Pressure Hydraulic				20.7		20.7	20.7	20.7	20.7			
	HTB	Hybrid® - Compact High Pressure				48.3		37.9	34.5	27.6	27.6	24.1		
	560TJ	General Hydraulic TOUGHJACKET™			25.0	22.5	21.5	19.0	17.2	13.8	12.1			
	563TJ	Constant Pressure TOUGHJACKET™				21.0		21.0	21.0					
	590TJ	General Hydraulic TOUGHJACKET™				35.0		28.0	24.5		17.2	14.0		
	594TJ	Constant Pressure TOUGHJACKET™				28.0		28.0	28.0	28.0				
	Fiber	510A	Industrial Refrigerant			20.7	19.0							
510C		General Hydraulic		17.2	22.4	20.7	17.2	15.5	15.5		8.6	6.9		
518C		Non-conductive Hydraulic		17.2**	22.4**	21.0**	17.2**	15.5**	15.5**		8.7**	6.9**		
518D		Non-conductive Hydraulic		21.0**	22.4**	20.7**	17.2**	15.5**	15.5**		8.7**			
515H		Compact/Lightweight Hydraulic				13.8		10.3						
520N / 528N		General Hydraulic / Non-conductive Hydraulic			34.5	34.5	31.0	27.6	24.1	19.0				
527BA		Breathing Air Refill			48.3	48.3								
53DM		Low Temperature Hydraulic				20.7		20.7	20.7	20.7				
538DM		Low Temperature Hydraulic, Non-conductive						20.7						
540N		General Hydraulic		20.7	20.7	19.0	17.2	15.5	13.8		8.6			
540P		Specialty Water				19.0		15.5	13.8					
55LT		Low Temperature Hydraulic		20.7	22.4	20.7	17.2	15.5	13.8					
56DH		Diagnostic	41.4	41.4										
575X/575XN		Fast Response Hydraulic			34.5	34.5		34.5	34.5		34.5	34.5		
580N / 588N		General Hydraulic / Non-conductive Hydraulic							24.1	19.0	15.5	13.8		
H580N		General Hydraulic										20.7		
1035HT		Power Cleaning				12.1								
83FR		General Purpose Air/Water				2.1		2.1	2.1		2.1			
B9		General Purpose Transfer			1.7	1.7	1.7	1.7	1.7	1.7				
5CNG		Compressed Natural Gas				34.5		34.5	34.5		34.5	34.5		
HLB	Lubrication		20.7	20.7										
MSH	Marine Steering					6.9	6.9							
MSXL	H.P. Marine Steering					10.3								
PTH	Power Tilt			20.7										
S5N	Sewer Cleaning - Lateral Cleaning							27.6						
S6	Sewer Cleaning									17.2	17.2			
S9	Sewer Cleaning									20.7	20.7			

* Sizing for -10 is 1/2"; for -12 is 5/8"
 **View actual hose chart for ANSI pressure ratings

Legend F - Fiber H - Copolyester U - Polyurethane
 N - Nylon O - Polyethylene UTJ - TOUGHJACKET™ Polyurethane
 R - Smooth Synthetic Rubber S - Silicone X - TPV

Construction/Specifications

A
Hose

MPa Thermoplastic Construction and Specifications								Reinforcement Type
Core Tube	Reinforcement Material	Cover Material	SAE Specification	Additional Specifications	Page #	Description	Hose	
N	Wire	X	-	ANSI CSA NGV 3.1; NFPA 52; CSA 12.3, Class C	A-50	Regulated Pressure CNG	CNGRP	Wire
H	Wire	R	100R17	MSHA/ ISO 11237 Type R17	A-22	Hybrid® - Constant Pressure Hydraulic	D6R/D6RX	
H	Wire	H	100R17		A-25	Constant Pressure Hydraulic	H6	
H	Wire	R	100R1AT		A-23	Hybrid® - General Hydraulic	HFSR	
H	Wire	R	-	MSHA	A-24	Hybrid® - General Hydraulic	HFS2R	
H	Wire	F	100R17		A-26	Constant Pressure Hydraulic	R6	
H	Wire	R		MSHA	A-27	Hybrid® - Compact High Pressure	HTB	
H	Wire	UTJ	100R1AT	MSHA	A-28	General Hydraulic TOUGH JACKET™	560TJ	
H	Wire	UTJ	100R17	MSHA	A-29	Constant Pressure TOUGH JACKET™	563TJ	
H	Wire	UTJ		MSHA	A-30	General Hydraulic TOUGH JACKET™	590TJ	
H	Wire	UTJ	100R19	MSH***	A-31	Constant Pressure TOUGH JACKET™	594TJ	Fiber
U	Fiber	U	100R7	MSHA***	A-32	Industrial Refrigerant	510A	
H	Fiber	U	100R7***	MSHA***, DNV	A-33	General Hydraulic	510C	
H	Fiber	U	100R7***	ANSI A92.2, DNV	A-34	Non-conductive Hydraulic	518C	
N	Fiber	U	100R7	ANSI A92.2, DNV	A-35	Non-conductive Hydraulic	518D	
H	Fiber	U	-	MSHA	A-36	Compact/Lightweight Hydraulic	515H	
N	Fiber	U	100R8	MSHA***, DNV	A-37	General Hydraulic / Non-conductive Hydraulic	520N / 528N	
N	Fiber	U	-	CGA / NFPA 1901	A-38	Breathing Air Refill	527BA	
H	Fiber	H	100R18		A-39	Low Temperature Hydraulic	53DM	
H	Fiber	H	100R18		A-39	Low Temperature Hydraulic, Non-conductive	538DM	
N	Fiber	U	100R7	MSHA	A-40	General Hydraulic	540N	
O	Fiber	U	100R7	FDA	A-41	Specialty Water	540P	
H	Fiber	H	100R7		A-42	Low Temperature Hydraulic	55LT	
N	Fiber	U	-	MSHA***	A-43	Diagnostic	56DH	
N	Fiber	U	-	MSHA***, DNV	A-44	Fast Response Hydraulic	575X/575XN	
N	Fiber	U	100R8	MSHA, DNV	A-45	General Hydraulic / Non-conductive	580N / 588N	
N	Fiber	U	100R8	DNV	A-45	General Hydraulic	H580N	
N	Fiber	U	-		A-47	Power Cleaning	1035HT	
U	Fiber	U	UL94HB	MSHA	A-46	General Purpose Air/Water	83FR	
U	Fiber	U	-		A-48	General Purpose Transfer	B9	
N	Fiber	U	-	ANSI CSA NGV 4.2; ECE R110***; NFPA 52; CSA 12.52 Class A, Class D, Class B***	A-49	Compressed Natural Gas	5CNG	
H	Fiber	U	-	MSHA	A-51	Lubrication	HLB	
N	Fiber	U	-		A-52	Marine Steering	MSH	
N	Fiber	U	-		A-53	H.P. Marine Steering	MSXL	
N	Fiber / SS Wire	U	-		A-54	Power Tilt	PTH	
N	Fiber	U	-	Wastec / NSWMA / WEMI	A-55	Sewer Cleaning - Lateral Cleaning	S5N	
H	Fiber	U	-	Wastec / NSWMA / WEMI	A-56	Sewer Cleaning	S6	
H	Fiber	U	-	Wastec / NSWMA / WEMI	A-57	Sewer Cleaning	S9	

***View Government & Agency Specifications for exceptions, pg. G-55

B
Tubing

C
Coiled Air Hose & Fittings

D
Transportation

E
Fittings

F
Tooling, Equipment & Accessories

G
General Technical

Fluoropolymer Hose Selection MPa

Reinforcement Type		MPa Fluoropolymer Hose Working Pressures															
		Fractional Size	Nominal Sizes														
			1/8	3/16 15/64	1/4	5/16	13/32 7/16	1/2	5/8	7/8 29/32	1-1/8	1/8	1/4	3/8	1/2	5/8	
		Dash Size	-3	-4	-5	-6	-8	-10	-12.1	-16	-20	-3	-4	-6	-8	-10.3	
		MPa	MPa	MPa	MPa	MPa	MPa	MPa	MPa	MPa	MPa	MPa	MPa	MPa	MPa		
Wire	919	PTFE Hose	20.7	20.7	20.7	17.2	13.8	10.3	8.3	6.9	4.3						
	919B	PTFE Hose with static-dissipative core		20.7	20.7	17.2	13.8										
	919J	Silicone Covered PTFE Hose		20.7	20.7	17.2	13.8	10.3	8.3	6.9							
	919U	High Abrasion Resistance PTFE Hose		20.7		17.2	13.8		8.3	6.9							
	929	Heavy Wall PTFE Hose		20.7		17.2	13.8										
	929B	Heavy Wall PTFE Hose with static-dissipative core		20.7		17.2	13.8		8.3	9							
	929BJ	Silicone Covered PTFE Hose with static-dissipative core		20.7		17.2	13.8		8.3	9							
	939	Convolute PTFE Hose												10.3	9.3	6.9	
	939B	Convolute PTFE Hose with static-dissipative core												10.3	9.3	6.9	
	Other	944B	High Pressure PTFE Hose with static-dissipative core		31.0		31.0	31.0	31.0	31.0	27.5						
955B		High Pressure PTFE Hose with static-dissipative core		37.9		37.9	37.9	37.9	37.9	37.9							
STW Z-STW*		PAGE Heavy Wall PTFE Hose *Double Braid										20.7	20.7	13.8	12.1		
STB Z-STB*		PAGE Heavy Wall PTFE Hose with static-dissipative core *Double Braid										20.7	20.7	13.8	12.1		
SCW		PAGE Convolute PTFE Hose											10.3	10.3	10.3		
SCB		PAGE Convolute PTFE Hose with static-dissipative core											10.3	10.3	10.3		
SCWV		PAGE Heavy Wall Convolute PTFE Hose													10.3		
SCBV		PAGE Heavy Wall Convolute PTFE Hose with static-dissipative core													10.3		
NCW		PAGE Nomex Braid Convolute												725	400	280	
NCB		PAGE Nomex Braid Convolute with static-dissipative core												725	400	280	

*Z indicates double braid for sizes over 1".

Legend

- PTFE – Polytetrafluoroethylene
- PTFE-S – Polytetrafluoroethylene, Static Dissipative
- U – Polyurethane
- NB - Nomex Braid
- S – Silicone

Construction/Specifications

Hose
A

MPa Fluoropolymer Construction and Specifications														Reinforcement Type
3/4	1	1 1/4	1 1/2	2	2-1/2	3	4					Fractional Size		
-12.	-16	-20	-24	-32	-40	-48	-64	Core Tube	Reinforcement Material	Cover Material	Page #	Dash Size		
MPa	MPa	MPa	MPa	MPa	MPa	MPa	MPa							
								PTFE	SS Wire	—	A-58	PTFE Hose		919
								PTFE-S	SS Wire	—	A-58	PTFE Hose with static-dissipative core		919B
								PTFE	SS Wire	S	A-59	Silicone Covered PTFE Hose		919J
								PTFE	SS Wire	U	A-60	High Abrasion Resistance PTFE Hose		919U
								PTFE	SS Wire	—	A-61	Heavy Wall PTFE Hose		929
								PTFE-S	SS Wire	—	A-61	Heavy Wall PTFE Hose with static-dissipative core		929B
								PTFE-S	SS Wire	S	A-62	Silicone Covered PTFE Hose with static-dissipative core		929BJ
	7.6	6.9	6.9	5.2	1.7			PTFE	SS Wire	—	A-63	Convoluted PTFE Hose		939
	7.6	6.9	6.9	5.2	1.7			PTFE-S	SS Wire	—	A-63	Convoluted PTFE Hose with static-dissipative core		939B
								PTFE-S	SS Wire	—	A-64	High Pressure PTFE Hose with static-dissipative core		944B
								PTFE-S	SS Wire	—	A-65	High Pressure PTFE Hose with static-dissipative core		955B
	6.9	6.9 8.3*	6.9*	6.2*				PTFE	SS Wire	—	A-66	PAGE Heavy Wall PTFE Hose *Double Braid		STW Z-STW*
	6.9	6.9 8.3*	6.9*	6.2*				PTFE-S	SS Wire	—	A-66	PAGE Heavy Wall PTFE Hose with static-dissipative core *Double Braid		STB Z-STB*
	8.3	6.9	5.2	4.5	3.1			PTFE	SS Wire	—	A-67	PAGE Convoluted PTFE Hose		SCW
	8.3	6.9	5.2	4.5	3.1			PTFE-S	SS Wire	—	A-67	PAGE Convoluted PTFE Hose with static-dissipative core		SCB
	8.3	6.9	5.2	4.5	3.1	1.4	1.2	1.0	PTFE	SS Wire	—	PAGE Heavy Wall Convoluted PTFE Hose		SCWV
	8.3	6.9	5.2	4.5	3.1	1.4	1.2	1.0	PTFE-S	SS Wire	—	PAGE Heavy Wall Convoluted PTFE Hose with static-dissipative core		SCBV
	200	200							PTFE	NB	—	PAGE Nomex® Braid Convoluted		NCW
	200	200							PTFE-S	NB	—	PAGE Nomex® Braid Convoluted with static-dissipative core		NCB

*Z indicates double braid for sizes over 1".

Tubing
B

Coiled Air Hose & Fittings
C

Transportation
D

Fittings
E

Tooling, Equipment & Accessories
F

General Technical
G

Nomex® is a registered trademark of E. I. du Pont de Nemours and Company.

Parflex Thermoplastic Hoses

Parflex Thermoplastic Hose Assembly Nomenclature

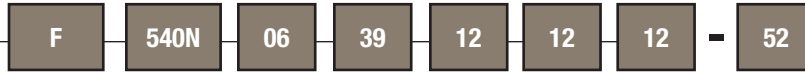

F	Prefix	540N	Hose			06-39	Fitting Configuration*
F – Parkrimp (i.e. 56 series) A – Factory Crimp (i.e. 54 series) R – Field Attachable (i.e. 51 series)		540N	1035HT	560TJ	H580N	06-39	01 – Male Pipe Thread (with hex) - NPTF 02 – Female Pipe Thread - NPT 03 – Male SAE (JIC) 37° Flare 05 – Male Straight Thread w/ O-Ring 06 – Female SAE (JIC) 37° Swivel 07 – Female Pipe Swivel 13 – Male Pipe Swivel - NPTF 37 – Female SAE (JIC) 37° Swivel - 45° Elbow 39 – Female SAE (JIC) 37° Swivel - 90° Elbow 41 – Female SAE (JIC) 37° Swivel - 90° Long Elbow JC – Female Seal-Lok™ (ORFS) Swivel Short FU – Female JIC/BSP 30° Flare Swivel MU – Metric Female JIC/BSP 30° Flare Swivel JO – Male Seal-Lok™ (ORFS) Rigid Strt w/O-Ring GU – Female JIC/BSP Parallel Pipe Swive (60° Cone) JS – Female Seal-Lok™ (ORFS) Swivel J7 – Female Seal-Lok™ (ORFS) Swivel - 45° Elbow J9 – Female Seal-Lok™ (ORFS) Swivel - 90° Elbow TU – Universal Tube Stub AL – A-Lok® Compression
			510A	563TJ	H6		
			510C	56DH	HFSR		
			515H	575X/575XN	HFS2R		
			518C	580N	HTB		
			518D	588N	MSH		
			520N	590TJ	MSXL		
			527BA	594TJ	PTH		
			528N	5CNG	R6		
			53DM/538DM	83FR	S5N		
			540N	B9	S6		
			540P	CNGRP	S9		
			55LT	D6R/D6RX			

* See pg. E-4 for detailed list of available fitting configurations.



12	Connection Size 1	12	Connection Size 2	12	Hose Size	C	Fitting Material
	-2 = 1/8		-2 = 1/8		-2 = 1/8		** No Material Designation, Steel C = Stainless Steel
	-3 = 3/16		-3 = 3/16		-3 = 3/16		
	-4 = 1/4		-4 = 1/4		-4 = 1/4		
	-5 = 5/16		-5 = 5/16		-5 = 5/16		
	-6 = 3/8		-6 = 3/8		-6 = 3/8		
	-8 = 1/2		-8 = 1/2		-8 = 1/2		
-10 = 5/8	-10 = 5/8	-10 = 5/8					
-12 = 3/4	-12 = 3/4	-12 = 3/4					
-16 = 1	-16 = 1	-16 = 1					
-20 = 1-1/4	-20 = 1-1/4	-20 = 1-1/4					

52	Overall Length
	Expressed in inches

NOTE: Face Seal type fittings are measured from sealing face.

##	Displacement Angle
	Specified only if two elbow fittings are used to construct hose assembly.*

*Starting with either end as the far end, measure the angle clockwise to describe the displacement of the near end.

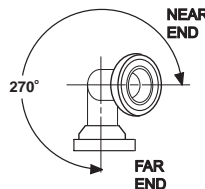

Parflex PTFE Hoses

Parflex PTFE Hose Assembly Nomenclature



P	919	Hose		06-39	Fitting Configuration*
Prefix P – Permanent Crimp (i.e. 91N series) R – Field Attachable (i.e. 90 series) Factory Crimp (i.e. 94 series)		Natural	Static Dissipative	06-39	Fitting Configuration* 01 – Male Pipe Thread (with hex) - NPTF 02 – Female Pipe Thread - NPT 03 – Male SAE (JIC) 37° Flare 05 – Male Straight Thread w/ O-Ring 06 – Female SAE (JIC) 37° Swivel 07 – Female Pipe Swivel 37 – Female SAE (JIC) 37° Swivel - 45° Elbow 39 – Female SAE (JIC) 37° Swivel - 90° Elbow 41 – Female SAE (JIC) 37° Swivel - 90° Long Elbow JC – Female Seal-Lok™ (ORFS) Swivel Short FU – Female JIC/BSP 30° Flare Swivel MU – Metric Female JIC/BSP 30° Flare Swivel GU – Female JIC/BSP Parallel Pipe Swive (60° Cone) JS – Female Seal-Lok™ (ORFS) Swivel J7 – Female Seal-Lok™ (ORFS) Swivel - 45° Elbow J9 – Female Seal-Lok™ (ORFS) Swivel - 90° Elbow TU – Universal Tube Stub AL – A-Lok® Compression
		919	919B		
		919J	929BJ		
		919U	–		
		929	929B		
		939	939B		
		–	944B		
		955B			

* See pg. E-4 for detailed list of available fitting configurations.

06	06	06	C	30
Connection Size 1 -4 = 1/4 -5 = 5/16 -6 = 3/8 -8 = 1/2 -10 = 5/8 -12 = 3/4 -16 = 1 -20 = 1-1/4 -24 = 1-1/2 -32 = 2	Connection Size 2 -4 = 1/4 -5 = 5/16 -6 = 3/8 -8 = 1/2 -10 = 5/8 -12 = 3/4 -16 = 1 -20 = 1-1/4 -24 = 1-1/2 -32 = 2	Hose Size -4 = 1/4 -5 = 5/16 -6 = 3/8 -8 = 1/2 -10 = 5/8 -12 = 3/4 -16 = 1 -20 = 1-1/4 -24 = 1-1/2 -32 = 2	Fitting Material ** No Material Designation C = Stainless Steel B = Brass (91N) S = All Steel (91N)	Overall Length Expressed in Inches OAL measured from centerline of fitting seat if elbow fittings are used.

NOTE: Face Seal type fittings are measured from sealing face.

Displacement Angle

Specified only if two elbow fittings are used to construct hose assembly.*

*Starting with either end as the far end, measure the angle clockwise to describe the displacement of the near end.

Parflex PAGE PTFE Product Line

“True-Bore” & Convoluted Hose Assembly Nomenclature

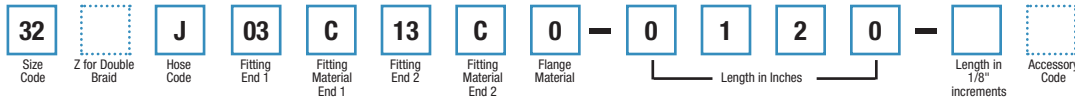
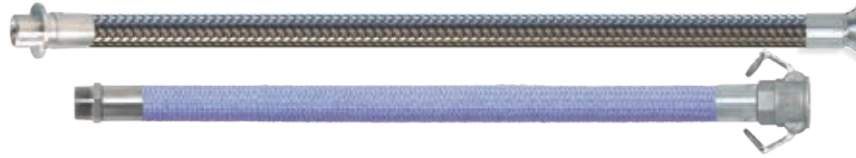

Size Code	
1/4"	04
5/16"	05
3/8"	06
1/2"	08
5/8"	10
3/4"	12
7/8"	14
1"	16
1-1/4"	20
1-1/2"	24
2"	32
2-1/2"	40
3"	48
4"	64

Hose Code	
hose	code
CWV	V
NCB	MB
NCW	M
SCB	TB
SCBV	JB
SCW	T
SCWV	J
STB	SB
STW	S

Fitting Code	
Industrial Thread	
Male Pipe NPT Hex	03
Female Pipe NPT Hex	06
Male Pipe NPT Step Down	13
Male Pipe NPT Step Up	23
Male Union Step Up	34
Male Union Step Down	35
JIC Female Swivel	30
Male JIC 37°	31
JIC Female Step Up	32
Male Union	33
Female Union	36
Female NPSH	27
Female ORFS Swivel	80
Male ORFS	81
Male O-Ring Boss	86
Flanges	
Flange Retainer	05
Flare-Seal® Flange Retainer	29
Cam Lock	
Female Cam Lock	07
With Locking Handles	17
Male Cam Lock	08
Sanitary	
Sanitary Tri Clamp	40
Sanitary Tri Clamp 45°	4K
Sanitary Tri Clamp 90°	4L
Sanitary 1-Step Up	4A
Sanitary 2-Step Up	4B
Sanitary 3-Step Up	4C
Sanitary Flare Seal™	4F
Sanitary Mini	42
Sanitary Mini Step Up	43
I-Line Male	48
I-Line Female	49
Bevel Seat Female	45
Bevel Seat Male	46
Tube and Vacuum	
PAGElok™ Tube Adapter	38
PAGElok™ Tube Compression Fitting	39
Special Ends	
Standard Cuffed Ends	90
Non Standard Fitting	99

Fitting Material	
304 Stainless (SS 304)	4
316 Stainless (SS 316)	6
316 Stainless (SS 15Ra) Electropolished to 15Ra	E
Steel	C
PFA Encapsulated	T
Hastelloy	H
Monel	M

Flange Material	
None	0
Carbon Steel	D
Epoxy Coated	
304SS	4
316SS	6
Kynar	K
Polypropylene	P
Non Standard	X

Accessory Code	
None	
Spring Guard	S
Armour Guard	A
End Bend Restrictors	E
Fire Sleeve	F
Rubber Sleeve	H
FEP Heat Shrink	T
Polyolefin Heat Shrink	P
Silicone Sleeve	M
Vacuum Spring Wire	W
Specials	X

Example: 32J03C13C0-0120-A

Size: 2" **Style:** SCWV

Braid: 316 SS Single Braid

Core: Heavy Wall Open Pitch Convoluted PTFE

End 1: 2" Male Pipe NPT Hex

End 2: 2" Male Pipe NPT Step Down

Length: 120" from end of Male NPT to end of Male Step Down

NOTE: Length calculations for PAGE hose assemblies are typically made sealing surface to sealing surface per the NAHAD Fluoropolymer Hose Assembly Specification Guidelines unless otherwise requested by customer at time of order.

The part numbering system shows the entire product line offered by the Parker PAGE International business unit. This catalog section only displays a few common hoses.

D6R/D6RX – Hybrid® Hose



Features

- Up to 40% lighter than comparable rubber hoses
- Wide range of fluid compatibility

Compact hose Construction

- Bend radius less than half of conventional SAE 100R1AT and 100R2 hoses
- UV resistant cover
- Low force to flex
- 3,000 psi working pressure

Applications/Markets



- Medium pressure hydraulic applications
- Agricultural Equipment
- Construction Equipment
- Lubricating Oils
- Transportation

Certifications

- Meets/Exceeds ISO 11237 Type R17 Pressure requirements
- Meets/Exceeds SAE 100R17 Performance
- MSHA accepted

[Visit the webpage](#)

Part Number	Nominal I.D.		Maximum O.D.		Maximum Working Pressure		Minimum Bend Radius		Weight		Permanent Fitting Series
	inch	mm	inch	mm	psi	MPa	inch	mm	lbs./ft.	kg./m.	
#											
D6R04*	1/4	6.4	.46	11.7	3,045	21.0	1.50	38	0.10	0.14	56
D6R05	5/16	7.9	.52	13.2	3,045	21.0	1.75	45	0.12	0.18	56
D6R06*	3/8	9.5	.61	15.5	3,045	21.0	2	51	0.17	0.25	56
D6R08*	1/2	12.7	.76	19.3	3,045	21.0	3	76	0.26	0.38	56
D6R10	5/8	15.9	.97	24.6	3,045	21.0	3.50	89	0.43	0.64	56
D6R12	3/4	19.1	1.14	29.0	3,045	21.0	4.25	108	0.71	1.06	56
D6R16	1	25.4	1.45	36.8	3,045	21.0	5.91	150	0.91	1.36	56

Construction

Tube: Copolyester

Reinforcement: High Tensile Steel Wire

Cover: Smooth Synthetic Rubber

Fittings

56 Series – pg. E-13

For most Parker products, Crimp Die Selection charts can be found online at www.parker.com/crimpsource

Access instructions are on pg. G-14

Operating Parameters

Temperature Range:

- Petroleum base hydraulic fluids and lubricating oils within a temperature range -40°F (-40°C) to +250°F (121°C)
- Synthetic, synthetic blend, water, and water/oil emulsion hydraulic fluids limited to +185°F (+85°C)
- Water/glycol hydraulic fluids limited to +135°F (+57°C)

Vacuum Rating: 28 inch Hg

Change in length at Max. Working Pressure: +2% to -4%

Min. Burst Pressure is 4x Max. Working Pressure at 73°F (23°C)

Color

- Black

Notes

* X designates a continuous, long length reel (ie D6RX04)



WARNING

This product can expose you to chemicals including Lead, which is known to the State of California to cause cancer and birth defects or other reproductive harm. For more information go to www.P65Warnings.ca.gov.

HFSR Hybrid® Hose with Rubber Cover



Features

- Up to 40% lighter than comparable rubber hoses
- Wide range of fluid compatibility

Compact hose Construction

- Bend radius less than half of conventional SAE 100R1AT hoses
- UV resistant cover
- Low force to flex

Certifications

- Meets/Exceeds SAE 100R1AT Performance
- Meets/Exceeds ISO 1436 Type 1SN Pressure requirements

Applications/Markets



- Industrial
- Construction
- Waste & Refuse
- Utility Equipment
- Paving and road maintenance

[Visit the webpage](#)

Part Number	Nominal I.D.		Maximum O.D.		Maximum Working Pressure		Minimum Bend Radius		Weight		Permanent Fitting Series
	inch	mm	inch	mm	psi@73°C	MPa@23°F	inch	mm	lbs./ft.	kg./m.	
#											
HFSR04	1/4	6.4	.46	11.7	3,263	22.5	1.50	38	0.10	0.14	56
HFSR05	5/16	7.9	.52	13.2	3,118	21.5	1.75	45	0.12	0.18	56
HFSR06	3/8	9.5	.61	15.5	2,611	18.0	2	51	0.17	0.25	56
HFSR08	1/2	12.7	.74	18.8	2,500	17.2	3	76	0.21	0.32	56
HFSR12	3/4	19.1	1.02	25.9	1,523	10.5	4.25	108	0.31	0.46	56
HFSR16	1	25.4	1.31	33.3	1,276	8.8	7.50	191	0.44	0.66	56

Construction

Tube: Copolyester

Reinforcement: High Tensile Steel Wire

Cover: Smooth Synthetic Rubber

Operating Parameters

Temperature Range:

- Petroleum base hydraulic fluids and lubricating oils within a temperature range -40°F (-40°C) to +250°F (121°C)
- Synthetic, synthetic blend, water, and water/oil emulsion hydraulic fluids limited to +185°F (+85°C)
- Water/glycol hydraulic fluids limited to +135°F (+57°C)

Vacuum Rating: 28 inch Hg

Change in length at Max. Working Pressure: +2% to -4%

Min. Burst Pressure is 4x Max. Working Pressure at 73°F (23°C)

Fittings

56 Series – pg. E-13

For most Parker products, Crimp Die Selection charts can be found online at www.parker.com/crimpsource

Access instructions are on pg. G-14

Color

- Black



WARNING

This product can expose you to chemicals including Chloroprene, which is known to the State of California to cause cancer. For more information go to www.P65Warnings.ca.gov.

HFS2R Hybrid[®] Hose with Rubber Cover



Features

- Up to 40% lighter than comparable rubber hoses
- Wide range of fluid compatibility
- Compact hose Construction
- Bend radius less than half of conventional 100R2 hoses
- UV resistant cover
- Low force to flex

Certifications

- MSHA Accepted

Applications/Markets



- Medium pressure hydraulic applications
- Mobile Equipment
- Machine Tools
- Agricultural Equipment

[Visit the webpage](#)

Part Number	Nominal I.D.		Maximum O.D.		Maximum Working Pressure		Minimum Bend Radius		Weight		Permanent Fitting Series
	inch	mm	inch	mm	psi	MPa	inch	mm	lbs./ft.	kg./mtr.	
#											
HFS2R04*	1/4	6.4	.49	12.4	5,000	34.5	2.00	51	.21	.31	56
HFS2R06	3/8	9.5	.64	16.3	4,000	27.6	2.50	64	.23	.34	56
HFS2R08	1/2	12.7	.76	19.3	3,500	24.1	3.50	89	.29	.43	56
HFS2R10	5/8	15.9	.93	23.6	2,750	19.0	4.00	102	.38	.57	56
HFS2R12	3/4	19.1	1.07	27.2	2,250	15.5	4.75	121	.45	.67	56
HFS2R16*	1	25.4	1.40	35.6	2,000	13.8	6.00	152	.80	1.19	56

Construction

Tube: Copolyester

Reinforcement: One or two braids of High Tensile Steel Wire

Cover: Smooth Synthetic Rubber

Fittings

56 Series - pg. E-13

For most Parker products, Crimp Die Selection charts can be found online at www.parker.com/crimpsource

Access instructions are on pg. G-14

Operating Parameters

Temperature Range:

- Petroleum base hydraulic fluids and lubricating oils within a temperature range -40°F (-40°C) to +212°F (100°C)
- Synthetic, synthetic blend, water, and water/oil emulsion hydraulic fluids limited to +185°F (+85°C)
- Water/glycol hydraulic fluids limited to +135°F (+57°C)

Vacuum Rating: 28 inch Hg

Change in length at Max. Working Pressure: +2% to -4%

Min. Burst Pressure is 4x Max. Working Pressure at 73°F (23°C)

Colors

- Black

Notes

- *Two wire braid



WARNING

This product can expose you to chemicals including Chloroprene, which is known to the State of California to cause cancer. For more information go to www.P65Warnings.ca.gov.

H6 – Hydraulic Hose, Constant Pressure 3,000 psi



Features

- Largest temperature range in a medium pressure hydraulic hose
- Low length change under pressure

Certifications

- Meets/Exceeds SAE 100R17 Performance

Applications/Markets



- Medium pressure hydraulic applications
- Over-the-sheave and boom hose applications



[Visit the webpage](#)

Part Number	Nominal I.D.		Maximum O.D.		Maximum Working Pressure		Minimum Bend Radius		Weight		Permanent Fitting Series
	inch	mm	inch	mm	psi	MPa	inch	mm	lbs./ft.	kg./mtr.	
#											
H604	1/4	6.4	.49	12.4	3,000	20.7	2.00	51	.12	.18	56
H605	5/16	7.9	.56	14.2	3,000	20.7	2.25	57	.14	.21	HY
H606	3/8	9.5	.65	16.5	3,000	20.7	2.50	64	.19	.28	56
H608	1/2	12.7	.78	19.8	3,000	20.7	3.50	89	.29	.43	56
H610*	5/8	15.9	1.00	25.4	3,000	20.7	4.00	102	.47	.70	HY
H612*	3/4	19.1	1.17	29.7	3,000	20.7	4.75	121	.69	1.03	HY

Construction

Tube: Copolyester

Reinforcement: One or two braids of High Tensile Steel Wire

Cover: Abrasion-resistant Copolyester

Operating Parameters

Temperature Range:

- (H604 thru H608) -70°F (-57°C) to +250°F (121°C)
(H610 thru H612) -50°F (-45°C) to +250°F (121°C)
- Synthetic, synthetic blend, water, and water/oil emulsion hydraulic fluids limited to +135°F (+57°C)

Vacuum Rating: 28 inch Hg

Change in length at Max. Working Pressure: +2% to -4%

Min. Burst Pressure is 4x Max. Working Pressure at 73°F (23°C)

Fittings

56 Series - pg. E-13 HY Series

HY Series - Available from Parker Hose Products Division

For most Parker products, Crimp Die Selection charts can be found online at www.parker.com/crimpsource

Access instructions are on pg. G-14

Colors

- Black

Notes

- *Two wire braid
- Twin line hose available
- Preformed assemblies
- Non-Perforated Cover



[READ THE BLOG](#)



WARNING

This product can expose you to chemicals including Nickel compounds, which is known to the State of California to cause cancer. For more information go to www.P65Warnings.ca.gov.

R6 – Abrasion King® Hose, Constant Pressure 3,000 psi



Features

- Light weight
- Excellent flexibility
- Excellent abrasion resistance
- Blue plait provides hose identification

Certifications

- Meets/Exceeds SAE 100R17 Performance

Applications/Markets



- Medium pressure hydraulic applications
- Agricultural Equipment



[Visit the webpage](#)

Part Number	Nominal I.D.		Maximum O.D.		Maximum Working Pressure		Minimum Bend Radius		Weight		Permanent Fitting Series
	inch	mm	inch	mm	psi	MPa	inch	mm	lbs./ft.	kg./mtr.	
#											
R604	1/4	6.4	.53	13.5	3000	20.7	2.00	51	.11	.16	HY
R606	3/8	9.5	.69	17.5	3000	20.7	2.50	64	.20	.30	HY
R608	1/2	12.7	.84	21.3	3000	20.7	3.50	89	.27	.40	HY
R610*	5/8	15.9	1.09	27.7	3000	20.7	4.00	102	.51	.76	HY
R612*	3/4	19.1	1.24	31.5	3000	20.7	4.75	121	.71	1.06	HY

Construction

Tube: Copolyester

Reinforcement: One or two braids of High Tensile Steel Wire

Cover: Abrasion-resistant Nylon Fabric

Operating Parameters

Temperature Range:

- (R604 thru R610) -50°F (-45°C) to +250°F (121°C)
(R612) -50°F (-45°C) to +212°F (100°C)
- Synthetic, synthetic blend, water, and water/oil emulsion hydraulic fluids limited to +135°F (+57°C)

Vacuum Rating: 28 inch Hg

Change in length at Max. Working Pressure: +2% to -4%

Min. Burst Pressure is 4x Max. Working Pressure at 73°F (23°C)

Fittings

HY Series

Fittings available from Parker Hose Products Division

For most Parker products, Crimp Die Selection charts can be found online at www.parker.com/crimpsource

Access instructions are on pg. G-14

Colors

- Black

Notes

*Two wire braid



WARNING

This product can expose you to chemicals including Nickel compounds, which is known to the State of California to cause cancer. For more information go to www.P65Warnings.ca.gov.

HTB – Eliminator® Hybrid® Hose



Features

- Four-spiral wire hose performance in a high tensile two-wire braid Construction
- Excellent flexibility
- Compact design

Certifications

- MSHA Accepted

Applications/Markets



- High-pressure hydraulic applications typically reserved for spiral wire reinforced hoses

[Visit the webpage](#)

Part Number	Nominal I.D.		Maximum O.D.		Maximum Working Pressure		Minimum Bend Radius		Weight		Permanent Fitting Series
	inch	mm	inch	mm	psi	MPa	inch	mm	lbs./ft.	kg./mtr.	
#											
HTB04*	1/4	6.4	.62	15.7	7,000	48.3	4.00	102	.27	.40	HY
HTB06	3/8	9.5	.76	19.3	5,500	37.9	6.00	152	.37	.55	43
HTB08	1/2	12.7	.90	22.9	5,000	34.5	7.00	178	.46	.68	43
HTB10	5/8	15.9	1.03	26.2	4,000	27.6	8.00	203	.52	.77	43
HTB12	3/4	19.1	1.20	30.5	4,000	27.6	9.50	241	.73	1.09	43
HTB16	1	25.4	1.50	38.1	3,500	24.1	12.00	305	1.01	1.50	43

Construction

Tube: Copolyester

Reinforcement: Two braids of High Tensile Steel Wire

Cover: Smooth Synthetic Rubber

Operating Parameters

Temperature Range:

- -40°F (-40°C) to +212°F (100°C)
- Synthetic, synthetic blend, water, and water/oil emulsion hydraulic fluids limited to +135°F (+57°C)

Vacuum Rating: 28 inch Hg

Change in length at Max. Working Pressure: +2% to -4%

Min. Burst Pressure is 4x Max. Working Pressure at 73°F (23°)

Fittings

HY Series 43 Series

Fittings available from Parker Hose Products Division

For most Parker products, Crimp Die Selection charts can be found online at www.parker.com/crimpsource

Access instructions are on pg. G-14

Color

- Black

Notes

*Factory-made assemblies only for size -4 with HY fittings



WARNING

This product can expose you to chemicals including Chloroprene, which is known to the State of California to cause cancer. For more information go to www.P65Warnings.ca.gov.

560TJ – TOUGHJACKET™ SAE 100R1AT Hydraulic Hose



Features

- Twin or multi-line available. Lighter and smaller than 100R1AT with longer lengths
- Fast response hose
- Polyurethane cover for best abrasion resistance

Certifications

- Meets/Exceeds SAE 100R1AT Performance
- MSHA Accepted

Applications/Markets



- Hydraulic circuits and systems wherever 100R1AT hose is specified
- Most synthetic hydraulic fluids, water and wide range of chemicals
- Excellent over-the-sheave in lift truck applications
- Industrial equipment
- Machine Tools

[Visit the webpage](#)

Part Number	Nominal I.D.		Maximum O.D.		Maximum Working Pressure		Minimum Bend Radius		Weight		Permanent Fitting Series
	inch	mm	inch	mm	psi	MPa	inch	mm	lbs./ft.	kg./mtr.	
#											
560TJ-3	3/16	4.8	0.39	9.9	3,626	25.0	0.75	19	0.01	0.11	56
560TJ-4	1/4	6.4	0.47	11.9	3,263	22.5	1.50	38	0.09	0.14	56
560TJ-5	5/16	7.9	0.53	13.4	3,118	21.5	1.75	45	0.11	0.16	56
560TJ-6	3/8	9.5	0.61	15.5	2,750	19.0	2.00	51	0.14	0.21	56
560TJ-8	1/2	12.7	0.75	19.0	2,500	17.2	3.00	76	0.19	0.29	56
560TJ-10	5/8	15.9	0.93	23.6	2,000	13.8	4.00	102	0.31	0.47	56
560TJ-12	3/4	19.1	1.04	26.4	1,750	12.1	4.25	108	0.28	0.42	56

Construction

Tube: Copolyester

Reinforcement: High Tensile Steel Wire Braid

Cover: Polyurethane TOUGHJACKET™

Operating Parameters

Temperature Range:

- Petroleum base hydraulic fluids and lubricating oils within a temperature range -40°F (-40°C) to +250°F (121°C)
- Synthetic, synthetic blend, water, and water/oil emulsion hydraulic fluids limited to +185°F (+85°C)
- Water/glycol hydraulic fluids limited to +135°F (+57°C)

Vacuum Rating: 28 inch Hg

Change in length at Max. Working Pressure: +/-2%

Min. Burst Pressure is 4x Max. Working Pressure at 73°F (23°C)

Fittings

56 Series – pg. E-13

For most Parker products, Crimp Die Selection charts can be found online at www.parker.com/crimpsource

Access instructions are on pg. G-14

Colors

- Black

Notes

Non-perforated cover



[READ THE BLOG](#)



WARNING

This product can expose you to chemicals including Nickel Compounds which is known to the State of California to cause cancer and Toluene, which is known to the State of California to cause birth defects or other reproductive harm. For more information go to www.P65Warnings.ca.gov

563TJ – TOUGHJACKET™ SAE 100R17 Hydraulic Hose

3,000 psi Constant Working Pressure



Features

- Low length change under pressure makes it an ideal solution for boom or cable track applications where long lengths are required
- 2%-5% smaller O.D. than comparable 100R17 hoses
- 23%-42% lighter than comparable 100R17 hose
- Excellent flexibility
- Consistent long-lengths

Certifications

- Meets/Exceeds SAE 100R17 Performance
- MSHA Accepted

Applications/Markets



- Medium pressure hydraulic applications
- Excellent over-the-sheave in lift truck applications
- Agricultural Equipment
- Construction Equipment
- Lubricating Oils
- Transportation

[Visit the webpage](#)

Part Number	Nominal I.D.		Maximum O.D.		Maximum Working Pressure		Minimum Bend Radius		Weight		Permanent Fitting Series
	inch	mm	inch	mm	psi	MPa	inch	mm	lbs./ft.	kg./mtr.	
#											
563TJ-4	1/4	6.3	0.47	11.9	3,045	21.0	1.50	38	0.09	0.14	56
563TJ-6	3/8	9.5	0.64	16.3	3,045	21.0	2.00	51	0.19	0.29	56
563TJ-8	1/2	12.7	0.76	19.3	3,045	21.0	2.75	70	0.24	0.36	56

Construction

Tube: Copolyester

Reinforcement: High Tensile Steel Wire Braid

Cover: Polyurethane TOUGHJACKET™

Operating Parameters

Temperature Range:

- Petroleum base hydraulic fluids and lubricating oils within a temperature range -40°F (-40°C) to +250°F (121°C)
- Synthetic, synthetic blend, water, and water/oil emulsion hydraulic fluids limited to +185°F (+85°C)
- Water/glycol hydraulic fluids limited to +135°F (+57°C)

Vacuum Rating: 28 inch Hg

Change in length at Max. Working Pressure: +/- 1%

Min. Burst Pressure is 4x Max. Working Pressure at 73°F (23°C)

Fittings

56 Series – pg. E-13

For most Parker products, Crimp Die Selection charts can be found online at www.parker.com/crimpsource

Access instructions are on pg. G-14

Colors

- Black

Notes

Non-perforated cover



[READ THE BLOG](#)



WARNING

This product can expose you to chemicals including Nickel Compounds which is known to the State of California to cause cancer and Toluene, which is known to the State of California to cause birth defects or other reproductive harm. For more information go to www.P65Warnings.ca.gov

590TJ – TOUGHJACKET™ Hydraulic Hose



Features

- Two wire strength, one wire construction, improved bend radius results
- Twin and multi-line available
- Polyurethane cover for best abrasion resistance

Certifications

- MSHA Accepted

Applications/Markets



- Construction Equipment
- Machine Tools
- Hydrostatic Transmission
- Refuse Vehicles
- Agriculture Equipment
- Excellent over-the-sheave in lift truck applications

[Visit the webpage](#)

Part Number	Nominal I.D.		Maximum O.D.		Maximum Working Pressure		Minimum Bend Radius		Weight		Permanent Fitting Series
	inch	mm	inch	mm	psi	MPa	inch	mm	lbs./ft.	kg./mtr.	
#											
590TJ-4	1/4	6.4	0.49	12.4	5,076	35.0	1.75	45	0.13	0.20	56
590TJ-6*	3/8	9.5	0.64	16.3	4,061	28.0	2.25	57	0.19	0.29	56
590TJ-8	1/2	12.7	0.76	19.3	3,553	24.5	3.25	83	0.24	0.36	56
590TJ-12	3/4	19.1	1.08	27.4	2,500	17.2	4.72	120	0.39	0.58	43
590TJ-16	1	25.4	1.42	36.1	2,030	14.0	5.91	150	0.71	1.06	43

Construction

Tube: Copolyester

Reinforcement: Aramid Fiber, High Tensile Steel Wire Braid

Cover: Polyurethane TOUGHJACKET™

Operating Parameters

Temperature Range:

- Petroleum base hydraulic fluids and lubricating oils within a temperature range -40°F (-40°C) to +250°F (121°C)
- * Synthetic, synthetic blend, water, and water/oil emulsion hydraulic fluids limited to +185°F (+85°C)
- Water/glycol hydraulic fluids limited to +135°F (+57°C)

Vacuum Rating: 28 inch Hg

Change in length at Max. Working Pressure: +/-2%

Min. Burst Pressure is 4x Max. Working Pressure at 73°F (23°C)

Fittings

56 Series – pg. E-13 43 Series

43 Series – Available from Parker Hose Products Division

For most Parker products, Crimp Die Selection charts can be found online at www.parker.com/crimpsource

Access instructions are on pg. G-14

Colors

- Black

Notes

- Non-perforated cover
- *Two wire braid



[READ THE BLOG](#)



WARNING

This product can expose you to chemicals including Nickel Compounds which is known to the State of California to cause cancer and Toluene, which is known to the State of California to cause birth defects or other reproductive harm. For more information go to www.P65Warnings.ca.gov

594TJ – TOUGHJACKET™ SAE 100R19 Hydraulic Hose 4,000 psi Constant Working Pressure



Features

- Four-spiral wire hose performance in a high tensile two-wire braid Construction
- Excellent flexibility
- Consistent long-lengths

Certifications

- Meets/Exceeds SAE 100R19 Performance
- MSHA Accepted

Applications/Markets



- Medium pressure hydraulic applications
- Agricultural Equipment
- Construction Equipment
- Lubricating Oils
- Transportation
- Excellent over-the-sheave in lift truck applications

[Visit the webpage](#)

Part Number	Nominal I.D.		Maximum O.D.		Maximum Working Pressure		Minimum Bend Radius		Weight		Permanent Fitting Series
	inch	mm	inch	mm	psi	MPa	inch	mm	lbs./ft.	kg./mtr.	
#											
594TJ-4*	1/4	6.3	0.49	12.5	4,061	28.0	1.75	45	0.13	0.19	56
594TJ-6*	3/8	10	0.64	16.3	4,061	28.0	2.50	65	0.19	0.28	56
594TJ-8* **	1/2	13	0.85	21.5	4,061	28.0	3.50	90	0.39	0.59	43
594TJ-10**	5/8	16	1.04	26.4	4,061	28.0	3.94	100	0.59	0.88	43

Construction

Tube: Copolyester

Reinforcement: One or two Braids of High Tensile Steel Wire

Cover: Polyurethane TOUGHJACKET™

Operating Parameters

Temperature Range:

- Petroleum base hydraulic fluids and lubricating oils within a temperature range -40°F (-40°C) to +212°F (100°C)
- * Synthetic, synthetic blend, water, and water/oil emulsion hydraulic fluids limited to +185°F (+85°C)
- Water/glycol hydraulic fluids limited to +135°F (+57°C)

Vacuum Rating: 28 inch Hg

Change in length at Max. Working Pressure: +/-2%

Min. Burst Pressure is 4x Max. Working Pressure at 73°F (23°C)

Fittings

56 Series – pg. E-13 43 Series

43 Series – Available from Parker Hose Products Division

For most Parker products, Crimp Die Selection charts can be found online at www.parker.com/crimpsource

Access instructions are on pg. G-14

Colors

- Black

Notes

Non-perforated cover

**Two wire braid



[READ THE BLOG](#)



WARNING

This product can expose you to chemicals including Nickel Compounds which is known to the State of California to cause cancer and Toluene, which is known to the State of California to cause birth defects or other reproductive harm. For more information go to www.P65Warnings.ca.gov

510A – Refrigerant Hose



Features

- Compatible with most common hydraulic and refrigeration media

Certifications

- Meets/Exceeds SAE 100R7
- MSHA Accepted except -4

Applications/Markets



- Industrial and mobile refrigeration systems

[Visit the webpage](#)

Part Number	Nominal I.D.		Maximum O.D.		Maximum Working Pressure		Minimum Bend Radius		Weight		Permanent Fitting Series	Field Attachable Series
	inch	mm	inch	mm	psi	MPa	inch	mm	lbs./ft.	kg./mtr.		
#												
510A-3	3/16	4.8	.43	10.9	3,000	20.7	2.00	51	.05	.07	56	51
510A-4	1/4	6.4	.47	11.9	2,750	19.0	2.50	64	.05	.08	56	51

Construction

Tube: Proprietary Nylon Blend

Reinforcement: Fiber

Cover: Polyurethane

Operating Parameters

Temperature Range:

- 40°F (-40°C) to +212°F (100°C)

Vacuum Rating: 28 inch Hg

Change in length at Max. Working Pressure: +/-3%

Min. Burst Pressure is 4x Max. Working Pressure at 73°F (23°C)

Fittings

56 Series – pg. E-13 51 Series – pg. E-8

For most Parker products, Crimp Die Selection charts can be found online at www.parker.com/crimpsource

Access instructions are on pg. G-14

Colors

- Black

Notes

- Perforated cover
- 51 Series field attachable couplings are not intended for use on hose that has previously been in service



WARNING

This product can expose you to chemicals including Nickel Compounds which is known to the State of California to cause cancer and Toluene, which is known to the State of California to cause birth defects or other reproductive harm. For more information go to www.P65Warnings.ca.gov

510C – General Hydraulic Hose



Features

- Excellent abrasion resistance
- Excellent flexibility
- Low coefficient of friction cover
- Medium pressure service for permanent and field attachable fittings

Certifications

- Meets/Exceeds SAE 100R7 except -2
- MSHA Accepted except -4

Applications/Markets



- Industrial hydraulic systems
- Mobile hydraulic systems
- On-highway hydraulics systems (car carriers & trailers)



[READ THE BLOG](#)

[Visit the webpage](#)

Part Number	Nominal I.D.		Maximum O.D.		Maximum Working Pressure		Minimum Bend Radius		Weight		Permanent Fitting Series	Field Attachable Series
	inch	mm	inch	mm	psi	MPa	inch	mm	lbs./ft.	kg./mtr.		
#												
510C-2	1/8	3.2	.34	8.6	2,500	17.2	0.50	13	.03	.05	56	-
510C-3	3/16	4.8	.43	10.9	3,250	22.4	0.75	19	.05	.07	56	51*
510C-4	1/4	6.4	.47	11.9	3,000	20.7	1.50	38	.05	.08	56	51*
510C-5	5/16	7.9	.57	14.5	2,500	17.2	1.75	45	.08	.11	56	51
510C-6	3/8	9.5	.64	16.3	2,250	15.5	2.00	51	.10	.14	56	51
510C-8	1/2	12.7	.81	20.6	2,250	15.5	3.00	76	.15	.22	56	51
510C-12	3/4	19.1	1.09	27.7	1,250	8.7	5.00	127	.21	.31	56	51
510C-16	1	25.4	1.32	33.5	1,000	6.9	8.00	203	.27	.40	56	51

Construction

Tube: Copolyester
 Reinforcement: Fiber
 Cover: Polyurethane

Operating Parameters

Temperature Range:

- 40°F (-40°C) to +212°F (100°C)
- Synthetic, synthetic blend, water, and water/oil emulsion hydraulic fluids limited to +135°F (+57°C)

Vacuum Rating: 28 inch Hg

Change in length at Max. Working Pressure: +/-2%

Min. Burst Pressure is 4x Max. Working Pressure at 73°F (23°C)

Fittings

56 Series – pg. E-13 51 Series – pg. E-8

For most Parker products, Crimp Die Selection charts can be found online at www.parker.com/crimpsource

Access instructions are on pg. G-14

Colors

- Black

Notes

- Perforated cover
- *3/16" and 1/4" working pressure reduced to 3,000 and 2,750 psi respectively when using field attachable couplings
- 51 Series field attachable couplings are not intended for use on hose that has previously been in service



WARNING

This product can expose you to chemicals including Nickel Compounds which is known to the State of California to cause cancer and Toluene, which is known to the State of California to cause birth defects or other reproductive harm. For more information go to www.P65Warnings.ca.gov

518C – Non-Conductive Hose



Features

- Twin or multi-line constructions available
- High density braid for maximum impulse life without loss of flexibility
- Low coefficient of friction cover

Certifications

- Meets SAE J517 for less than 50 micro-amps leakage under 75,000 volts per ft.
- Meets/Exceeds SAE 100R7 specifications and Electrical Standards except 518C-2 with respect to maximum working pressure
- ANSI A92.2

Applications/Markets



- Medium pressure hydraulic service where hydraulic circuit exposure and contact with high voltage may be encountered
- Aerial lift equipment
- Hydraulic tools where exposure to high voltage may be encountered

[Visit the webpage](#)

Part Number	Nominal I.D.		Maximum O.D.		ANSI A92.2 Max. Working Pressure		SAE 100R7 Max. Working Pressure		Minimum Bend Radius		Weight		Permanent Fitting Series	Field Attachable Series
	inch	mm	inch	mm	psi	MPa	psi	MPa	inch	mm	lbs./ft.	kg./mtr.		
#														
518C-2	1/8	3.2	.34	8.6	3,150	21.7	2,500	17.2	0.50	13	.03	.05	56	-
518C-3	3/16	4.8	.43	10.9	3,250	22.4	3,250	22.4	0.75	19	.05	.07	56	51*
518C-4	1/4	6.4	.47	11.9	3,150	21.7	3,000	21.0	1.50	38	.05	.08	56	51*
518C-5	5/16	7.9	.57	14.5	3,150	21.7	2,500	17.2	1.75	45	.08	.11	56	51
518C-6	3/8	9.5	.64	16.3	3,000	20.7	2,250	15.5	2.00	51	.10	.14	56	51
518C-8	1/2	12.7	.81	20.6	3,000	20.7	2,250	15.5	3.00	76	.15	.22	56	51
518C-12	3/4	19.1	1.09	27.7	1,660	11.4	1,250	8.7	5.00	127	.21	.31	56	51
518C-16	1	25.4	1.32	33.5	1,330	9.2	1,000	6.9	8.00	203	.27	.40	56	51

Construction

Tube: Copolyester
Reinforcement: Fiber
Cover: Polyurethane

Fittings

56 Series – pg. E-13 51 Series– pg. E-8

For most Parker products, Crimp Die Selection charts can be found online at www.parker.com/crimpsource
Access instructions are on pg. G-14

Operating Parameters

Temperature Range:

- -40°F (-40°C) to +212°F (100°C)
- Synthetic, synthetic blend, water, and water/oil emulsion hydraulic fluids limited to +135°F (+57°C)

Vacuum Rating: 28 inch Hg

Change in length at Max. Working Pressure: +/-2%

Min. Burst Pressure: (SAE requires 4:1 Design Factor)

- 4:1 Design Factor is required if hose failure will result in movement of aerial device
- 3:1 Design Factor is acceptable if hose failure will not result in movement of aerial device

Colors

- Orange

Notes

- Non-perforated cover
- Lay lines on this hose will have both ANSI and SAE maximum working pressure listed. ANSI A92.2 "Vehicle Mounted Elevating and Rotating Aerial Devices"
- *3/16" and 1/4" working pressure reduced to 3,000 and 2,750 psi respectively when using field attachable couplings
- 51 Series field attachable couplings are not intended for use on hose that has previously been in service



WARNING

This product can expose you to chemicals including Nickel Compounds which is known to the State of California to cause cancer and Toluene, which is known to the State of California to cause birth defects or other reproductive harm. For more information go to www.P65Warnings.ca.gov

518D – Non-Conductive Hose



Features

- Nylon core for maximum resistance to permeable fluids.
- 518D-4 offers heavier polyurethane jacket improving abrasion resistance and ease of splitting bonded constructions
- Super high density braid allows smaller braid O.D. (518D-4)
- Low coefficient of friction cover
- Twin or multi-line constructions available.

Applications/Markets



- Medium pressure hydraulic service where hydraulic circuit exposure and contact with high voltage may be encountered
- Aerial lift equipment
- Hydraulic tools where exposure to high voltage may be encountered

Certifications

- Meets SAE J517 for less than 50 micro-amps leakage under 75,000 volts per ft.
- Meets/Exceeds SAE 100R7
- ANSI A92.2

[Visit the webpage](#)

Part Number	Nominal I.D.		Maximum O.D.		ANSI A92.2 Max. Working Pressure 73°F/ 23°C		SAE 100R7 Max. Working Pressure 73°F/ 23°C		Minimum Bend Radius		Weight		Permanent Fitting Series
	#	inch	mm	inch	mm	psi	MPa	psi	MPa	inch	mm	lbs./ft.	
518D-2	1/8	3.2	.34	8.6	3,150	21.7	3,000	21.0	0.50	13	.03	.05	56
518D-3	3/16	4.8	.43	10.9	3,250	22.4	3,250	22.4	0.75	19	.05	.07	56
518D-4	1/4	6.4	.47	11.9	3,150	21.7	3,000	20.7	1.50	38	.06	.09	56
518D-5	5/16	7.9	.57	14.5	3,150	21.7	2,500	17.2	1.75	45	.08	.11	56
518D-6	3/8	9.5	.64	16.3	3,000	20.7	2,250	15.5	2.00	51	.10	.14	56
518D-8	1/2	12.7	.81	20.6	3,000	20.7	2,250	15.5	3.00	76	.15	.22	56
518D-12	3/4	19.1	1.09	27.7	1,660	11.4	1,250	8.7	5.00	127	.21	.31	56

Construction

Tube: Nylon
 Reinforcement: Fiber
 Cover: Polyurethane

Operating Parameters

Temperature Range:
 • -40°F (-40°C) to +212°F (100°C)
 Vacuum Rating: 28 inch Hg
 Change in length at Max. Working Pressure: +/-2%
 Min. Burst Pressure: (SAE requires 4:1 Design Factor)
 • 4:1 Design Factor is required if hose failure will result in movement of aerial device
 • 3:1 Design Factor is acceptable if hose failure will not result in movement of aerial device

Fittings

56 Series – pg. E-13

For most Parker products, Crimp Die Selection charts can be found online at www.parker.com/crimpsource

Access instructions are on pg. G-14

Colors

- Orange

Notes

- Non-perforated cover
- Lay lines on this hose will have both ANSI and SAE maximum working pressure listed. ANSI A92.2 “Vehicle Mounted Elevating and Rotating Aerial Devices”



WARNING

This product can expose you to chemicals including Nickel Compounds which is known to the State of California to cause cancer and Toluene, which is known to the State of California to cause birth defects or other reproductive harm. For more information go to www.P65Warnings.ca.gov

515H – Compact/Light Weight Hose



Features

- Twin or multi-line available
- Compact O.D., light weight, flexible
- Uses rapid assembly (quick connect) Fittings

Certifications

- MSHA Accepted

Applications/Markets



- Hydraulic and pneumatic systems where a small O.D. hose is necessary
- Pilot Lines
- Joystick Controls

[Visit the webpage](#)

Part Number	Nominal I.D.		Maximum O.D.		Maximum Working Pressure		Minimum Bend Radius		Weight		Permanent Fitting Series
	inch	mm	inch	mm	psi	MPa	inch	mm	lbs./ft.	kg./mtr.	
#											
515H-4	1/4	6.4	.41	10.4	2,000	13.8	1.50	38	.04	.05	54
515H-6	3/8	9.5	.56	14.2	1,500	10.3	2.00	51	.05	.08	54

Construction

Tube: Copolyester
Reinforcement: Fiber
Cover: Polyurethane

Operating Parameters

Temperature Range:

- -40°F (-40°C) to +212°F (100°C)
- Synthetic, synthetic blend, water, and water/oil emulsion hydraulic fluids limited to +135°F (+57°C)

Vacuum Rating: 28 inch Hg

Change in length at Max. Working Pressure: +/-2%

Min. Burst Pressure is 4x Max. Working Pressure at 73°F (23°C)

Fittings

54 Series – pg. E-10

For most Parker products, Crimp Die Selection charts can be found online at www.parker.com/crimpsource

Access instructions are on pg. G-14

Colors

- Black

Notes

- Approved with rapid assembly fitting system
- Perforated cover



[READ THE BLOG](#)



WARNING

This product can expose you to chemicals including Nickel Compounds which is known to the State of California to cause cancer and Toluene, which is known to the State of California to cause birth defects or other reproductive harm. For more information go to www.P65Warnings.ca.gov

520N/528N – General Hydraulic Hose



Features

- Twin and multi-line available
- Fast response, lighter and smaller O.D. than 100R2 hose

Certifications

- Meets/Exceeds SAE 100R8
- 520N MSHA Accepted
- 528N Meets SAE J517 for less than 50 micro-amps leakage under 75,000 volts per foot

Applications/Markets



- Hydraulic and pneumatic circuits and systems
- Hydraulic tool applications
- Ideal in hot water applications

[Visit the webpage](#)

Part Number		Nominal I.D.		Maximum O.D.		Maximum Working Pressure		Minimum Bend Radius		Weight		Permanent Fitting Series
#	#	⊙		⊙		↗		↘		lbs	kg	⊕
Natural	Non-Conductive	inch	mm	inch	mm	psi	MPa	inch	mm	lbs./ft.	kg./mtr.	
520N-3	528N-3	3/16	4.8	.43	10.9	5,000	34.5	1.50	38	.05	.07	56
520N-4	528N-4	1/4	6.4	.51	13.0	5,000	34.5	2.00	51	.07	.10	56
520N-5	528N-5	5/16	7.9	.57	14.5	4,500	31.0	2.50	64	.08	.12	56
520N-6	528N-6	3/8	9.5	.65	16.5	4,000	27.6	2.50	64	.08	.13	56
520N-8	528N-8	1/2	12.7	.81	20.6	3,500	24.1	4.00	102	.14	.20	56

Construction

Tube: Nylon
 Reinforcement: Aramid Fiber
 Cover: Polyurethane

Operating Parameters

Temperature Range:
 • -40°F (-40°C) to +212°F (100°C)
 Vacuum Rating: 28 inch Hg
 Change in length at Max. Working Pressure: +/-2%
 Min. Burst Pressure is 4x Max. Working Pressure at 73°F (23°C)

Fittings

56 Series – pg. E-13
 For most Parker products, Crimp Die Selection charts can be found online at www.parker.com/crimpsource
 Access instructions are on pg. G-14

Colors

- Black
- Orange (Non-Conductive)

Notes

- Perforated cover - 520N
- Non-perforated cover - 528N



[READ THE BLOG](#)



WARNING

This product can expose you to chemicals including Nickel Compounds which is known to the State of California to cause cancer and Toluene, which is known to the State of California to cause birth defects or other reproductive harm. For more information go to www.P65Warnings.ca.gov

527BA – Breathing Air Refill Hose



Features

- 7000 psi constant pressure

Certifications (Complies with:)

- CGA G7.1-1 Grade E Breathing Air Standards
- NFPA 1901

Applications/Markets



- Integrated containment fill stations
- Mobile and stationary systems with or without cascade controls



- Mobile Trailer/Truck Systems
- Portable SCBA Fill

[Visit the webpage](#)

Part Number	Nominal I.D.		Maximum O.D.		Maximum Working Pressure		Minimum Bend Radius		Weight		Permanent Fitting Series
	inch	mm	inch	mm	psi	MPa	inch	mm	lbs./ft.	kg./mtr.	
#											
527BA-3	3/16	4.8	.43	10.9	7,000	48.3	1.50	38	.05	.07	CG
527BA-4	1/4	6.4	.52	13.2	7,000	48.3	2.00	51	.07	.11	CG

Construction

Tube: Nylon

Reinforcement: Aramid Fiber

Cover: Polyurethane

Operating Parameters

Temperature Range:

- -40°F (-40°C) to +180°F (82°C)

Vacuum Rating: 28 inch Hg

Change in length at Max. Working Pressure: +/-2%

Min. Burst Pressure is 4x Max. Working Pressure at 73°F (23°C)

Fittings

CG Series – pg. E-56

Steel and Stainless Steel connection configurations limited to:

101CG-2-4 101CG-4-4 102CG-2-4 102CG-4-4
 103CG-4-4 13ECG-4-4 106CG-4-4 137CG-4-4
 139CG-4-4 141CG-4-4 1L9CG-4-4

For most Parker products, Crimp Die Selection charts can be found online at www.parker.com/crimpsource

Access instructions are on pg. G-14



WARNING

This product can expose you to chemicals including Nickel Compounds which is known to the State of California to cause cancer and Toluene, which is known to the State of California to cause birth defects or other reproductive harm. For more information go to www.P65Warnings.ca.gov

Colors

- Blue

Notes

- Perforated cover
- Not for use as part of a SCBA systems
- This hose is not for use between a pressure reducing regulator and breathing mask
- For fitting attachment lubricate only with water or non-toxic lubricant. Do not assemble with petroleum or hydrocarbon based lubricants. Do not flush with solvents of any kind
- This hose does not contain a conductive element; therefore, it should not be used with explosive gases such as pure oxygen and hydrogen
- Hose is compliant with CGA Grade E Breathing Air Standards, however air quality is dependent upon all system components

53DM/538DM – DuraMax™ Low Temperature



Features

- Low coefficient of friction cover
- Superior flexibility in cold temperature applications
- Better bend radius than SAE J517 and 100R7
- Smaller O.D. than 100R7 and 100R18
- 3000 psi constant pressure

Certifications

- Meets/Exceeds SAE 100R18
- 538DM Meets SAE J517 for less than 50 micro-amps leakage under 75,000 volts per foot

Applications/Markets

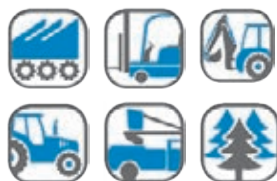

- Excellent over-the-sheave in lift truck applications
- Cold storage or refrigerated areas
- Construction and agriculture equipment in cold climates

[Visit the webpage](#)

Part Number		Nominal I.D.		Maximum O.D.		Maximum Working Pressure		Minimum Bend Radius		Weight		Permanent Fitting Series
#	#											
Natural	Non-Conductive	inch	mm	inch	mm	psi	MPa	inch	mm	lbs./ft.	kg./mtr.	
53DM-4	-	1/4	6.4	.49	12.4	3,000	20.7	1.25	32	.07	.10	56
53DM-6	538DM-6	3/8	9.5	.66	16.8	3,000	20.7	2.00	51	.11	.16	56
53DM-8	-	1/2	12.7	.84	21.3	3,000	20.7	3.50	89	.17	.26	56
53DM-10	-	5/8	15.9	1.03	26.2	3,000	20.7	4.00	102	.22	.33	56
53DM-12	-	3/4	19.1	1.13	28.7	3,000	20.7	6.50	165	.26	.39	CG

Construction

Tube: Copolyester
 Reinforcement: Fiber
 Cover: Copolyester

Operating Parameters

Temperature Range:

- -70°F (-57°C) to +212°F (100°C)
- Water/glycol hydraulic fluids limited to +135°F (+57°C)

Vacuum Rating: 28 inch Hg

Change in length at Max. Working Pressure: +/-2%

Min. Burst Pressure is 4x Max. Working Pressure at 73°F (23°C)

Fittings

56 Series – pg. E-13 CG Series – pg. E-56

For most Parker products, Crimp Die Selection charts can be found online at www.parker.com/crimpsource

Access instructions are on pg. G-14

Colors

- Black
- Orange (Non-Conductive)

Notes

- Perforated cover - 53DM
- Non-perforated cover - 538DM



[READ THE BLOG](#)



WARNING

This product can expose you to chemicals including Nickel compounds, which is known to the State of California to cause cancer. For more information go to www.P65Warnings.ca.gov.

540N – General Hydraulic Hose



Features

- Matte cover for low coefficient of friction
- Special order Colors
- Twin or multi-line available
- Good chemical compatibility

Certifications

- Meets/Exceeds SAE 100R7
- MSHA Accepted

Applications/Markets



- Hydraulic and pneumatic systems
- Agricultural Spraying
- Polyurethane Foam Mixers
- Hot Water

[Visit the webpage](#)

Part Number	Nominal I.D.		Maximum O.D.		Maximum Working Pressure		Minimum Bend Radius		Weight		Permanent Fitting Series
	inch	mm	inch	mm	psi	MPa	inch	mm	lbs./ft.	kg./mtr.	
#											
540N-2	1/8	3.2	.34	8.6	3,000	20.7	0.50	13	.03	.05	56
540N-3	3/16	4.8	.44	11.2	3,000	20.7	0.75	19	.04	.06	56
540N-4	1/4	6.4	.50	12.7	2,750	19.0	1.50	38	.07	.10	56
540N-5	5/16	7.9	.58	14.7	2,500	17.2	1.75	45	.07	.10	56
540N-6	3/8	9.5	.65	16.5	2,250	15.5	2.00	51	.09	.13	56
540N-8	1/2	12.7	.81	20.6	2,000	13.8	3.00	76	.13	.19	56
540N-12	3/4	19.4	1.05	26.7	1,250	8.6	6.00	152	.17	.25	56

Construction

Tube: Nylon
Reinforcement: Fiber
Cover: Polyurethane

Operating Parameters

Temperature Range:

- -40°F (-40°C) to +212°F (100°C)

 Vacuum Rating: 28 inch Hg
 Change in length at Max. Working Pressure: +/-2%
 Min. Burst Pressure is 4x Max. Working Pressure at 73°F (23°C)

Fittings

56 Series – pg. E-13
 For most Parker products, Crimp Die Selection charts can be found online at www.parker.com/crimpsource
 Access instructions are on pg. G-14

Colors

- Black

Notes

Perforated cover



WARNING

This product can expose you to chemicals including Nickel Compounds which is known to the State of California to cause cancer and Toluene, which is known to the State of California to cause birth defects or other reproductive harm. For more information go to www.P65Warnings.ca.gov

540P – Specialty Water Hose



Features

- Plasticizer free non-leaching core tube
- Low-moisture permeability

Certifications

- Meets/Exceeds SAE 100R7
- Core tube compliant with FDA Title 21

Applications/Markets



- Potable water delivery to remote sites
- Distilled and de-ionized water
- Polyurethane Foam Mixers
- Inert gas transfer

[Visit the webpage](#)

Part Number	Nominal I.D.		Maximum O.D.		Maximum Working Pressure		Minimum Bend Radius		Weight		Permanent Fitting Series
	inch	mm	inch	mm	psi	MPa	inch	mm	lbs./ft.	kg./mtr.	
#											
540P-4	1/4	6.4	.50	12.7	2,750	19.0	1.25	32	.05	.08	56
540P-6	3/8	9.5	.65	16.5	2,250	15.5	2.00	51	.09	.13	56
540P-8	1/2	12.7	.81	20.6	2,000	13.8	3.00	76	.13	.19	56

Construction

Tube: Polyethylene
Reinforcement: Fiber
Cover: Polyurethane

Operating Parameters

Temperature Range:
 • -40°F (-40°C) to +150°F (66°C)
 Vacuum Rating: 28 inch Hg
 Change in length at Max. Working Pressure: +/-2%
 Min. Burst Pressure is 4x Max. Working Pressure at 73°F (23°C)

Fittings

56 Series – pg. E-13
 For most Parker products, Crimp Die Selection charts can be found online at www.parker.com/crimpsource
 Access instructions are on pg. G-14

Colors

- Aqua

Notes

Perforated cover



WARNING

This product can expose you to chemicals including Nickel Compounds which is known to the State of California to cause cancer and Toluene, which is known to the State of California to cause birth defects or other reproductive harm. For more information go to www.P65Warnings.ca.gov

55LT – Low Temperature Hose



Features

- Twin and multi-line available
- Superior flexibility in cold temperature applications

Certifications

- Meets/Exceeds SAE 100R7

Applications/Markets



- Hydraulic systems exposed to very low temperatures
- Excellent over-the-sheave in lift truck applications
- Cold storage or refrigerated areas
- Construction and agriculture equipment in cold climates

[Visit the webpage](#)

Part Number	Nominal I.D.		Maximum O.D.		Maximum Working Pressure		Minimum Bend Radius		Weight		Permanent Fitting Series
	inch	mm	inch	mm	psi	MPa	inch	mm	lbs./ft.	kg./mtr.	
#											
55LT-2	1/8	3.2	.34	8.6	3,000	20.7	0.50	13	.03	.05	56
55LT-3	3/16	4.8	.43	10.9	3,250	22.4	0.75	19	.05	.08	56
55LT-4	1/4	6.4	.51	13.0	3,000	20.7	1.25	32	.07	.10	56
55LT-5	5/16	7.9	.57	14.5	2,500	17.2	1.75	45	.09	.13	56
55LT-6	3/8	9.5	.66	16.8	2,250	15.5	2.00	51	.10	.14	56
55LT-8	1/2	12.7	.81	20.6	2,000	13.8	3.00	76	.14	.21	56

Construction

Tube: Copolyester
 Reinforcement: Fiber
 Cover: Copolyester

Operating Parameters

Temperature Range:

- -70°F (-57°C) to +212°F (100°C)
- Water/glycol hydraulic fluids limited to +135°F (+57°C)

Vacuum Rating: 28 inch Hg
 Change in length at Max. Working Pressure: +/-2%
 Min. Burst Pressure is 4x Max. Working Pressure at 73°F (23°C)

Fittings

56 Series – pg. E-13

For most Parker products, Crimp Die Selection charts can be found online at www.parker.com/crimpsource

Access instructions are on pg. G-14

Colors

- Black

Notes

Perforated cover



[READ THE BLOG](#)



WARNING

This product can expose you to chemicals including Nickel compounds, which is known to the State of California to cause cancer. For more information go to www.P65Warnings.ca.gov.

56DH – Diagnostic Hose



Features

- Twin or multi-line available
- Compact O.D.
- Light weight
- Flexible

Certifications

- MSHA Accepted for -2 only

Applications/Markets



- Hydraulic and pneumatic systems where a small O.D. hose is necessary
- Diagnostic hydraulic lines

[Visit the webpage](#)

Part Number	Nominal I.D.		Maximum O.D.		Maximum Working Pressure		Minimum Bend Radius		Weight		Permanent Fitting Series
	inch	mm	inch	mm	psi	MPa	inch	mm	lbs./ft.	kg./mtr.	
#											
Natural	inch	mm	inch	mm	psi	MPa	inch	mm	lbs./ft.	kg./mtr.	
56DH-1.5	.09	2.3	.20	5.1	6,000	41.4	0.25	6	.02	.01	SF
56DH-2	.14	3.6	.32	8.1	6,000	41.4	0.50	13	.03	.05	CY

Construction

Tube: Nylon
 Reinforcement: Aramid Fiber
 Cover: Polyurethane

Operating Parameters

Temperature Range:
 • -40°F (-40°C) to +200°F (93°C)
 Vacuum Rating: 28 inch Hg
 Change in length at Max. Working Pressure: +/-2%
 Min. Burst Pressure is 4x Max. Working Pressure at 73°F (23°C)

Fittings

CY Series - pg. E-62 SF Series - pg. E-67
 For most Parker products, Crimp Die Selection charts can be found online at www.parker.com/crimpsource
 Access instructions are on pg. G-14

Colors

- Black

Notes

- Perforated cover



WARNING

This product can expose you to chemicals including Nickel Compounds which is known to the State of California to cause cancer and Toluene, which is known to the State of California to cause birth defects or other reproductive harm. For more information go to www.P65Warnings.ca.gov

575X/575XN – Fast Response Hose



Features

- Light weight
- Low change in length under pressure
- Low volumetric expansion
- Fast response even over longer lengths
- 5000 psi constant pressure

Certifications

- MSHA Accepted for 575X only

Applications/Markets



- Marine, offshore drilling
- Applications requiring fast and accurate response time

[Visit the webpage](#)

Part Number	Nominal I.D.		Maximum O.D.		Maximum Working Pressure		Minimum Bend Radius		Weight		Permanent Fitting Series
	inch	mm	inch	mm	psi	MPa	inch	mm	lbs./ft.	kg./mtr.	
#											
575X-3	3/16	4.8	.43	10.9	5,000	34.5	1.50	38	.05	.07	CG
575X-4	1/4	6.4	.51	13.0	5,000	34.5	2.00	51	.07	.10	CG
575X-6	3/8	9.5	.64	16.3	5,000	34.5	3.00	76	.09	.13	CG
575XN-8	1/2	12.7	.81	20.6	5,000	34.5	4.00	102	.14	.21	CG
575X-12	3/4	19.1	1.15	29.2	5,000	34.5	8.00	203	.24	.36	CG
575X-16	1	25.4	1.59	40.4	5,000	34.5	10.00	254	.48	.70	CG

Construction

Tube: Nylon

Reinforcement: Fiber

Cover: Polyurethane; 575XN -8 Nylon

Operating Parameters

Temperature Range:

- -40°F (-40°C) to +212°F (100°C)

Vacuum Rating: 28 inch Hg

Change in length at Max. Working Pressure: +/-2%

Min. Burst Pressure is 4x Max. Working Pressure at 73°F (23°C)

Fittings

CG Series - pg. E-56

For most Parker products, Crimp Die Selection charts can be found online at www.parker.com/crimpsource

Access instructions are on pg. G-14

Colors

- Black

Notes

Non-perforated cover



WARNING

This product can expose you to chemicals including Nickel Compounds which is known to the State of California to cause cancer and Toluene, which is known to the State of California to cause birth defects or other reproductive harm. For more information go to www.P65Warnings.ca.gov

580N/H580N/588N – High Pressure Hose



Features

- Twin and multi-line available
- Lighter weight and smaller O.D. than 100R2

Certifications

- Meets/Exceeds SAE 100R8
- 580N MSHA Approved
- 588N Meets SAE J517 for less than 50 micro-amps leakage under 75,000 volts per foot

Applications/Markets



- Hydraulic and pneumatic circuits and systems

[Visit the webpage](#)

Part Number		Nominal I.D.		Maximum O.D.		Maximum Working Pressure		Minimum Bend Radius		Weight		Permanent Fitting Series
#	#											
Natural	Non-Conductive	inch	mm	inch	mm	psi	MPa	inch	mm	lbs./ft.	kg./mtr.	
580N-8	588N-8*	1/2	12.7	.89	22.6	3,500	24.1	4.00	102	.21	.31	56
580N-10	588N-10*	5/8	15.9	.98	24.9	2,750	19.0	6.00	152	.21	.31	56
580N-12	588N-12*	3/4	19.1	1.15	29.2	2,250	15.5	8.00	203	.23	.35	56
580N-16	588N-16*	1	25.4	1.47	37.3	2,000	13.8	10.00	254	.38	.56	56
H580N-16*	-	1	25.4	1.58	40.1	3,000	20.7	10.00	254	.53	.79	CG

Construction

Tube: Nylon
Reinforcement: Fiber
Cover: Polyurethane

Operating Parameters

Temperature Range:
 • -40°F (-40°C) to +212°F (100°C)
 Vacuum Rating: 28 inch Hg
 Change in length at Max. Working Pressure: +/-2%
 Min. Burst Pressure is 4x Max. Working Pressure at 73°F (23°C)

Fittings

56 Series – pg. E-13 *CG Series – pg. E-56
 For most Parker products, Crimp Die Selection charts can be found online at www.parker.com/crimpsource
 Access instructions are on pg. G-14

Colors

- Black
- Orange (Non-Conductive)

Notes

- Perforated cover - 580N
- *Non-perforated cover -588N, H580N-16



WARNING

This product can expose you to chemicals including Nickel Compounds which is known to the State of California to cause cancer and Toluene, which is known to the State of California to cause birth defects or other reproductive harm. For more information go to www.P65Warnings.ca.gov

83FR – DuraGard™ General Purpose Polyurethane



Features

- Weld spatter resistant
- Excellent abrasion resistance
- Excellent flexibility
- Compact bend radius
- Specially Formulated Polyurethane tube
- Twin-line or multi-line constructions available

Certifications

- MSHA Accepted
- Non-conductive per SAE J343 test procedures for thermoplastic hose
- UL94HB compliant

Applications/Markets



- General purpose air and water hose often used in robotic welding applications

[Visit the webpage](#)

Part Number	Nominal I.D.		Maximum O.D.		Maximum Working Pressure		Minimum Bend Radius		Weight		Permanent Fitting Series	Push-Lok Fitting*
	inch	mm	inch	mm	psi	MPa	inch	mm	lbs./ft.	kg./mtr.		
#												
83FR-4	1/4	6.4	.48	12.2	300	2.1	1.00	25	.05	.07	56	82*
83FR-6	3/8	9.5	.60	15.2	300	2.1	2.00	51	.08	.11	56	82*
83FR-8	1/2	12.7	.76	19.3	300	2.1	2.50	64	.12	.17	56	82*
83FR-12	3/4	19.1	1.04	26.4	300	2.1	3.50	89	.19	.28	56	82*

Construction

Tube: Specially Formulated Polyurethane
 Reinforcement: Fiber
 Cover: Polyurethane

Colors

- Black (BLK)
- Blue (BLU)
- Brown (BRN)
- Green (GRN)
- Gray (GRA)
- Red (RED)

Operating Parameters

Temperature Range:

- -20°F (-29°C) to +200°F (93°C)

 Change in length at Max. Working Pressure: +/-2%
 Min. Burst Pressure is 4x Max. Working Pressure at 73°F (23°C)

Notes

- *Temperature and pressure reduced with 82 series Push-Lok Fitting:
 -20°F (-29°C) to +145°F (+63°C)
 175 psi maximum working pressure
- Non-perforated cover

Fittings

56 Series – pg. E-13
 82 Series – Available from Parker Hose Products Division

For most Parker products, Crimp Die Selection charts can be found online at www.parker.com/crimpsource
 Access instructions are on pg. G-14



WARNING

This product can expose you to chemicals including Antimony Oxide (Antimony Trioxide), which is known to the State of California to cause cancer. For more information go to www.P65Warnings.ca.gov.

1035HT – High Temperature Power Cleaning



Features

- Non-marring
- Broad temperature range

Applications/Markets



- Pressure Washers (low pressure)
- Carpet Cleaning

[Visit the webpage](#)

Part Number	Nominal I.D.		Maximum O.D.		Maximum Working Pressure		Minimum Bend Radius		Weight		Permanent Fitting Series
	inch	mm	inch	mm	psi	MPa	inch	mm	lbs./ft.	kg./mtr.	
1035HT-4	1/4	6.4	.50	12.7	1,750	12.1	1.50	38	.06	.08	56

Construction

Tube: Nylon

Reinforcement: Fiber

Cover: Polyurethane

Operating Parameters

Temperature Range:

- -40°F (-40°C) to +230°F (110°C)

Vacuum Rating: 28 inch Hg

Change in length at Max. Working Pressure: +/-2%

Min. Burst Pressure is 4x Max. Working Pressure at 73°F (23°C)

Fittings

56 Series – pg. E-13

For most Parker products, Crimp Die Selection charts can be found online at www.parker.com/crimpsource

Access instructions are on pg. G-14

Colors

- Yellow

Notes

- Perforated cover
- No chlorinated solvents should be used
- Also available with a blue jacket (1035HT-4-BLU) upon request
- HBR (Hose Bend Restrictor) suggested for carpet cleaning applications - See Hose Guard in Tooling Equipment and Accessories Section pg. F-18



WARNING

This product can expose you to chemicals including Nickel Compounds which is known to the State of California to cause cancer and Toluene, which is known to the State of California to cause birth defects or other reproductive harm. For more information go to www.P65Warnings.ca.gov

B9 - General Purpose Transfer Hose



Features

- Excellent flexibility
- Light Weight
- Specially Formulated Polyurethane core tube for good chemical compatibility

Applications/Markets



- Low pressure transmission of air, oil, water, and coolants

[Visit the webpage](#)

Part Number	Nominal I.D.		Maximum O.D.		Maximum Working Pressure		Minimum Bend Radius		Weight		Permanent Fitting Series	Field Attachable Series
	inch	mm	inch	mm	psi	MPa	inch	mm	lbs./ft.	kg./mtr.		
#												
B903	3/16	4.8	.39	9.9	250	1.7	1.00	25	.04	.06	56	-
B904	1/4	6.4	.46	11.7	250	1.7	1.50	38	.05	.07	56	82*
B905	5/16	7.9	.55	14.0	250	1.7	2.00	51	.08	.12	56	-
B906	3/8	9.5	.64	16.3	250	1.7	3.00	76	.09	.13	56	82*
B908	1/2	12.7	.78	19.8	250	1.7	3.00	76	.13	.19	56	82*
B910	5/8	15.8	.92	23.4	250	1.7	4.00	102	.20	.30	56	82*

Construction

Tube: Specially Formulated Polyurethane

Reinforcement: Fiber

Cover: Specially Formulated Polyurethane

Operating Parameters

Temperature Range:

- -40°F (-40°C) to +200°F (93°C)
- Water/and water based fluids up to +130°F (+54°C)

Change in length at Max. Working Pressure: +/-2%

Min. Burst Pressure is 4x Max. Working Pressure at 73°F (23°C)

Fittings

56 Series – pg. E-13

82 Series – Available from Parker Hose Products Division

For most Parker products, Crimp Die Selection charts can be found online at www.parker.com/crimpsource

Access instructions are on pg. G-14

Colors

- Red
- Black (BLK)

Notes

- *Temperature and pressure reduced with 82 series Push-Lok Fitting:
-20°F to +100°F (-29°C to +38°C)
100 psi maximum working pressure
- Non-perforated cover



WARNING

This product can expose you to chemicals including Nickel Compounds which is known to the State of California to cause cancer and Toluene, which is known to the State of California to cause birth defects or other reproductive harm. For more information go to www.P65Warnings.ca.gov

5CNG – Electrically Conductive Compressed Natural Gas Hose



Features

- Twin constructions available

Certifications

Conforms to:

- ANSI/CSA NGV 4.2*CSA 12.52 (Class A, Class D)
- ECE R110 CNG Class 6
- ANSI NGV 3.1*CSA 12.3 (Class B - P36) 5CNG-8 only
- NFPA 52
- CSA Certified (www.csagroup.org)

Applications/Markets



- CNG Dispenser/Refueling
- Fleet Transit/On-Vehicle
- CNG Fuel Transfer

[Visit the webpage](#)

Part Number	Nominal I.D.		Maximum O.D.		Maximum Working Pressure		Minimum Bend Radius		Weight	
	inch	mm	inch	mm	psi	MPa	inch	mm	lbs./ft.	kg./mtr.
#										
5CNG-4	1/4	6.4	.55	14.0	5,000	34.5	2.00	51	.08	.11
5CNG-6	3/8	9.5	.65	16.5	5,000	34.5	3.00	76	.09	.13
5CNG-8	1/2	12.7	.90	22.9	5,000	34.5	4.00	102	.21	.31
5CNG-12	3/4	19.1	1.19	30.2	5,000	34.5	7.50	191	.24	.36
5CNG-16	1	25.4	1.59	40.4	5,000	34.5	10.00	254	.36	.53

Construction

Tube: Electrically Conductive Nylon
 Reinforcement: Fiber
 Cover: Polyurethane

Color

- Red

Operating Parameters

Temperature Range:
 • -40°F (-40°C) to +185°F (85°C)
 Vacuum Rating: 28 inch Hg
 Change in length at Max. Working Pressure: +/-2%
 Min. Burst Pressure is 4x Max. Working Pressure at 73°F (23°C)

Notes

- Assemblies only - CNG hose must be assembled at the factory or by a Parflex approved facility
- Perforated cover
- Appropriate wire and vinyl guards must be used on ANSI/CSA compliant single-line and twin-line bonded hose assemblies. -4 to -8 SS wire guards - pg. F-19
 -12 & -16 Vinyl guards - pg. F-18

Fittings

CG Series - pg. E-56

Accessories

- 5PSG - Stainless steel spring guard
- CNGG5 - Vinyl hose guard

For most Parker products, Crimp Die Selection charts can be found online at www.parker.com/crimpsource
 Access instructions are on pg. G-14



WARNING

This product can expose you to chemicals including Carbon Black Extracts, which is known to the State of California to cause cancer and Toluene, which is known to the State of California to cause birth defects or other reproductive harm. For more information go to www.P65Warnings.ca.gov.

CNGRP – Regulated Pressure Natural Gas Hose - Electrically Conductive



Features

- For use downstream of pressure regulator

Certifications

Conforms to:

- ANSI CSA NGV 3.1
- NFPA 52
- CSA 12.3, Class C
- CSA Certified (www.csagroup.org)

Applications/Markets



- On-vehicle
 - Approved for both under body and engine compartment installations

[Visit the webpage](#)

Part Number	Nominal I.D.		Maximum O.D.		Maximum Working Pressure		Minimum Bend Radius		Weight	
	inch	mm	inch	mm	psi	MPa	inch	mm	lbs./ft.	kg./mtr.
#										
CNGRP-10	1/2	12.7	0.89	22.6	500	3.45	4.00	102	.26	.39
CNGRP-12	5/8	15.9	1.04	26.4	500	3.45	5.00	127	.30	.45

Construction

Tube: Electrically Conductive Nylon

Reinforcement: Stainless Steel

Cover: TPV

Colors

- Red

Operating Parameters

Temperature Range:

- -40°F (-40°C) to +250°F (121°C)

Change in length at Max. Working Pressure: +2%/-4%

Min. Burst Pressure is 4x Max. Working Pressure at 73°F (23°C)

Notes

- For use with natural gas only
- Factory-made assemblies only
- For sizes 3, 4 and 6 please contact the division for information on 8LPG hose which is certified according to ECE R 67 class 1, ECE R110 and AS/NZS 1869

Fittings

91N Series – pg. E-34

10691N-10-10C, 10691N-8-10C, 10691N-12-12C,
1JC91N-12-12C, 1TU91N-10-12C, 1TU91N-12-12C,
1AL91N-10-12C, 1AL91N-12-12C, 10691N-10-12C

For most Parker products, Crimp Die Selection charts can be found online at www.parker.com/crimpsource

Access instructions are on pg. G-14



WARNING

This product can expose you to chemicals including Carbon Black Extracts, which is known to the State of California to cause cancer and Toluene, which is known to the State of California to cause birth defects or other reproductive harm. For more information go to www.P65Warnings.ca.gov.

HLB – Lubrication Line Hose



Features

- HLB remote lubrication system versus 1/4" rubber hoses can save money per line in reduced component and installation labor costs
- Unique GK bulkhead hose fittings with integrated nipple can save money per zerk connection in unnecessary adapter costs
- Compact 1/8" hoses save hundreds of dollars of waste in your operation by eliminating gallons of unnecessary "in-line" grease versus larger bore rubber hoses

Certifications

- MSHA Accepted

Applications/Markets



- Grease and lubrication lines
- Agriculture
- Material Handling
- Mobile Equipment
- Transportation
- General purpose hydraulic systems

Construction

- Industrial

[Visit the webpage](#)

Part Number	Nominal I.D.		Maximum O.D.		Maximum Working Pressure		Minimum Bend Radius		Weight		Permanent Fitting Series	Field Attachable Series
	inch	mm	inch	mm	psi	MPa	inch	mm	lbs./ft.	kg./mtr.		
#												
HLB02	1/8	3.2	.32	8.1	3,000	20.7	.50	13	.03	.04	CY	BU
HLB03	3/16	4.8	.41	10.4	3,000	20.7	.75	19	.06	.08	CY	BU

Construction

Tube: Copolyester
Reinforcement: Fiber
Cover: Polyurethane

Operating Parameters

Temperature Range:

- -40°F (-40°C) to +212°F (100°C)
- Synthetic, synthetic blend, water, and water/oil emulsion hydraulic fluids limited to +135°F (+57°C)
- BU Series Field Attachable Fitting limited to 120°F (53°C)

Vacuum Rating: 28 inch Hg

Change in length at Max. Working Pressure: +/-3%

Min. Burst Pressure is 4x Max. Working Pressure at 73°F (23°C)

Fittings

CY Series – pg. E-62 BU Series – pg. E-55

For most Parker products, Crimp Die Selection charts can be found online at www.parker.com/crimpsource

Access instructions are on pg. G-14

Colors

- Black

Notes

- Non-perforated cover
- Not for use as a whip hose on hand-operated grease guns



WARNING

This product can expose you to chemicals including Nickel Compounds which is known to the State of California to cause cancer and Toluene, which is known to the State of California to cause birth defects or other reproductive harm. For more information go to www.P65Warnings.ca.gov

MSH – Marine Steering Fast Response Hose



Features

- Fast, accurate response
- Permanent or field attachable Fittings
- Salt water, corrosion resistant

Applications/Markets



- Marine hydraulic steering systems

[Visit the webpage](#)

Part Number	Nominal I.D.		Maximum O.D.		Maximum Working Pressure		Minimum Bend Radius		Weight		Permanent Fitting Series	Field Attachable Series
	inch	mm	inch	mm	psi	MPa	inch	mm	lbs./ft.	kg./mtr.		
#												
MSH-5	5/16	7.9	.48	12.2	1,000	6.9	2.25	57	.05	.07	MS	MS
MSH-6	3/8	9.5	.59	15.0	1,000	6.9	3.00	76	.07	.11	MS	MS

Construction

Tube: Nylon
Reinforcement: Fiber
Cover: Polyurethane

Operating Parameters

Temperature Range:

- -40°F (-40°C) to +200°F (93°C)

 Vacuum Rating: 28 inch Hg
 Change in length at Max. Working Pressure: +/-2%
 Min. Burst Pressure is 4x Max. Working Pressure at 73°F (23°C)

Fittings

MS Series – pg. E-65
 For most Parker products, Crimp Die Selection charts can be found online at www.parker.com/crimpsource
 Access instructions are on pg. G-14

Colors

- Black

Notes

- Non-perforated cover
- Bend restrictions are available only for permanent Fittings
- HBR (Hose Bend Restrictor) available for Marine Steering Hose Assemblies. See Hose Guard in Tooling Equipment and Accessories Section pg. F-18



WARNING

This product can expose you to chemicals including Nickel Compounds which is known to the State of California to cause cancer and Toluene, which is known to the State of California to cause birth defects or other reproductive harm. For more information go to www.P65Warnings.ca.gov

MSXL Marine Hydraulic Steering Hose



Features

- Fast, accurate response in marine steering systems
- Low volumetric expansion
- Salt water resistant cover

Applications/Markets



- Marine hydraulic steering systems

[Visit the webpage](#)

Part Number	Nominal I.D.		Maximum O.D.		Maximum Working Pressure		Minimum Bend Radius		Weight		Permanent Fitting Series
	inch	mm	inch	mm	psi	MPa	inch	mm	lbs./ft.	kg./mtr.	
MSXL-5	5/16	7.9	.50	12.7	1,500	10.3	2-1/4	57	.05	.07	MS

Construction

Tube: Nylon

Reinforcement: Aramid Fiber

Cover: Polyurethane

Operating Parameters

Temperature Range:

- -40°F (-40°C) to +185°F (85°C)

Vacuum Rating: 28 inch Hg

Change in length at Max. Working Pressure: +/-2%

Min. Burst Pressure is 4x Max. Working Pressure at 73°F (23°C)

Fittings

MS Series Permanent Crimp – pg. E-65

For most Parker products, Crimp Die Selection charts can be found online at www.parker.com/crimpsource

Access instructions are on pg. G-14

Colors

- Black

Notes

- MS Series Permanent Crimp Fittings only
- Non-perforated cover
- HBR (Hose Bend Restrictor) available for Marine Steering Hose Assemblies. See Hose Guard in Tooling Equipment and Accessories Section pg. F-18



WARNING

This product can expose you to chemicals including Nickel Compounds which is known to the State of California to cause cancer and Toluene, which is known to the State of California to cause birth defects or other reproductive harm. For more information go to www.P65Warnings.ca.gov

PTH – Marine Power Tilt Hose

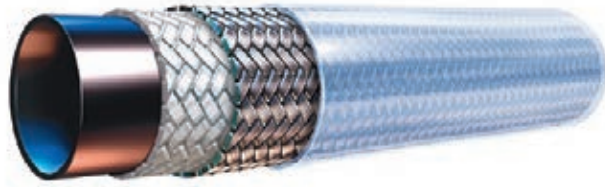

Features

- Compact design
- Abrasion resistant polyurethane cover
- Excellent flexibility
- Corrosion resistant

Applications/Markets



- Power tilt mechanisms for outboard and stern drive engines
- Trim Tab assemblies
- Jack Plate assemblies

[Visit the webpage](#)

Part Number	Nominal I.D.		Maximum O.D.		Maximum Working Pressure		Minimum Bend Radius		Weight		Permanent Fitting Series
	inch	mm	inch	mm	psi	MPa	inch	mm	lbs./ft.	kg./mtr.	
PTH-3	3/16	4.8	.43	10.9	3,000	20.7	0.75	19	.08	.11	92

Construction

Tube: Nylon

Reinforcement: Fiber and Stainless Steel Wire

Cover: Polyurethane

Operating Parameters

Temperature Range:

- -40°F (-40°C) to +212°F (100°C)

Vacuum Rating: 28 inch Hg

Change in length at Max. Working Pressure: +/-2%

Min. Burst Pressure is 4x Max. Working Pressure at 73°F (23°C)

Fittings

92 Series – pg. E-43

For most Parker products, Crimp Die Selection charts can be found online at www.parker.com/crimpsource

Access instructions are on pg. G-14

Colors

- Clear

Notes

- Non-perforated cover
- Also available as custom order with black cover
- SS wire overbraid for enhanced kink resistance and cut through protection



WARNING

This product can expose you to chemicals including Nickel Compounds which is known to the State of California to cause cancer and Toluene, which is known to the State of California to cause birth defects or other reproductive harm. For more information go to www.P65Warnings.ca.gov

S5N – Predator® Hose (Water Jetting/Lateral Cleaning)



Features

- Easily identified lime green cover signifies 4000 psi constant pressure
- Slim profile and light weight provide easy handling and routing

Certifications

- NSWMA (National Solid Waste Management Assoc.)
- WASTEC (Waste Equipment Technology Assoc.)
- WEMI (Waste Equipment Management Inst.)

Applications/Markets



- High-pressure water equipment for cleaning or debris removal in lateral sewer lines

[Visit the webpage](#)

Part Number	Nominal I.D.		Maximum O.D.		Maximum Working Pressure		Minimum Bend Radius		Weight		Permanent Fitting Series
	inch	mm	inch	mm	psi	MPa	inch	mm	lbs./ft.	kg./mtr.	
S508N	1/2	12.7	.81	20.6	4000	28	4.00	102	.16	.24	56

Construction

Tube: Gray Nylon
 Reinforcement: Aramid Fiber
 Cover: Polyurethane

Operating Parameters

Temperature Range:
 • -40°F (-40°C) to +135°F (57°C)
 Vacuum Rating: 28 inch Hg
 Change in length at Max. Working Pressure: +/-2%
 Min. Burst Pressure is 4x Max. Working Pressure at 73°F (23°C)

Fittings

56 Series - pg. E-13
 For most Parker products, Crimp Die Selection charts can be found online at www.parker.com/crimpsource
 Access instructions are on pg. G-14

Colors

- Green

Notes

- All standard assembly lengths coupled with rigid male pipe each end
- Not for use in hydraulic applications
- Perforated cover



WARNING

This product can expose you to chemicals including Nickel Compounds which is known to the State of California to cause cancer and Toluene, which is known to the State of California to cause birth defects or other reproductive harm. For more information go to www.P65Warnings.ca.gov

S6 – Predator[®] Hose (Sewer Cleaning)



Features

- Easily identified orange cover signifies 2500 psi constant pressure
- Bonded construction provides excellent kink resistance and flexibility

Certifications

- NSWMA (National Solid Waste Management Assoc.)
- WASTEC (Waste Equipment Technology Assoc.)
- WEMI (Waste Equipment Management Inst.)

Applications/Markets



- High-pressure and high-volume water equipment for cleaning or debris removal in large sewer lines

[Visit the webpage](#)

Part Number	Nominal I.D.		Maximum O.D.		Maximum Working Pressure		Minimum Bend Radius		Weight		Permanent Fitting Series
	inch	mm	inch	mm	psi	MPa	inch	mm	lbs./ft.	kg./mtr.	
#											
S612	3/4	19.1	1.14	29.0	2,500	17.2	4.00	102	.29	.43	SQ/HY
S616	1	25.4	1.41	35.8	2,500	17.2	6.00	152	.38	.57	SQ/HY

Construction

Tube: Gray Copolyester
 Reinforcement: Fiber
 Cover: Polyurethane

Operating Parameters

Temperature Range:
 • -40°F (-40°C) to +135°F (57°C)
 Vacuum Rating: 28 inch Hg
 Change in length at Max. Working Pressure: +/-2%
 Min. Burst Pressure is 2.5x Max. Working Pressure at 73°F (23°C)

Fittings

SQ Series (Swage Only)- pg. E-68
 HY Series - Available from Parker Hose Products Division
 For most Parker products, Crimp Die Selection charts can be found online at www.parker.com/crimpsource
 Access instructions are on pg. G-14

Colors

- Orange

Notes

- All standard assembly lengths coupled with rigid male pipe each end
- Not for use in hydraulic applications
- Perforated cover



WARNING

This product can expose you to chemicals including Nickel Compounds which is known to the State of California to cause cancer and Toluene, which is known to the State of California to cause birth defects or other reproductive harm. For more information go to www.P65Warnings.ca.gov

S9 – Predator[®] Hose (Sewer Cleaning)



Features

- Easily identified blue cover signifies 3000 psi constant pressure
- Bonded construction provides excellent kink resistance and flexibility

Certifications

- NSWMA (National Solid Waste Management Assoc.)
- WASTECH (Waste Equipment Technology Assoc.)
- WEMI (Waste Equipment Management Inst.)

Applications/Markets



- High-pressure and high-volume water equipment for cleaning or debris removal in large sewer lines

[Visit the webpage](#)

Part Number	Nominal I.D.		Maximum O.D.		Maximum Working Pressure		Minimum Bend Radius		Weight		Permanent Fitting Series
	inch	mm	inch	mm	psi	MPa	inch	mm	lbs./ft.	kg./mtr.	
#											
S912	3/4	19.1	1.15	29.2	3,000	20.7	4.00	102	.30	.45	SQ/HY
S916	1	25.4	1.47	37.3	3,000	20.7	8.00	203	.46	.68	SQ/HY

Construction

Tube: Gray Copolyester
 Reinforcement: Fiber
 Cover: Polyurethane

Operating Parameters

Temperature Range:
 • -40°F (-40°C) to +135°F (57°C)
 Vacuum Rating: 28 inch Hg
 Change in length at Max. Working Pressure: +/-2%
 Min. Burst Pressure is 2.5x Max. Working Pressure at 73°F (23°C)

Fittings

SQ Series (Swage Only)- pg. E-68
 HY Series - Available from Parker Hose Products Division
 For most Parker products, Crimp Die Selection charts can be found online at www.parker.com/crimpsource
 Access instructions are on pg. G-14

Colors

- Blue

Notes

- All standard assembly lengths coupled with rigid male pipe each end
- Not for use in hydraulic applications
- Perforated cover



WARNING

This product can expose you to chemicals including Nickel Compounds which is known to the State of California to cause cancer and Toluene, which is known to the State of California to cause birth defects or other reproductive harm. For more information go to www.P65Warnings.ca.gov

919/919B – PTFE Hose

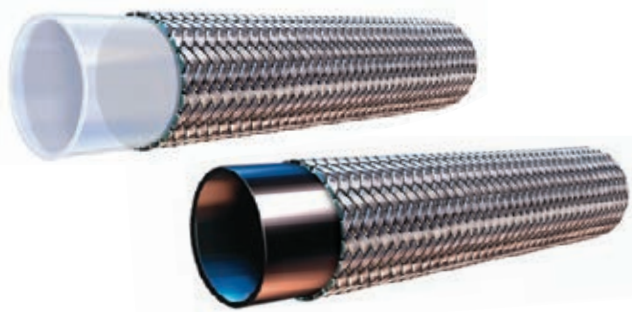

Features

- Excellent chemical compatibility
- Handles extreme temperatures to +450°F
- Environmentally safe
- Resists moisture
- Low friction minimizes pressure drops and deposits

Certifications

- Meets/Exceeds SAE 100R14A - 919
- Meets/Exceeds SAE 100R14B - 919B
- FDA 21 CFR 177.1550 (Natural tube)

Applications/Markets



- Chemical Transfer Lines
- General Hydraulics
- Compressed Air/Gases
- Adhesive Dispensing
- Coolant Lines

[Visit the webpage](#)

Part Number		Nominal I.D.		Maximum O.D.		Maximum Working Pressure		Minimum Bend Radius		Vac. Rating Hg./73°F	Weight		Permanent Fitting Series	Field Attachable Series
#	#													
Natural	Static-Dissipative	inch	mm	inch	mm	psi	MPa	inch	mm	inch	lbs./ft.	kg./mtr.		
919-4	919B-4	3/16	4.8	0.33	8.2	3,000	20.7	2.00	51	28	.06	.09	91N	90
919-5	919B-5	1/4	6.4	0.40	10.1	3,000	20.7	3.00	76	28	.09	.13	91N	90
919-6	919B-6	5/16	7.9	0.46	11.6	2,500	17.2	4.00	102	28	.10	.15	91N	90
919-8	919B-8	13/32	10.3	0.56	14.3	2,000	13.8	5.00	127	28	.13	.19	91N	90
919-10	-	1/2	12.7	0.66	16.8	1,500	10.3	6.50	165	28	.15	.22	91N	90
919-12	-	5/8	15.9	0.77	19.6	1,200	8.3	7.50	191	12	.19	.28	91N	90
919-16	-	7/8	22.2	1.06	26.9	1,000	6.9	9.00	229	14	.27	.40	91N	90
919-20	-	1-1/8	28.6	1.32	33.5	625	4.3	16.00	406	10	.39	.58	91	90

Construction

Tube: 919 - Natural FDA Compliant PTFE
919B - Black Static-Dissipative PTFE

Reinforcement: 304 Stainless Steel Braid

Operating Parameters

Temperature Range:

- -100°F (-73°C) to +450°F (232°C)

Change in length at Max. Working Pressure: +2% to -4%

Min. Burst Pressure is 4x Max. Working Pressure at 73°F (23°C)

Fittings

90 Series – pg. E-29 91N Series – pg. E-34

For most Parker products, Crimp Die Selection charts can be found online at www.parker.com/crimpsource

Access instructions are on pg. G-14

Notes

- Use hose type 919B with static-dissipative core tube when conveying non-conducting fluids such as oils, paints, fuels, steam, etc.
- Constructed with minimum .030" PTFE tube wall thickness



WARNING

This product can expose you to chemicals including Tetrafluoroethylene, which is known to the State of California to cause cancer. For more information go to www.P65Warnings.ca.gov.

919J – Silicone Covered PTFE Hose



Features

- Silicone cover provides a clean, smooth cover to protect the stainless steel wire reinforcement against wear, fraying and contaminants
- Steam cleanable

Certifications

- Meets/Exceeds SAE 100R14A
- FDA 21 CFR 177.1550

Applications/Markets



- Chemical Transfer Lines
- General Hydraulics
- Compressed Air/Gases
- Adhesive Dispensing
- Coolant Lines

[Visit the webpage](#)

Part Number	Nominal I.D.		Maximum O.D.		Maximum Working Pressure		Minimum Bend Radius		Vac. Rating Hg./73°F	Weight		Permanent Fitting Series
	inch	mm	inch	mm	psi	MPa	inch	mm		lbs./ft.	kg./mtr.	
#												
919J-4-RED	3/16	4.8	0.45	11.4	3,000	20.7	2.00	51	28	.12	.18	91N
919J-5-RED	1/4	6.4	0.52	13.2	3,000	20.7	3.00	76	28	.14	.21	91N
919J-6-RED	5/16	7.9	0.58	14.7	2,500	17.2	4.00	102	28	.17	.25	91N
919J-8-RED	13/32	10.3	0.68	17.3	2,000	13.8	5.00	127	28	.20	.30	91N
919J-10-RED	1/2	12.7	0.78	19.8	1,500	10.3	6.50	165	28	.24	.35	91N
919J-12-RED	5/8	15.9	0.91	23.1	1,200	8.3	7.50	191	12	.29	.43	91N
919J-16-RED	7/8	22.2	1.15	29.2	1,000	6.9	9.00	229	14	.38	.56	91N

Construction

Tube: Natural FDA compliant PTFE

Reinforcement: 304 Stainless Steel Braid

Cover: Extruded Silicone

Operating Parameters

Temperature Range:

- -40°F (-40°C) to +450°F (232°C)

Change in length at Max. Working Pressure: +2% to -4%

Min. Burst Pressure is 4x Max. Working Pressure at 73°F (23°C)

Fittings

91N Series – pg. E-34

For most Parker products, Crimp Die Selection charts can be found online at www.parker.com/crimpsource

Access instructions are on pg. G-14

Colors

- Red

Notes

- Cover must be skived prior to fitting attachment
- Constructed with minimum .030" PTFE tube wall thickness



WARNING

This product can expose you to chemicals including Tetrafluoroethylene, which is known to the State of California to cause cancer. For more information go to www.P65Warnings.ca.gov.

919U – High Abrasion Resistance PTFE Hose



Features

- Non-Marring, abrasion resistant polyurethane cover protects the stainless steel wire reinforcement against wear, fraying and contaminants

Certifications

- Meets/Exceeds SAE 100R14A but operates at a temperature range of -40°F to +275°F
- FDA 21 CFR 177.1550

Applications/Markets



- Chemical Transfer Lines
- General Hydraulics
- Compressed Air/Gases
- Adhesive Dispensing
- Coolant Lines

[Visit the webpage](#)

Part Number	Nominal I.D.		Maximum O.D.		Maximum Working Pressure		Minimum Bend Radius		Vac. Rating Hg./73°F	Weight		Permanent Fitting Series
	inch	mm	inch	mm	psi	MPa	inch	mm		lbs./ft.	kg./mtr.	
#												
919U-4	3/16	4.8	0.37	9.4	3,000	20.7	2.00	51	28	.08	.13	91N
919U-6	5/16	7.9	0.51	13.0	2,500	17.2	4.00	102	28	.13	.20	91N
919U-8	13/32	10.3	0.61	15.5	2,000	13.8	5.00	127	28	.15	.22	91N
919U-12	5/8	15.9	0.84	21.4	1,200	8.3	7.50	191	12	.22	.33	91N
919U-16	7/8	22.2	1.12	28.5	1,000	6.9	9.00	229	14	.31	.47	91N

Construction

Tube: Natural FDA compliant PTFE
 Reinforcement: 304 Stainless Steel Braid
 Cover: Polyurethane

Operating Parameters

Temperature Range:

- -40°F (-40°C) to +275°F (135°C)

Change in length at Max. Working Pressure: +2% to -4%

Min. Burst Pressure is 4x Max. Working Pressure at 73°F (23°C)

Fittings

91N Series – pg. E-34

For most Parker products, Crimp Die Selection charts can be found online at www.parker.com/crimpsource

Access instructions are on pg. G-14

Colors

- Black

Notes

- Cover must be skived prior to fitting attachment
- Constructed with minimum .030" PTFE tube wall thickness



WARNING

This product can expose you to chemicals including Tetrafluoroethylene, which is known to the State of California to cause cancer. For more information go to www.P65Warnings.ca.gov.

929/929B – Heavy Wall PTFE Hose



Features

- Excellent kink resistance
- Enhanced resistance to gas permeation due to increased PTFE wall thickness (.040")

Certifications

- Meets/Exceeds SAE 100R14A - 929
- Meets/Exceeds SAE 100R14B - 929B
- FDA 21 CFR 177.1550 (Natural tube)

Applications/Markets



- Chemical Transfer Lines
- General Hydraulics
- Compressed Air/Gases
- Adhesive Dispensing
- Coolant Lines

[Visit the webpage](#)

Part Number		Nominal I.D.		Maximum O.D.		Maximum Working Pressure		Minimum Bend Radius		Vac. Rating Hg./73°F	Weight		Permanent Fitting Series
#	#												
Natural	Static-Dissipative	inch	mm	inch	mm	psi	MPa	inch	mm	inch	lbs./ft.	kg./mtr.	
929-4	929B-4	3/16	4.8	0.35	8.9	3,000	20.7	2.00	51	28	.08	.12	91N
929-6	929B-6	5/16	7.9	0.47	11.9	2,500	17.2	4.00	102	28	.12	.18	91N
929-8	929B-8	13/32	10.3	0.59	15.0	2,000	13.8	4.60	117	28	.16	.23	91N
-	929B-12	5/8	15.9	0.79	20.1	1,200	8.3	6.50	165	12	.19	.28	91N
-	929B-16	7/8	22.2	1.14	29.0	1,250	8.6	7.40	188	12	.49	.73	91N

Construction

Tube: 929 - Natural FDA Compliant PTFE
929B - Black Static-Dissipative PTFE

Reinforcement: 304 Stainless Steel Braid

Operating Parameters

Temperature Range:

- -100°F (-73°C) to +450°F (232°C)

Change in length at Max. Working Pressure: +2% to -4%

Min. Burst Pressure is 4x Max. Working Pressure at 73°F (23°C)

Fittings

91N Series - pg. E-34

For most Parker products, Crimp Die Selection charts can be found online at www.parker.com/crimpsource

Access instructions are on pg. G-14

Notes

- Use hose type 929B with static-dissipative core tube when conveying non-conducting fluids such as oils, paints, fuels, steam, etc.
- Constructed with minimum .040" PTFE tube wall thickness



WARNING

This product can expose you to chemicals including Tetrafluoroethylene, which is known to the State of California to cause cancer. For more information go to www.P65Warnings.ca.gov.

929BJ – Silicone Covered PTFE Hose (with Static-Dissipative Tube)



Features

- Silicone cover protects SS wire reinforcement against wear and fraying, up to 450°F
- Silicone cover provides clean, smooth cover and prevents contaminants from accumulating in braid
- Excellent kink resistance
- Enhanced resistance to gas permeation due to increased PTFE wall thickness
- Steam cleanable

Applications/Markets



- Vacuum lines for high temperature autoclaves
- General Hydraulics
- Compressed Air/Gases

[Visit the webpage](#)

Part Number	Nominal I.D.		Maximum O.D.		Maximum Working Pressure		Minimum Bend Radius		Vac. Rating Hg./73°F	Weight		Permanent Fitting Series
	inch	mm	inch	mm	psi	MPa	inch	mm		inch	lbs./ft.	
#												
929BJ-4	3/16	4.8	0.58	14.7	3,000	20.7	2.00	51	28	.17	.25	91N
929BJ-6	5/16	7.9	0.70	17.8	2,500	17.2	4.00	102	28	.23	.34	91N
929BJ-8	13/32	10.3	0.81	20.6	2,000	13.8	4.60	117	28	.29	.43	91N
929BJ-12	5/8	15.9	1.04	26.4	1,200	8.3	6.50	165	12	.43	.64	91N
929BJ-16	7/8	22.2	1.36	34.5	1,250	8.6	7.40	188	12	.78	1.16	91N

Construction

Tube: Black Static-Dissipative PTFE
 Reinforcement: 304 Stainless Steel Braid
 Cover: Silicone

Operating Parameters

Temperature Range:

- -65°F (-54°C) to +450°F (232°C)

Change in length at Max. Working Pressure: +2% to -4%

Min. Burst Pressure is 4x Max. Working Pressure at 73°F (23°C)

Fittings

91N Series – pg. E-34

For most Parker products, Crimp Die Selection charts can be found online at www.parker.com/crimpsource

Access instructions are on pg. G-14

Colors

- Brown

Notes

- Cover must be skived prior to fitting attachment
- Constructed with minimum .040" PTFE tube wall thickness



WARNING

This product can expose you to chemicals including Tetrafluoroethylene, which is known to the State of California to cause cancer. For more information go to www.P65Warnings.ca.gov.

939/939B – Convoluted PTFE Hose



Features

- Excellent flexibility
- Exceptional kink resistance

Certifications

- FDA 21 CFR 177.1550 (Natural tube)

Applications/Markets



- Chemical Transfer
- General Hydraulics
- Hose applications requiring tight routings

[Visit the webpage](#)

Part Number		Nominal I.D.		Maximum O.D.		Maximum Working Pressure		Minimum Bend Radius		Vac. Rating Hg./73°F	Weight		Permanent Fitting Series
#	#												
Natural	Static-Dissipative	inch	mm	inch	mm	psi	MPa	inch	mm	inch	lbs./ft.	kg./mtr.	
939-6	939B-6	3/8	9.5	0.59	15.0	1,500	10.3	2.25	57	28	.12	.18	93N
939-8	939B-8	1/2	12.7	0.79	20.1	1,350	9.3	2.88	73	28	.21	.31	93N
939-10	939B-10	5/8	15.9	0.88	22.4	1,000	6.9	3.00	76	28	.24	.36	93N
939-12	939B-12	3/4	19.1	1.09	27.7	1,100	7.6	3.75	95	28	.32	.47	93N
939-16	939B-16	1	25.4	1.33	33.8	1,000	6.9	5.00	127	28	.45	.67	93N
939-20	939B-20	1-1/4	31.8	1.75	44.5	1,000	6.9	6.25	159	20*	.70	1.04	93N
939-24	939B-24	1-1/2	38.1	2.05	52.1	750	5.2	7.50	191	12*	.80	1.18	93N
939-32	939B-32	2	50.8	2.56	65.0	250	1.7	10.00	254	5*	1.01	1.50	93N

Construction

Tube: 939 - Natural FDA Compliant PTFE
939B - Black Static-Dissipative PTFE

Reinforcement: 304 Stainless Steel Braid

Operating Parameters

Temperature Range:

- -100°F (-73°C) to +450°F (232°C)

Change in length at Max. Working Pressure: +2% to -4%

Min. Burst Pressure is 4x Max. Working Pressure at 73°F (23°C)

Fittings

93N Series - pg. E-44

For most Parker products, Crimp Die Selection charts can be found online at www.parker.com/crimpsource

Access instructions are on pg. G-14

Notes

- Use hose type 939B with static-dissipative core tube when conveying non-conducting fluids such as oils, paints, fuels, steam, etc.
- *28 in/Hg can be obtained by using 2799 internal spring guard. See pg. F-20



WARNING

This product can expose you to chemicals including Tetrafluoroethylene, which is known to the State of California to cause cancer. For more information go to www.P65Warnings.ca.gov.

944B – 4,000-4,500 psi W.P. High Temp Hose



Features

- Excellent chemical compatibility
- Resists moisture
- Low friction minimizes pressure drops and deposits

Applications/Markets



- General Hydraulics
- Chemical Transfer
- Compressed Air/Gases

[Visit the webpage](#)

Part Number	Nominal I.D.		Maximum O.D.		Maximum Working Pressure		Minimum Bend Radius		Vac. Rating Hg./73°F	Weight	
	inch	mm	inch	mm	psi	MPa	inch	mm		inch	lbs./ft.
#											
944B-6	5/16	8	.49	12	4,500	31.0	2.50	64	28	.17	.24
944B-8	7/16	11	.62	16	4,500	31.0	2.88	73	28	.25	.35
944B-10	1/2	13	.73	19	4,000	27.6	3.25	83	28	.31	.45
944B-12	5/8	16	.99	25	4,000	27.6	4.00	102	28	.74	1.05
944B-16	29/32	23	1.25	32	4,000	27.6	5.00	127	28	1.09	1.55

Construction

Tube: Black Static-Dissipative PTFE
Reinforcement: 304 Stainless Steel Braid

Fittings

94 Series – pg. E-47

Operating Parameters

Temperature Range:

- -65°F (-54°C) to +400°F (204°C)

Change in length at Max. Working Pressure: +/-2%

Min. Burst Pressure is 3x Max. Working Pressure at 73°F (23°C)

Notes

- Factory-made assemblies only
- Reduce pressure to 3,000 psi (20.7MPa) for pressure impulse applications



WARNING

This product can expose you to chemicals including Tetrafluoroethylene, which is known to the State of California to cause cancer. For more information go to www.P65Warnings.ca.gov.

955B – 5,500 psi W.P. High Temp Hose



Features

- Excellent chemical compatibility
- Resists moisture
- Low friction minimizes pressure drops and deposits

Applications/Markets

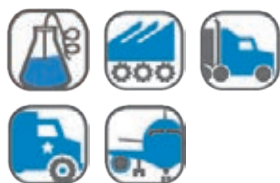

- General Hydraulics
- Chemical Transfer
- Compressed Air/Gases
- Ground Support

[Visit the webpage](#)

Part Number	Nominal I.D.		Maximum O.D.		Maximum Working Pressure		Minimum Bend Radius		Vac. Rating Hg./73°F	Weight	
	inch	mm	inch	mm	psi	MPa	inch	mm		inch	lbs./ft.
#											
955B-4	15/64	5.9	0.50	12.7	5,500	37.9	3.00	76	28	.23	.34
955B-6	5/16	7.9	0.62	15.7	5,500	37.9	5.00	127	28	.24	.35
955B-8	7/16	11.1	0.75	19.1	5,500	37.9	5.75	146	28	.46	.68
955B-10	1/2	12.7	0.91	23.1	5,500	37.9	6.50	165	28	.91	1.34
955B-12	5/8	15.9	1.08	27.4	5,500	37.9	7.75	197	28	.92	1.36
955B-16	29/32	23.0	1.36	34.5	5,500	37.9	9.63	245	28	1.20	1.77

Construction

Tube: Black Static-Dissipative PTFE

Reinforcement: Multiple high density braids of 304 Stainless Steel

Operating Parameters

Temperature Range:

- -65°F (-54°C) to +400°F (204°C)

Change in length at Max. Working Pressure: +/-2%

Min. Burst Pressure is 16,000 psi at 73°F (23°C)

Fittings

95 Series – pg. E-47

Notes

- Factory-made assemblies only
- Reduce operating pressure to 4000 psi (27.6 MPa) for impulse service applications



WARNING

This product can expose you to chemicals including Tetrafluoroethylene, which is known to the State of California to cause cancer. For more information go to www.P65Warnings.ca.gov.

STW/STB - "TRUE BORE"

Smoothbore PTFE Hose, Stainless Steel Braid

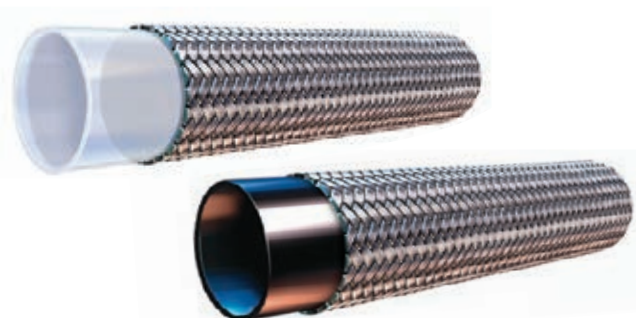

Features

- High temperature hose
- Excellent chemical compatibility
- Resists moisture
- Low friction minimizes pressure drops and deposits

Compliances

- FDA 21 CFR 177.1550 (Natural tube)
- USP Class VI
- ISO 10993 Sections 5, 6, 10, 11

Applications/Markets



- Fluid Handling
- Chemical Transfer
- Paint
- Pharmaceutical
- Food & Beverage
- Cosmetics

[Visit the webpage](#)

Part Number		Nominal I.D.		Nominal O.D.		Maximum Working Pressure 73°F / 23°C		Minimum Bend Radius		Vac. Rating Hg./73°F	Weight		Permanent Fitting Series
#	#												
Natural	Static-Dissipative	inch	mm	inch	mm	psi	bar	inch	mm	inch	lbs./ft.	kg./mtr.	
04-STW	04-STB	1/4	6.4	.37	9.4	3,000	207	3	76	28	.08	.13	PAGE
06-STW	06-STB	3/8	9.5	.51	13.0	2,000	138	5	127	28	.11	.16	PAGE
08-STW	08-STB	1/2	10.3	.63	16.0	1,750	121	6.50	165	28	.16	.24	PAGE
12-STW	12-STB	3/4	19.1	.88	22.4	1,000	69	8.50	216	28	.20	.30	PAGE
16-STW	16-STB	1	25.4	1.13	28.7	1,000	69	12	305	20	.33	.49	PAGE
20Z-STW	20Z-STB	1-1/4	31.8	1.52	38.6	1,000	69	14	356	18	.68	1.02	PAGE
24Z-STW	24Z-STB	1-1/2	38.1	1.73	43.9	900	62	15	381	15	.79	1.18	PAGE

Construction

Tube: STW - Natural FDA Compliant PTFE
STB - Black Static-Dissipative PTFE

Reinforcement: 304 Stainless Steel Braid

Operating Parameters

Temperature Range:

- -100°F (-73°C) to +450°F (232°C)

Change in length at Max. Working Pressure: +2% to -4%

Min. Burst Pressure is 4x Max. Working Pressure at 73°F (23°C)

Pressure ratings based on 73°F (23°C)

Decrease working pressure 1% for every 2°F above 212°F

Fittings

PAGE Fittings - pg. E-48

Uses crimp collar ST300, see pg. E-49

For most Parker products, Crimp Die Selection charts can be found online at www.parker.com/crimpsource

Access instructions are on pg. G-14

Notes

- "Z" indicates double braid
- See pg. A-21 for part numbering system
- Cannot be used with 90 or 91N series fittings



WARNING

This product can expose you to chemicals including Tetrafluoroethylene, which is known to the State of California to cause cancer. For more information go to www.P65Warnings.ca.gov.

SCW/SCB - Convuluted PTFE Hose

316 Stainless Steel Braid



Features

- High temperature hose
- Excellent corrosion resistance
- Seamless
- Open pitch
- Self draining
- Environmentally safe; low effusion

Compliances

- FDA 21 CFR 177.1550 (Natural tube)
- USP Class VI
- ISO 10993 Sections 5, 6, 10, 11

Applications/Markets

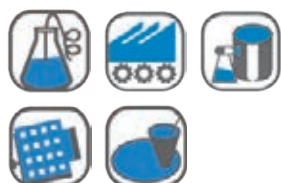

- Fluid Handling
- Chemical Transfer
- Semiconductor

[Visit the webpage](#)

Part Number		Nominal I.D.		Nominal O.D.		Maximum Working Pressure 73°F/ 23°C		Minimum Bend Radius		Vac. Rating Hg./73°F	Weight		Permanent Fitting Series
#	#	⊙		⊙		↗		↘		U	lbs	kg	⊕
Natural	Static-Dissipative	inch	mm	inch	mm	psi	bar	inch	mm	inch	lbs./ft.	kg./mtr.	
04-SCW	04-SCB	1/4	6.4	.46	11.7	1,500	104	0.75	19	28	.08	.11	PAGE
06-SCW	06-SCB	3/8	9.5	.54	13.7	1,500	104	1	25	28	.14	.21	PAGE
08-SCW	08-SCB	1/2	12.7	.72	18.3	1,500	104	1.50	38	28	.16	.23	PAGE
12-SCW	12-SCB	3/4	19.1	1.02	25.9	1,200	83	2	51	28	.27	.40	PAGE
16-SCW	16-SCB	1	25.4	1.31	33.3	1,000	69	2.50	64	28	.37	.55	PAGE
20-SCW	20-SCB	1-1/4	31.8	1.73	43.9	750	52	3	76	28	.46	.68	PAGE
24-SCW	24-SCB	1-1/2	38.1	1.93	49.0	650	45	3.75	95	28	.55	.81	PAGE
32-SCW	32-SCB	2	50.8	2.42	61.5	450	31	4.75	121	28	.90	1.4	PAGE

Construction

Tube: SCW - Natural FDA Compliant PTFE
 SCB - Black Static-Dissipative PTFE

Reinforcement: 316 Stainless Steel Braid

Operating Parameters

Temperature Range:

- -100°F (-73°C) to +500°F (260°C)

Change in length at Max. Working Pressure: +2% to -4%

Min. Burst Pressure is 4x Max. Working Pressure at 73°F (23°C)

Pressure ratings based on 73°F (23°C)

Decrease working pressure 1% for every 2°F above 212°F

Fittings

PAGE Fittings - pg. E-48

Uses crimp collar SC300, see pg. E-49

For most Parker products, Crimp Die Selection charts can be found online at www.parker.com/crimpsource

Access instructions are on pg. G-14

Notes

- See pg. A-21 for part numbering system
- Cannot be used with 93N series fittings



WARNING

This product can expose you to chemicals including Tetrafluoroethylene, which is known to the State of California to cause cancer. For more information go to www.P65Warnings.ca.gov.

SCWV/SCBV

Stainless Steel Braid, Heavy Wall Convuluted PTFE Hose



Features

- Thicker wall
- Handles vacuum applications at elevated temperatures
- Flare-Seal fittings - Continuous PTFE through the fitting, no area for material entrapment and increased flow
- Excellent chemical compatibility
- Easy Cleaning



Flare-Seal

Applications/Markets



- Fluid Handling
- Chemical Transfer
- Semiconductor
- Food & Beverage (Flare-Seal)

Compliances

- FDA 21 CFR 177.1550 (Natural tube)
- USP Class VI
- ISO 10993 Sections 5, 6, 10, 11

[Visit the webpage](#)

Part Number		Nominal I.D.		Nominal O.D.		Maximum Working Pressure 73°F/ 23°C		Minimum Bend Radius		Vac. Rating Hg./73°F	Weight	
#	#	⊙		⊙		↗		↘		U	lbs	kg
Natural	Static-Dissipative	inch	mm	inch	mm	psi	bar	inch	mm	inch	lbs./ft.	kg./mtr.
08-SCWV	08-SCBV	1/2	12.7	.75	19.1	1,500	104	2	51	28	.17	.26
12-SCWV	12-SCBV	3/4	19.1	1.04	26.4	1,200	83	2.75	70	28	.33	.49
16-SCWV	16-SCBV	1	25.4	1.25	31.8	1,000	69	4	102	28	.37	.55
20-SCWV	20-SCBV	1-1/4	31.8	1.66	42.2	750	52	5.50	140	28	.56	.83
24-SCWV	24-SCBV	1-1/2	38.1	1.92	48.8	650	45	7	178	28	.64	.95
32-SCWV	32-SCBV	2	50.8	2.49	63.2	450	31	8.50	216	28	.84	1.24
40-SCWV*	40-SCBV*	2-1/2	63.5	3.25	82.6	200	14	12	305	28	1.52	2.26
48-SCWV*	48-SCBV*	3	76.2	3.80	96.5	175	12	14	356	28	1.82	2.71
64-SCWV*	64-SCBV*	4	101.6	4.76	120.9	150	10	16	406	28	2.10	3.13

Construction

Tube: SCWV - Natural FDA Compliant PTFE
SCBV - Black Static-Dissipative PTFE

Reinforcement: 316 Stainless Steel Braid

Operating Parameters

Temperature Range:

- -100°F (-73°C) to +500°F (260°C)

Change in length at Max. Working Pressure: +2% to -4%

Min. Burst Pressure is 4x Max. Working Pressure at 73°F (23°C)

Pressure ratings based on 73°F (23°C)

Decrease working pressure 1% for every 2°F above 212°F

Fittings

PAGE Fittings - pg. E-48

Notes

- Factory-made assemblies only
- See pg. A-21 for part numbering system

Cannot be used with 93N Series Fittings

- *Vacuum wire recommended to achieve 28 inch rating



WARNING

This product can expose you to chemicals including Tetrafluoroethylene, which is known to the State of California to cause cancer. For more information go to www.P65Warnings.ca.gov.

NCW/NCB - Seamless Convoluted PTFE with Nomex® Braid

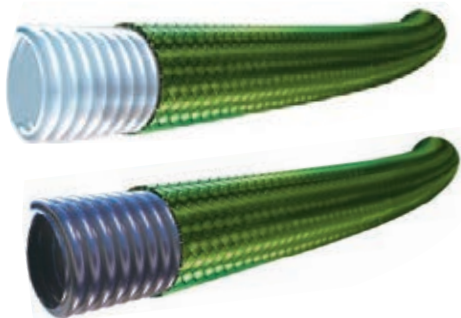

Features

- Very light weight
- Superior flexibility
- Kink and vacuum resistant
- Eliminates RFI issues

Compliances

- FDA21 CFR 177.1550 (Natural tube)
- USP Class VI
- ISO 10993 Sections 5, 6, 10, 11

Applications/Markets



- Fluid Handling
- Chemical Transfer
- Paint
- Pharmaceutical
- Food & Beverage
- Cosmetics

[Visit the webpage](#)

Part Number		Nominal I.D.		Nominal O.D.		Maximum Working Pressure 73°F/ 23°C		Minimum Bend Radius		Vac. Rating Hg./73°F	Weight	
#	#											
Natural	Static-Dissipative	inch	mm	inch	mm	psi	bar	inch	mm	inch	lbs./ft.	kg./mtr.
04-NCW	04-NCB	.260	6.6	.460	11.7	725	50	1	25	28	.02	.03
06-NCW	06-NCB	.370	9.4	.560	14.2	400	28	1-1/2	38	28	.06	.09
08-NCW	08-NCB	.500	12.7	.740	18.8	280	19	2	51	28	.08	.12
12-NCW	12-NCB	.750	19.1	1.010	25.7	200	14	2-1/2	64	28	.14	.22
16-NCW	16-NCB	1.000	25.4	1.290	32.8	200	14	4	102	28	.22	.32

Construction

Tube: NCW - Natural PTFE
NCB - Black Static Dissipative PTFE

Reinforcement: Nomex® braid

Operating Parameters

Temperature Range:

- -100°F (-73°C) to +400°F (204°C)

Change in length at Max. Working Pressure: +2% to -4%

Min. Burst Pressure is 4x Max. Working Pressure at 73°F (23°C)

Pressure ratings based on 73°F (23°C)

Decrease working pressure 1% for every 2°F above 212°F

Fittings

PAGE Fittings - pg. E-48

Notes

- Factory-made assemblies only
- NCB (Static Dissipative) tube I.D. surface only
- NCB Conductive Spec - Must conduct 20 microamps 1000 VDC potential 14" sample
- See pg. A-21 for part numbering system
- Cannot be used with 93N series fittings



Nomex® is a registered trademark of E. I. du Pont de Nemours and Company.



WARNING

This product can expose you to chemicals including Tetrafluoroethylene, which is known to the State of California to cause cancer. For more information go to www.P65Warnings.ca.gov.

Metal Hose 9A, 9M, 9P

See **CATALOG 4690MH** for technical information

Features:

- Hydroformed annular core tube
- High percentage braid coverage for better life cycle and protection against core damage
- 9A - General Purpose - up to 2,700 psi working pressures
- 9M - Ultra Flexible - Compressed corrugations for increased flexibility, up to 2,700 psi working pressure
- 9P - High Pressure - up to 6,000 psi working pressure, Parker's highest pressure metal hose construction



Applications/Markets



- Abrasion and over bending - as a protective cover over wires or other hoses to prevent these problems
- Chemical transfer
- Diesel engine exhaust
- Hot oil and lube lines
- Loading/unloading of light oils, gas, and chemicals
- Petrochemical
- Power Gen
 - Connections for the fuel rail to the combustion cans on gas turbine fuel lines
 - Pump connections
- Pulp & Paper
- Solvent and steam lines

Metal Hose Size and Performance Specifications			
Inside Diameter (in.)	9A	9M	9P
1/4	•	•	•
3/8	•	•	•
1/2	•	•	•
5/8	•	•	•
3/4	•	•	•
1	•	•	•
1-1/4	•	•	•
1-1/2	•	•	•
2	•	•	•
2-1/2	•	•	•
3	•	•	•
4	•	•	•
5	•	•	•
6	•	•	•

For sizes larger than 6", contact customer service.

Construction

Tube: 300 series SS

Reinforcement: 300 series SS braid: 0, 1 or 2 layers

Operating Parameters

Temperature Range:

-380°F (-228°C) to +1200°F (+648°C)

Working Pressure

Reference individual pages and derating charts in CAT 4690MH

For technical information,
download CAT 4690



See **CATALOG 4690MH** for technical information

Multitube® BOP Bundles, Electro-Hydraulic Umbilicals and Hotlines



Features:

- Dependability and Experience - Over 30 years of Oil & Gas thermoplastic hose design and engineering experience
- Field Tested - Over 750,000 feet of bundles and over 40 million feet of pilot hose produced for rigs
- Capabilities - BOP umbilical lengths up to 7,000+ ft and 90+ pilot hoses within 1 umbilical
- Extended Service Life - Compact pilot hose design allows for more spares to be installed in the bundle without increasing the O.D.

Applications/Markets



- Oil & Gas

For technical information, contact customer services



BOP Umbilicals with Velocity Hose

Parker offers premier hose solutions for every aspect of hydraulic BOP controls. Parker's BOP umbilicals are used on offshore drilling rigs to control the subsea BOP stack. They have a smaller O.D. which means Parker can produce BOP umbilicals with more pilot lines without increasing the O.D. of the umbilical. The umbilical is built with Velocity Hose to allow for precise control and faster response times when activating subsea valves on the BOP pod.



Electro-Hydraulic Umbilicals

Parker is an industry leader in designing short length electro-hydraulic umbilicals for offshore applications. We also produce high-pressure subsea hoses, (1/4", 3/8" and 1/2" I.D.) in compliance to API 17e and pressure ratings up to 15,000 psi. These hoses can be combined into an umbilical configuration with electrical power cables included.



Hotline Hose

Subsea Hotline's are the primary emergency hydraulic control line providing critical service for various subsea functions. Parker Hotline hoses are specially designed to provide fast response time and low volumetric expansion with length capability of 14,000 feet continuous.

A redundant jacket option is available for additional abrasion resistance and protection.

These hoses are custom engineered. For technical information, contact customer service.



A Hose

B Tubing

C Coiled Air Hose & Fittings

D Transportation

E Fittings

F Tooling, Equipment & Accessories

G General Technical

polyflex Ultra-High Pressure Hose

See CATALOG 4900 for technical information



Features:

- Working pressures up to 58,000 psi
- Wide range of hose sizes from 5/64" to 3" I.D.
- Very long continuous lengths available
- Multiple color options for ease of identification
- Wide range of core tube and jacket material options available

Applications/Markets



- Oil & Gas
- Water Blast/Water Jetting
- Hydraulic Tool



Oil & Gas Hose

With production plants in both the USA and Europe, supported by Parker's global sales and distribution network, customers can benefit from local service and the supply of quality parts wherever they are situated. **polyflex** oil & Gas hoses are used in a wide variety of Oil & Gas applications, both onshore and offshore, and are available with seawater resistant cover materials.



Water Blast Hose

polyflex Water Blast Hoses are the highest quality ultra high pressure thermoplastic hoses on the market and are also ideal for construction applications such as hydrodemolition, industrial cleaning and surface preparation.



Hydraulic Tool Hose

polyflex HP hoses can be used to power hydraulic tools, such as torque wrenches and bolt tensioners. They are also used on rescue equipment such as the Jaws of Life and similar tools.

For technical information,
download CAT 4900



See CATALOG 4900 for technical information

Thermoplastic

Polyethylene

Nylon

Polypropylene

Polyurethane

Clear Vinyl

Fluoropolymer

PTFE

FEP

PFA



Table of Contents

Thermoplastic Tubing

Introduction

Intro.....	B-4
Tubing Compatibility Chart for Fittings	B-8

Polyethylene Tubing

Fractional – Series E/EB.....	B-12
Metric – Series E/EB.....	B-14
Flame Resistant – Series PEFR.....	B-16
High Density – Series HDPE	B-18

Nylon Tubing

Fractional – Series N/NB.....	B-20
Metric – Series N/NB.....	B-22
Pure Air Tubing – Series PAT	B-24
Semi-rigid Tubing – Series NR	B-26

Polypropylene Tubing

Laboratory Grade – Series PP/PPB.....	B-28
---------------------------------------	------

Polyurethane Tubing

Fractional Polyether Base – Series U.....	B-30
Metric Polyether Base – Series UM.....	B-32
Fractional – Series HU.....	B-34
Metric – Series HUM.....	B-36
MicroWeld™ Flame Resistant - Series 95FR	B-38

Clear Vinyl Tubing

Clear Vinyl Tubing – Series PV.....	B-40
-------------------------------------	------

Fluoropolymer Tubing

Introduction

Intro, Material Overview.....	B-44
Resin Comparison.....	B-47
Fluoropolymer Nomenclature	B-48

PTFE Tubing

Fractional – Series 101	B-50
Metric – Series 201	B-50
Fractional – Series TFS, TFT, TFL	B-54
AWG – Series TFH, TFS, TFT, TFL.....	B-56
Spiral Cut Cable Wrap, TSWTF	B-60
PTFE Fractional Heat Shrink - Series HS2TFS, HS2TFT, HS2TFL, HS2TFI	B-62
PTFE AWG 2:1 Heat Shrink - Series HS2TFS, HS2TFT, HS2TFL.....	B-64
PTFE AWG 4:1 Heat Shrink - Series HS4TFI	B-68
Convolute, Convo-Tex® - Series CV.....	B-70
Low Profile, Heavy Wall - Series CVL, CVH	B-72
AMS-T-81914/1 and 2 - Series 81914.....	B-74

FEP Tubing

Fractional – Series 103	B-76
Metric – Series 203	B-76
FEP 1.3:1 Heat Shrink - Series HS1.3FEP	B-78
FEP 1.67:1 Heat Shrink - Series HS1.67FEP	B-80
FEP Roll Cover - Series HS1.25FEP	B-82
Convolute- Series CV03; AMS-T-81914/3 and 4 - Series 81914.....	B-84
Corrugated - Series CR03.....	B-86
Retractable Coiled Tubing- Series 703.....	B-88

PFA Tubing

Fractional – Series 104	B-90
Metric – Series 204	B-90

High Purity PFA Tubing

Fractional – Series 105	B-92
Metric – Series 205	B-92

Parflex Tubing Introduction

Parflex EZ Pack Tubing



Retail Packaging

EZ Pack 100 foot boxes are now available for Nylon and Polyurethane tubing in some sizes. Designed for easy storage and easy dispensing, these boxes are excellent for retail sales and fulfilling small quantity requirements.

Parflex Tubing Tutorial

- Review the general attributes of Parflex thermoplastic and fluoropolymer tubing – this provides an excellent overview for the tubing product line.
- Review the application symbols - this will help you clear up any questions you may have on the product tables within the section. The market/applications table identifies and provides a “good fit” summary.
- Review the pressure bar graph - provides relative pressure ratings for the entire line of thermoplastic tubing. For fluoropolymer tubing, please contact Customer Service.
- Review the STAMPED guide (Size, Temperature, Media, Application, Pressure, End Configuration, and Delivery Preferences) on pg. 13 to help narrow your search for the desired product.
- Specific nomenclature, features, advantages and benefits can be found at the beginning page of each product line.
- Text appears in 2 colors. The primary dimensions are in black. As a courtesy, the metric/inch equivalent has been added and appears in blue.

Tubing Introduction

Tube Line Fabrication Guide for Leak Free Systems

Every hydraulic, pneumatic and lubrication system requires some form of tube line fabrication and fitting installation for completion. Proper fabrication and installation are essential for the overall efficiency, leak free performance and general appearance of any system.

Start by planning ahead. After sizing the tube lines and selecting the appropriate style of fitting, consider the following in the design of your system:

- Accessibility of joints
- Proper routing of lines
- Adequate tube line supports
- Available fabricating tools

Routing of Lines

Routing of lines is probably the most difficult, yet most significant, of these system design considerations. Proper routing involves getting a connecting line from one point to another through the most logical path.

Always try to leave fitting joints as accessible as possible. Hard to reach joints are hard to assemble and tighten properly. Inaccessible joints are also more difficult and time consuming to service.

Applications/Markets



Fluid Handling



Construction



Transportation



Industrial Pneumatic



Electrical



Military



General Industrial



Compressed Gas



Medical



Semiconductor



Food & Beverage



Pharmaceutical

Multitube® Tubing Introduction

See CAT 4200 for technical information

The Multitube® instrumentation product line has produced thermal insulated and heat traced tubing for over 40 years. Tubing and tubing bundles transfer gas, fluids, steam and viscous materials through instrument lines, condensate return lines, cooling water lines, lubrication lines and refrigeration lines. Some of these products are available with heated elements to ensure maximum freeze protection during the winter. The products displayed on these pages are just a sampling of the types of products available in the Multitube line of products. See Catalog 4200 for a detailed review.



Applications/Markets



- Chemical Processing
- Refineries
- Oil & Gas
- Power Generation



MJ - Jacketed Metal Tubing

Bundled tubing is an ideal alternative for applications where multiple lengths of tubing are currently being installed independently. Manufactured with or without protective, galvanized steel armor and a protective outer jacket. Metal tubes are uniquely identified using a number code printed along the entire length of each tube.

MJ - Metal, Jacketed MA - Metal Armored MAJ - Metal, Armor, Jacketed



PJ - Jacketed Plastic Tubing

Bundled tubing is an ideal alternative for applications where multiple lengths of tubing are currently being installed independently. Manufactured with or without protective, galvanized steel armor and a protective outer jacket. Plastic tubes are uniquely identified using a number code printed along the entire length of each tube.

PJ - Plastic, Jacketed PA - Plastic Armored PAJ - Plastic, Armor, Jacketed



TT - Temptube® Preinsulated Tubing

Preinsulated tubing - Transfer of fluids or gases up to 400°F while maintaining an outer jacket surface temperature of 140°F. Insulated bundles rated up to 1200°F. Also available as a custom bundle.

Typically used in steam supply lines, condensate return lines, cooling water lines, lubrication lines, refrigeration lines and liquid nitrogen lines.



LT - Light Steam Trace

Temprace® LT - Permits use of higher pressure steam to heat trace instrument lines. Single or multiple tubes designed to utilize saturated steam pressures to 230 PSIG (15.8 BAR) and 400°F without generating a process tube temperature in excess of 200°F or a jacket surface temperature greater than 140°F.



SL - Self Regulating Low Temperature Maintenance Bundles

Temprace® SL - Maintain temperatures up to 150°F and withstands maximum internal exposure to 185°F. Designed to provide freeze protection and low temp. maintenance for gases, liquids or viscous materials. With outdoor temperatures of -40°F, SL-Temprace™ will maintain a process fluid or gas at 40°F to 400°F while maintaining an outer jacket surface temp. of 140°F. Heated cables are available in 120V and 208-277 volt, with heat outputs of 3, 5, 8 and 10 watt/ft.



SH - Self Regulating High Temperature Maintenance Bundles

Temprace® SH - Maintain temperatures up to 250°F and withstands an internal exposure temp. of 400°F. Designed to provide temp. maintenance for gases, liquids or other process materials. Has a max. temp. rating of 250°F (121.1°C), when power to the heating cable is on, and can be steam cleaned at 400°F (204°C), when power to the heating cable is off.



For technical information, download CAT 4200

Tubing Compatibility Chart for Fittings

Tubing Compatibility Chart

Parker Tubing / Hose Capability with Parker FSC Fittings

Parflex
Thermoplastic and Thermo-elastomer Tubing

Industrial Tubing Series (Outside Diameter (O.D.) Shown)

Product Sizes (inch)		Polyethylene E & EB Inch (4.5, 6.8, 10) Metric (6.8, 10, 12)	Polyethylene PEFR Inch (2.5, 4, 6.8)	Polyethylene HDPE Inch (4, 6)	Nylon N Inch (2.2, 5, 3, 4, 5, 6, 8)	Nylon PAT Inch (2.4, 6, 8, 10, 12)	Nylon NR Inch (2, 3, 4, 5, 6, 8)	Polypropylene PP & PPB Inch (2.2, 5, 3, 4, 6, 8, 10)	Polyurethane U & UM (90 - 95 Shore A) Inch (2.3, 4, 6, 8, 9, 12) Metric (4, 6, 8, 10, 12)	Polyurethane HU & HUM (>95 Shore A) Inch (2.2, 5, 4, 6, 8, 12) Metric (4, 6, 8, 10, 12)	Polyurethane MicroWeld™ 95FR Inch (4, 6, 8) Metric (6, 8, 10, 12)	Clear Vinyl Inch (1/8" - 2 1/2")
Compression & Flare	Compression Inch (2,3,4,5,6,7,8,10,12)	PS TS	PS TS	PS TS	PS TS	PS TS	PS TS	PS TS				
	Compress-Align Inch (2,3,4,5,6,8,10,12,14,16)	TS	TS	TS	TS	TS	TS	TS				
	Metric Compression Metric (4.5, 6.8, 10, 12, 14, 16, 18, 20, 22, 25, 28)	TS			TS		TS	TS		TS		
	Poly-Tite Inch (4, 5, 6, 8)				BS			BS				
	Hi-Duty Inch (2, 3, 4, 5, 6, 8, 10)	TS	TS	TS	TS	TS	TS	TS				
	45 degree flare Inch (2, 3, 4, 5, 6, 8, 10, 12, 14)											
	Inverted Flare Inch (2, 3, 4, 5, 6, 8, 10, 12)											
	Fast & Tite Inch (4, 5, 6, 8, 10)								TS	TS		TS
	Flow Controls Inch (2.2, 5, 4, 5, 6, 8) Metric (4, 6, 8, 10, 12)											
	Prestolok Brass Inch (2.2, 5, 3, 4, 5, 6, 8)											
Push-to-Connect	Prestolok Composite Inch (2.2, 5, 3, 4, 5, 6, 8, 10) Metric (3, 4, 6, 8, 10, 12, 14, 16)											
	Prestolok All-Metal Inch (2.5, 4, 5, 6, 8) Metric (4, 6, 8, 10, 12, 14)											
	Prestolok Stainless Inch (2.5, 3, 4, 5, 6, 8) Metric (4, 6, 8, 10, 12)											
	Liquifit Inch (2.5, 4, 6, 8) Metric (4, 6, 8, 10, 12)											
	TrueSeal Inch (4, 5, 6, 8)						MG		TS	TS		TS
Barb	Par-Barb Inch (2, 3, 4, 5, 6, 8, 10, 12, 16, 20, 24) Inside Diameter								CL			CL
	Dubl-Barb Inch (2.5, 4, 6, 8)											
	Hose Barb Inch (2, 3, 4, 5, 6, 8, 10, 12, 16) Inside Diameter											CL
	Garden Hose											CL
DOT Transportation	NTA Inch (3, 4, 6, 8, 10, 12)											
	Transmission Fittings Inch (2.2, 5)											
	Air Brake Inch (4, 6, 8, 10, 12, 16)											
	Air Brake Hose Inch (6, 8)											
	Vibra-Lok Inch (2, 3, 4, 5, 6, 8, 10, 12)											
General Technical	Prestomatic Inch (4, 6, 8, 10) Metric (6, 8, 10, 12, 16)											
	PTC Inch (2.5, 3, 4, 6, 8, 10, 12)											
	SAE Cartridges Inch (4, 6, 8, 10)											

Tube Line Fabrication Guide for Leak Free Systems

Every hydraulic, pneumatic and lubrication system requires some form of tube line fabrication and fitting installation for completion. Proper fabrication and installation are essential for the overall efficiency, leak free performance, and general appearance of any system.

Start by planning ahead. After sizing the tube lines and selecting the appropriate style of fitting, consider the following in the design of your system:

1. Accessibility of joints
2. Proper routing of lines
3. Adequate tube line supports
4. Available fabricating tools

Parflex Thermoplastic Tubing				Parflex Fluoropolymer Tubing			Product Sizes (inch)	
Transportation Tubing				PFA Fluoropolymer Inch (3/32" - 1") Metric (4mm - 12mm)	FEP Fluoropolymer Inch (1/8" - 1") Metric (3mm - 12mm)	PTFE Fluoropolymer Inch (3/32" - 1") Metric (3mm - 16mm)		
PFT Air Brake (SAE J844) Inch (2,2.5,3,4,5,6,8,10,12)	Air Brake DIN 74324 (Nylon 12) Metric (4,6,8,10,12,15,16,18)	PFT Diesel Fuel Sizes 4, 6, 8, 10, 12	HTFL Diesel Fuel Sizes 4, 6, 8, 10, 12					
				PS	PS	PS	Compression Inch (2,3,4,5,6,7,8,10,12)	Compression & Flare
				TS	TS	TS	Compress-Align Inch (2,3,4,5,6,8,10,12,14,16)	
				TS	TS	TS	Metric Compression Metric (4,5,6,8,10,12,14,16,18,20,22,25,28)	
							Poly-Tite Inch (4,5,6,8)	Push-to-Connect
							Hi-Duty Inch (2,3,4,5,6,8,10)	
							45 degree flare Inch (2,3,4,5,6,8,10,12)	
							Inverted Flare Inch (2,3,4,5,6,8,10,12,14)	
							Fast & Tite Inch (4,5,6,8,10)	
							Flow Controls Inch (2,2.5,4,5,6,8) Metric (4,6,8,10,12)	Barb
							Prestolok Brass Inch (2,2.5,3,4,5,6,8)	
							Prestolok Composite Inch (2,2.5,3,4,5,6,8, 10) Metric (3,4,6,8,10,12,14,16)	
							Prestolok All-Metal Inch (2.5,4,5,6,8) Metric (4,6,8,10,12,14)	
							Prestolok Stainless Inch (2.5,3,4,5,6,8) Metric (4,6,8,10,12)	DOT Transportation
							Liquifit Inch (2.5,4,6,8) Metric (4,6,8,10,12)	
				MG	MG	MG	TrueSeal Inch (4,5,6,8)	
							Par-Barb Inch (2,3,4,5,6,8,10,12,16,20,24) Inside Diameter	DOT Transportation
							Dubl-Barb Inch (2,5,4,6,8)	
							Hose Barb Inch (2,3,4,5,6,8,10,12,16) Inside Diameter	DOT Transportation
							Garden Hose	
							NTA Inch (3,4,6,8,10,12)	DOT Transportation
							Transmission Fittings Inch (2,2.5)	
	TS						Air Brake Inch (4,6,8,10,12,16)	DOT Transportation
							Air Brake Hose Inch (6,8)	
							Vibra-Lok Inch (2,3,4,5,6,8,10,12)	DOT Transportation
							Prestomatic Inch (4,6,8,10) Metric (6,8,10,12,16)	
							PTC Inch (2,5,3,4,6,8,10,12)	
							SAE Cartridges Inch (4,6,8,10)	

PS Plastic Sleeve & Tube Support Recommended

TS Tube Support Is Recommended

BS Brass Sleeve Recommended

CL Clamp Required

MG Metal Gripper Collet Recommended

MG Tube/Fitting Combination Compatible

MG Tube/Fitting Combination NOT Compatible

For technical information, download FSC CAT 3501



Thermoplastic Tubing

Polyethylene

- Parflex polyethylene tubing meets FDA, NSF Standard 51 for all food contact applications and NSF-61 for potable water applications.
- E-Series NSF tubing is made of 100% virgin resin material.
- Polyethylene tubing meets ASTM D-1693 (10% IGEPAL) for stress crack resistance.
- Parflex also offers special PE tubing: PEFR (flame retardant) and HDPE (high density).

Nylon

- Flexible nylon tubing is constructed of high-grade resins for strength and flexibility for routing in tight spaces.
- Semi-rigid high strength nylon is constructed of high-grade resins without the addition of plasticizers for higher pressure tubing applications.
- Pure Air Tubing (PAT) is the tubing choice for pure air systems (semiconductor) due to its cleanliness; in addition, it offers excellent chemical and UV light resistance.

Polypropylene

- Polypropylene tubing meets FDA, NSF Standard 51 for all food contact applications.
- Polypropylene tubing exhibits excellent chemical resistance to chlorinated water applications.
- Black Polypropylene tubing is commonly used in outdoor applications where UV light stabilization is required.

Polyurethane

- Polyurethane tubing is a flexible, kink-resistant and abrasion-resistant material commonly used in pneumatic applications.
- Polyurethane is available in multiple transparent and opaque colors for system color coding.
- Weld spatter resistant tubing for air and water supply lines
- Polyurethane is available in the following durometers (measurement of material hardness):
Medium durometer: (90 – 95)
High durometer: (>95) for higher pressures

Polyvinyl Chloride (PVC)

- PVC tubing is made from 100% virgin resin material and meets all FDA specifications for materials in contact with food and drugs.
- PVC tubing is a very flexible, 70 durometer tubing. It is crystal-clear and ideal for situations where visible fluid flow is necessary (i.e. sight gauges for tank identification).

All plastic tubing dimensions are laser monitored to ensure overall quality product.
Most tubing sizes are packaged in convenient 100-ft., 250-ft., 500-ft. and 1,000-ft. lengths.

Typical Applications

Product Family	Series	Suggested Markets and Applications
Polyethylene	E and EB	Potable water, chemical transfer, and low-cost, low-pressure pneumatics, NSF-51 & NSF- 61
	PEFR	Pneumatic controls in HVAC
	HDPE	Chemical transfer and low-cost pneumatics
Nylon	N	Pneumatic and petroleum-based chemical transfer
	PAT	Pure air and gas distribution systems, semiconductor
	NR	High pressure pneumatic, low pressure lubrication and hydraulic, marine control systems
Polypropylene	PP and PPB	Food contact and chemical transfer applications, chlorinated water
Urethane	U and UM	Pneumatic controls requiring high flexibility, kink resistance and movement
	HU and HUM	High-pressure pneumatics requiring flexibility and kink resistance, robotics
	95FR	Low to medium pressure air and water supply lines where weld spatter protection is needed
Vinyl	PV	Low-pressure chemical and medical applications requiring high clarity and flexibility, FDA

Tubing Pressure Ranges

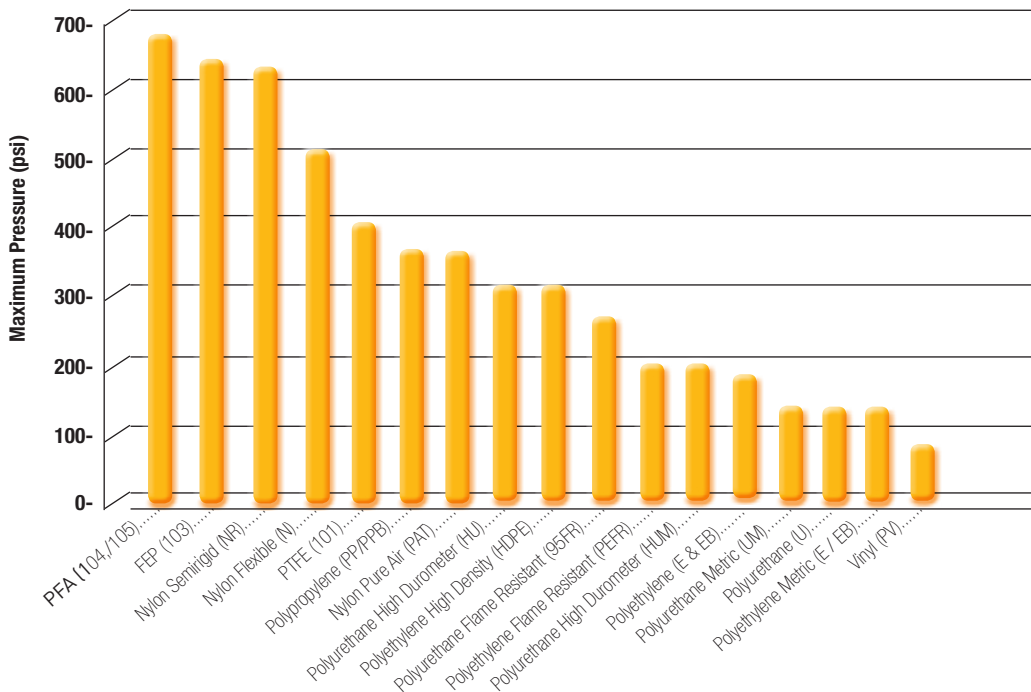

Working pressures are at 73°F (23°C). Pressure ratings are also effected by diameter of tubing and wall thickness. Actual performance may vary with different media and working conditions. Use this information for comparison only.

Polyethylene Tubing

Series E: Instrument Grade – FDA, NSF Listed
 Series EB: Ultraviolet Light Resistant



Features

- Made from 100% virgin resin material
- Chemically resistant and flexible
- High molecular weight resin provides increased dimensional stability, uniformity and long-term strength
- Economical system solution

Certifications/Compliance

- FDA compliant for food contact
- ASTM D-1693 (10% IGEPAL) for stress crack resistance
- NSF - 51
- NSF - 61

Applications/Markets



- Potable water
- Chemical transfer
- Low-pressure pneumatics



Part Number	Part Number	Tube O.D.		Tube I.D.		Average Wall Thickness		Working Pressure at 73°F / 23°C		Minimum Burst at 73°F / 23°C		Package Quantity	Minimum Bend Radius		Weight	
		inch	mm	inch	mm	inch	mm	psi	bar	psi	bar		inch	mm	lbs./ft.	kg./mtr.
#	#															
Natural	Black	inch	mm	inch	mm	inch	mm	psi	bar	psi	bar		inch	mm	lbs./ft.	kg./mtr.
E-43-XXXX	EB-43-XXXX	1/4	6.4	.170	4.3	.040	1.0	120	8.3	480	33.1	Package quantities vary by size and color	1.00	25.4	.011	.016
E-53-XXXX	EB-53-XXXX	5/16	7.9	.187	4.8	.062	1.6	145	10.0	580	40.0		1.13	28.7	.020	.030
E-64-XXXX	EB-64-XXXX	3/8	9.5	.250	6.4	.062	1.6	125	8.6	500	34.5		1.25	31.8	.025	.037
E-86-XXXX	EB-86-XXXX	1/2	12.7	.375	9.5	.062	1.6	90	6.2	360	24.8		2.50	63.5	.034	.051
E-108-XXXX	EB-108-XXXX	5/8	15.9	.500	12.7	.062	1.6	70	4.8	280	19.3		4.00	101.6	.044	.065

Standard black is not FDA or NSF approved.



WARNING

This product can expose you to chemicals including Titanium dioxide, which is known to the State of California to cause cancer. For more information go to www.P65Warnings.ca.gov.

Order Information

Example: E-64-Y-0500

E-64-Y-0500 – Polyethylene

E-64-Y-0500 – **Tube O.D.** in sixteenths of an inch (**3/8"**)

E-64-Y-0500 – **Tube I.D.** in sixteenths of an inch (**.250"**)

E-64-Y-0500 – **Color**, i.e. **Yellow** (Omit for Natural and Black)

E-64-0500 – Natural Polyethylene

EB-64-0500 – Black Polyethylene

E-64-Y-0500 – **Package Quantity** in feet (**500'**)

Available in black as well as nine other colors, as suggested by the Instrument Society of America

Color Code		
●	-	Natural
●	-	Black
●	B	Blue
●	G	Green
●	O	Orange
●	P	Purple
●	R	Red
●	GRA	Gray
●	Y	Yellow
○	WHT	White

Polyethylene Tubing (Series E)

Maximum Working Pressure (psig)

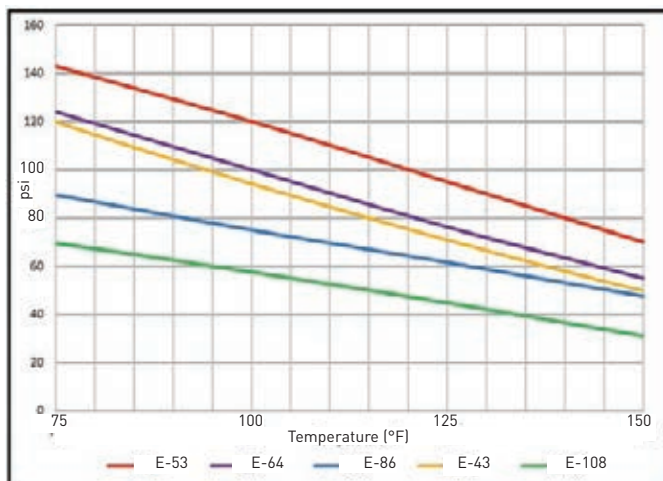

WARNING

This product can expose you to chemicals including Titanium dioxide, which is known to the State of California to cause cancer. For more information go to www.P65Warnings.ca.gov.

Fittings

Parker fittings available from:
Fluid System Connectors Division
Otsego, MI
(269) 692-6555
(269) 694-4614 FAX

FSC Product Families:

- Compression
- Compress-Align®
- Poly-Tite
- Hi-Duty
- Fast & Tite
- Flow Controls
- Prestolok Brass
- Prestolok Composite
- Prestolok Stainless
- Prestolok All-Metal
- Liquifit
- TrueSeal™
- Dubl-Barb®

For tube support use, reference Tubing/Fitting Compatibility Chart (pg. B-8/B-9) or contact Fluid System Connectors Division (269) 692-6555.

Notes

- E series natural and colored tubing meet FDA, NSF-51 requirements for food contact applications and NSF-61 for potable water
- FDA, NSF-51 and NSF-61 compliant black polyethylene tubing is also available. Add -NSF suffix to the EB part number (ie. EB-64-0500-NSF)
- Resistant to environmental stress cracking exceeding that of ordinary polyethylene tubing as measured by ASTM D-1693 (10% IGEPAL)
- Black (EB) tubing is suggested for use in sunlit areas and in close proximity to high ultraviolet light sources
- All tubing conforms to ASTM D-1248, Type I, Class A, Category 4, Grade E5
- The operating temperature range for service at rated pressures with compatible fluids is -80°F (-62°C) to +150°F (66°C)

Colors

- See Color Code Table

Metric Polyethylene Tubing

Series E: Instrument Grade – FDA, NSF Listed
 Series EB: Ultraviolet Light Resistant

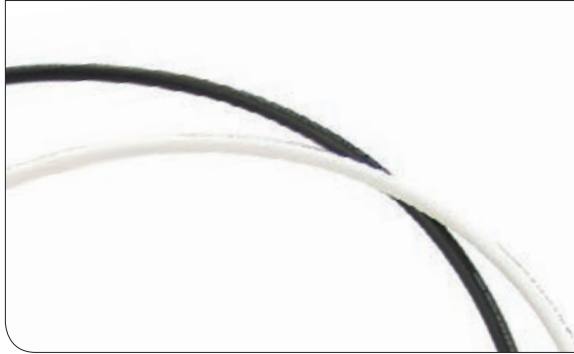

Features

- Made from 100% virgin resin material
- Chemically resistant and flexible
- High molecular weight resin provides increased dimensional stability, uniformity and long-term strength
- Economical system solution

Certifications/Compliance

- FDA compliant for food contact
- ASTM D-1693 (10% IGEPAL) for stress crack resistance
- NSF - 51
- NSF - 61

Applications/Markets



- Potable water
- Chemical transfer
- Low-pressure pneumatics



Part Number	Part Number	Tube O.D.		Tube I.D.		Average Wall Thickness		Working Pressure at 73°F / 23°C		Minimum Burst at 73°F / 23°C		Package Quantity	Minimum Bend Radius		Weight		
		mm	inch	mm	inch	mm	inch	bar	psi	bar	psi		mm	inch	kg./mtr.	lbs./ft.	
#	#																
Natural	Black																
E-6X1-0100	EB-6X1-0100	6	.236	4	.157	1.00	.039	8.6	125	34.5	500	100	25	1.00	.019	.013	
E-8X1-0100	EB-8X1-0100	8	.315	6	.236	1.00	.039	6.9	100	27.6	400	100	38	1.50	.021	.014	
E-10X1.5-0100	EB-10X1.5-0100	10	.393	7	.276	1.50	.059	8.6	125	34.5	500	100	38	1.50	.039	.026	
E-12X1.5-0100	EB-12X1.5-0100	12	.472	9	.354	1.50	.059	6.2	100	24.8	400	100	63	2.50	.048	.032	

Standard black is not FDA or NSF approved.



WARNING

This product can expose you to chemicals including Titanium dioxide, which is known to the State of California to cause cancer. For more information go to www.P65Warnings.ca.gov.

Order Information

Example: E-8x1-0100

E-8x1-0100 – Metric Polyethylene (Natural)

EB-8x1-0100 – Metric Polyethylene (Black)

E-8x1-0100 – Tube O.D. in millimeters (8 mm)

E-8x1-0100 – Tube Wall Thickness in millimeters (1 mm)

E-8x1-0100 – Package Quantity in feet (100')

Metric Polyethylene Tubing (Series E)

Maximum Working Pressure (bar)

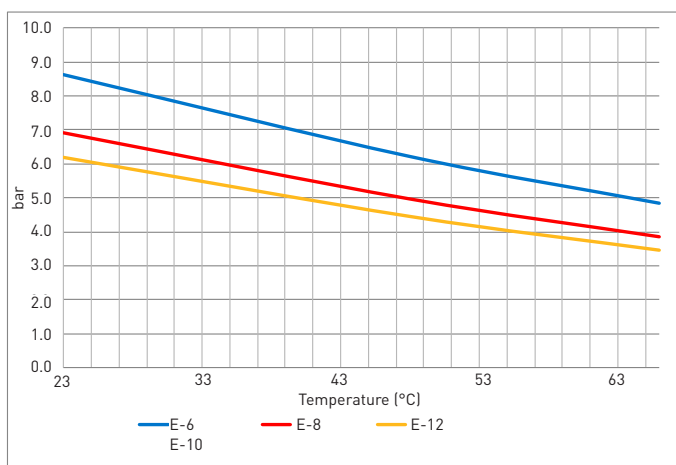

Fitting Recommendations

Parker fittings available from:
Fluid System Connectors Division
Otsego, MI
(269) 692-6555
(269) 694-4614 FAX

FSC Product Families:

- Compression Metric
- Flow Controls
- Prestolok Composite
- Prestolok All-Metal
- Prestolok Stainless
- Liquifit

For tube support use, reference Tubing/
Fitting Compatibility Chart (pg. B-8/B-9) or
contact Fluid System Connectors Division
(269) 692-6555.

Notes

- E series natural tubing listed below meet FDA, NSF-51 requirements for food contact applications and NSF-61 for potable water
- FDA, NSF-51 and NSF-61 compliant black polyethylene tubing is also available. Add -NSF suffix to the EB part number (ie. EB-64-0500-NSF)
- Resistant to environmental stress cracking exceeding that of ordinary polyethylene tubing as measured by ASTM D-1693 (10% IGEPAL)
- Black (EB) tubing is suggested for use in sunlit areas and in close proximity to high ultraviolet light sources
- All tubing conforms to ASTM D-1248, Type I, Class A, Category 4, Grade E5
- The operating temperature range for service at rated pressures with compatible fluids is -85°F (-65°C) to +150°F (66°C)

Colors

- Natural
- Black



WARNING

This product can expose you to chemicals including Titanium dioxide, which is known to the State of California to cause cancer. For more information go to www.P65Warnings.ca.gov.

Polyethylene Tubing

Series PEFR: Flame Resistant

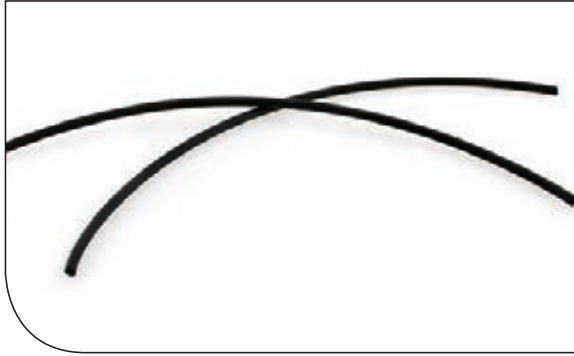

Features

- Excellent stress crack resistance

Certifications/Compliance

- UL 94 V-2
- ASTM D-1693 (10% IGEPAL) for stress crack resistance

Applications/Markets



- Pneumatic controls in HVAC applications

Part Number	Tube O.D.		Tube I.D.		Average Wall Thickness		Working Pressure at 73°F /23°C		Minimum Burst at 73°F /23°C		Package Quantity	Minimum Bend Radius		Weight	
	inch	mm	inch	mm	inch	mm	psi	bar	psi	bar		inch	mm	lbs./ft.	kg./mtr.
#															
Black	inch	mm	inch	mm	inch	mm	psi	bar	psi	bar		inch	mm	lbs./ft.	kg./mtr.
PEFR-2.5-XXXX	5/32	4.0	.096	2.4	.030	0.76	185	12.8	740	51.0	Package quantities vary by size and color	.50	12.7	.006	.009
PEFR-4-XXXX	1/4	6.4	.170	4.3	.040	1.0	140	9.7	560	38.6		.75	17.4	.012	.018
PEFR-6-XXXX	3/8	9.5	.250	6.4	.062	1.6	155	10.7	620	42.8		1.50	36.1	.029	.043
PEFR-8-XXXX	1/2	12.7	.375	9.5	.062	1.6	100	6.9	400	27.6		1.75	39.1	.041	.061



WARNING

This product can expose you to chemicals including Antimony Oxide (Antimony Trioxide), which is known to the State of California to cause cancer. For more information go to www.P65Warnings.ca.gov.

Order Information

Example: PEFR-4-0500

PEFR-4-0500 – Flame Resistant Polyethylene

PEFR-4-0500 – **Tube O.D.** in sixteenths of an inch (**1/4"**)

PEFR-4-**0500** – **Package Quantity** in feet (**500'**)

Flame Resistant Polyethylene Tubing (Series PEFR) Maximum Working Pressure (psig)

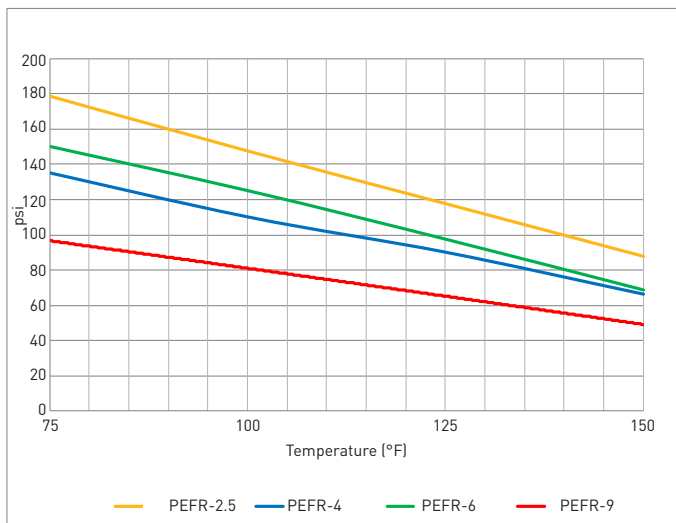

Fittings

Parker fittings available from:
 Fluid System Connectors Division
 Otsego, MI
 (269) 692-6555
 (269) 694-4614 FAX

- FSC Product Families:
- Compression
- Compress-Align
- Hi-Duty
- Fast & Tite®
- Prestolok® Brass
- Dubl-Barb®

For tube support use, reference Tubing/
 Fitting Compatibility Chart (pg. B-8/B-9) or
 contact Fluid System Connectors Division
 (269) 692-6555.

Notes

Using the same base linear low-density polyethylene (LLDPE) as the E-Series tubing, Parker Hannifin, Parflex Division's PEFR tubing has the following advantages:

- Resistant to environmental stress cracking exceeding that of ordinary polyethylene tubing as measured by ASTM D-1693 (10% IGEPAL)
- The operating temperature range for service at rated pressures with compatible fluids is -85°F (-65°C) to +150°F (66°C)

Colors

- Black



WARNING

This product can expose you to chemicals including Antimony Oxide (Antimony Trioxide), which is known to the State of California to cause cancer. For more information go to www.P65Warnings.ca.gov.

Polyethylene Tubing

Series HDPE: High Density



Features

- Manufactured from high strength, high density polyethylene
- Semi-rigid tubing that is inherently resistant to most chemicals, less easily cut or damaged and has a higher burst pressure rating than Series E tubing
- Economical system solution

Applications/Markets



- Chemical transfer
- Low-pressure pneumatics



Part Number	Tube O.D.		Tube I.D.		Average Wall Thickness		Working Pressure at 73°F /23°C		Minimum Burst at 73°F /23°C		Package Quantity	Minimum Bend Radius		Weight	
	inch	mm	inch	mm	inch	mm	psi	bar	psi	bar		inch	mm	lbs./ft.	kg./mtr.
#															
Black	inch	mm	inch	mm	inch	mm	psi	bar	psi	bar		inch	mm	lbs./ft.	kg./mtr.
HDPE-43-XXXX	1/4	6.4	.170	4.3	.040	1.0	300	20.7	1200	82.7	Package quantities vary by size and color	1.50	38.1	.011	.016
HDPE-64-XXXX	3/8	8.5	.250	6.4	.062	1.6	300	20.7	1200	82.7		2.50	63.5	.025	.037

Only available in black.



WARNING

This product can expose you to chemicals including Titanium dioxide, which is known to the State of California to cause cancer. For more information go to www.P65Warnings.ca.gov.

Order Information

Example: HDPE-43-0500

HDPE-43-0500 – High Density Polyethylene

HDPE-43-0500 – **Tube O.D.** in sixteenths of an inch (**1/4"**)

HDPE-43-0500 – **Tube I.D.** in sixteenths of an inch (**.170"**)

HDPE-43-0500 – **Package Quantity** in feet (**500'**)

High Density Polyethylene Tubing (Series HDPE)

Maximum Working Pressure (psig)

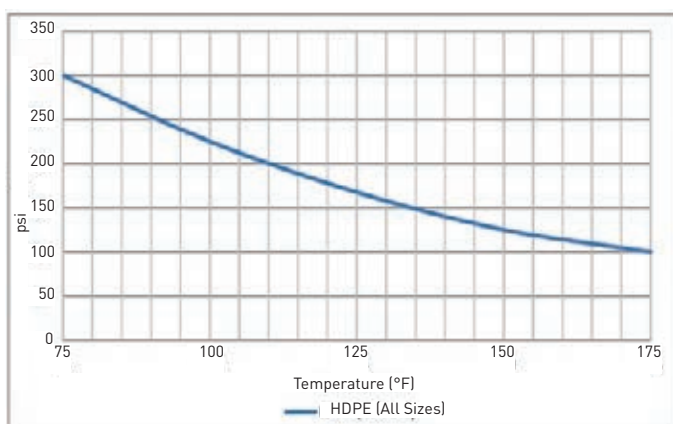

Fittings

Parker fittings available from:
Fluid System Connectors Division
Otsego, MI
(269) 692-6555
(269) 694-4614 FAX

- Compression
- Compress-Align
- Hi-Duty
- Fast & Tite®
- Prestolok® Brass
- Dubl-Barb®

For tube support use, reference Tubing/
Fitting Compatibility Chart (pg. B-8/B-9) or
contact Fluid System Connectors Division
(269) 692-6555.

Notes

- Recommended operating temperature range for service at rated pressures with compatible fluids is -80°F (-62°C) to +175°F (80°C)

Colors

- Black



WARNING

This product can expose you to chemicals including Titanium dioxide, which is known to the State of California to cause cancer. For more information go to www.P65Warnings.ca.gov.

Nylon Tubing

Series N: Flexible

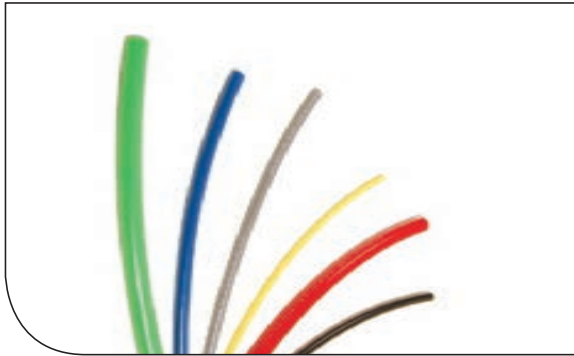

Features

- Flexible nylon tubing uses high-grade resins for strength and flexibility for routing in tight spaces
- Made from abrasion-resistant, heat and light-stabilized nylon
- Exhibits low-level water absorption
- Chemically resistant



Contact Customer Service for Retail Packaging Options

EZ Pack 100 foot boxes available for some sizes.

Applications/Markets



- Robotics
- Machine tool
- General pneumatics
- Lubrication

- Petroleum-based chemical transfer
- Pest control lines



Part Number	Part Number	Tube O.D.		Tube I.D.		Average Wall Thickness		Working Pressure at 73°F /23°C		Minimum Burst at 73°F /23°C		Package Quantity	Minimum Bend Radius		Weight	
		inch	mm	inch	mm	inch	mm	psi	bar	psi	bar		inch	mm	lbs./ft.	kg./mtr.
#	#															
Natural	Black	inch	mm	inch	mm	inch	mm	psi	bar	psi	bar	Package quantities vary by size and color	inch	mm	lbs./ft.	kg./mtr.
NN-2-016	NB-2-016	1/8	3.2	.093	2.4	.016	0.41	250	17.2	1000	69.0		.25	4.6	.003	.004
NN-2-031	NB-2-031	1/8	3.2	.064	1.6	.031	0.79	500	34.5	2000	137.9		.25	4.6	.004	.006
NN-2.5-025	NB-2.5-025	5/32	4.0	.106	2.7	.025	0.64	300	20.7	1200	82.7		.50	12.7	.005	.007
NN-3-025	NB-3-025	3/16	4.8	.138	3.5	.025	0.64	250	17.2	1000	69.0		.63	16.0	.006	.009
NN-3-046	NB-3-046	3/16	4.8	.096	2.4	.046	1.2	500	34.5	2000	137.9		.44	11.2	.009	.013
NN-4-035	NB-4-035	1/4	6.4	.180	4.6	.035	0.89	250	17.2	1000	69.0		.88	22.4	.011	.016
NN-4-040	NB-4-040	1/4	6.4	.170	4.3	.040	1.0	310	21.4	1250	86.2		.88	22.4	.012	.018
NN-4-062	NB-4-062	1/4	6.4	.127	3.2	.062	1.6	500	34.5	2000	137.9		.50	12.7	.017	.025
NN-5-040	NB-5-040	5/16	7.9	.233	5.9	.040	1.0	250	17.2	1000	69.0		1.13	28.7	.016	.024
NN-6-050	NB-6-050	3/8	9.5	.275	7.0	.050	1.3	250	17.2	1000	69.0		1.13	28.7	.023	.034
NN-6-093	NB-6-093	3/8	9.5	.190	4.8	.093	2.4	500	34.5	2000	137.9		.75	19.0	.038	.057
NN-8-062	NB-8-062	1/2	12.7	.375	9.5	.062	1.6	250	17.2	1000	69.0		1.25	31.8	.039	.058
NN-8-124	NB-8-124	1/2	12.7	.253	6.4	.124	3.2	500	34.5	2000	137.9	1.00	25.4	.067	.100	



WARNING

This product can expose you to chemicals including Nickel compounds, which is known to the State of California to cause cancer. For more information go to www.P65Warnings.ca.gov.

Order Information

Example: N-2-016-RED-0100

N-2-016-RED-0100 – Nylon

N-2-016-RED-0100 – **Tube O.D.** in sixteenths of an inch (**1/8"**)

N-2-**016**-RED-0100 – **Wall Thickness** in inches (**.016"**)







N-2-016-**RED**-0100 – **Colors** (Omit for Natural and Black)

NN-2-016-0100 - Natural Nylon

NB-2-016-0100 - Black Nylon

N-2-016-RED-**0100** – **Package Quantity** in feet (**100'**)

(Omit quantity number after color for 250' reel length)

Color Code		
	NN	Natural
	NB	Black
	BLU	Blue
	GRN	Green
	RED	Red
	YEL	Yellow

Nylon Tubing (Series N)

Maximum Working Pressure (psig)

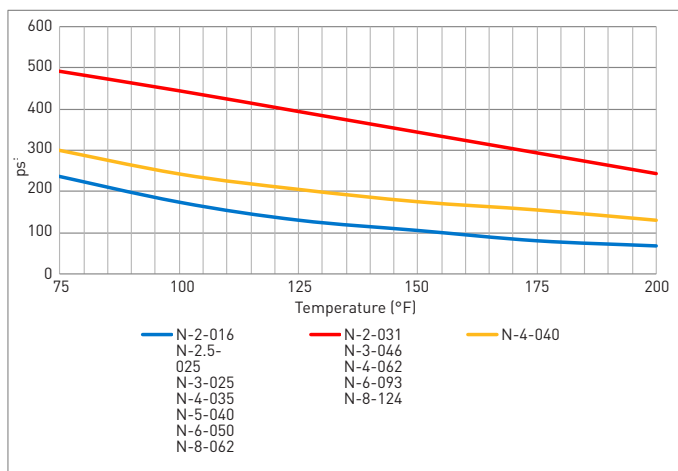

WARNING

This product can expose you to chemicals including Nickel compounds, which is known to the State of California to cause cancer. For more information go to www.P65Warnings.ca.gov.

Fittings

Parker fittings available from:
 Fluid System Connectors Division
 Otsego, MI
 (269) 692-6555
 (269) 694-4614 FAX

FSC Product Families:

- Compression
- Compress-Align®
- Poly-Tite
- Hi-Duty
- Fast & Tite
- Flow Controls
- Prestolok Brass
- Prestolok Composite
- Prestolok All-Metal
- Prestolok Stainless
- TrueSeal™
- NTA®
- Transmission

For tube support use, reference Tubing/
 Fitting Compatibility Chart (pg. B-8/B-9) or
 contact Fluid System Connectors Division
 (269) 692-6555.

Notes

- The operating temperature range for service at rated pressures with compatible fluids, depending upon conditions, is -65°F (-54°C) to +200°F (93°C)
- Black tubing suggested for use in sunlit areas and in close proximity to high ultraviolet light sources

Colors

- See Color Code Table

Metric Nylon Tubing

Series N: Flexible



Features

- Flexible nylon tubing uses high-grade resins for strength and flexibility for routing in tight spaces
- Made from abrasion-resistant, heat and light-stabilized nylon
- Exhibits low-level water absorption
- Chemically resistant

Applications/Markets



- Robotics
- Machine tool
- General pneumatics
- Lubrication
- Petroleum-based chemical transfer
- Pest control lines



Part Number	Part Number	Tube O.D.		Tube I.D.		Average Wall Thickness		Working Pressure at 73°F / 23°C		Minimum Burst at 73°F / 23°C		Package Quantity	Minimum Bend Radius		Weight	
		mm	inch	mm	inch	mm	inch	bar	psi	bar	psi		mm	inch	kg./mtr.	lbs./ft.
#	#															
Natural	Black	mm	inch	mm	inch	mm	inch	bar	psi	bar	psi		mm	inch	kg./mtr.	lbs./ft.
NN4X.65	NB4X.65	4	.157	2.7	.107	0.65	.026	20.7	300	82.7	1200	100	14	0.55	.007	.005
NN6X1	NB6X1	6	.236	4.0	.157	1.00	.039	23.5	341	94	1363	100	22	0.87	.016	.011
NN8X1	NB8X1	8	.315	6.0	.236	1.00	.039	17.0	247	68	986	100	29	1.14	.024	.016
NN10X1	NB10X1	10	.393	8.0	.315	1.00	.039	12.5	181	50	725	100	34	1.34	.030	.020
NN12X1	NB12X1	12	.472	10.0	.393	1.00	.039	11.0	160	44	638	100	45	1.77	.036	.024
NN14X1.5	NB14X1.5	14	.551	11.0	.433	1.50	.059	15.0	218	60	870	100	57	2.24	.063	.042
NN16X1.5	NB16X1.5	16	.630	13.0	.512	1.50	.059	12.5	181	50	725	100	74	2.91	.073	.049
NN18X1.5	NB18X1.5	18	.709	15.0	.591	1.50	.059	10.5	152	42	609	100	92	3.62	.082	.055
NN20X1.5	NB20X1.5	20	.787	17.0	.669	1.50	.059	9.5	138	38	551	100	112	4.41	.092	.062



WARNING

This product can expose you to chemicals including Nickel compounds, which is known to the State of California to cause cancer. For more information go to www.P65Warnings.ca.gov.

Order Information

Example: NN4x.65

NN4x.65 – Natural Nylon

NN4x.65 – Tube O.D. in millimeters (4mm)

NN4x.65 – Wall Thickness in millimeters (0.65mm)

Metric Nylon Tubing (Series N)

Maximum Working Pressure (bar)

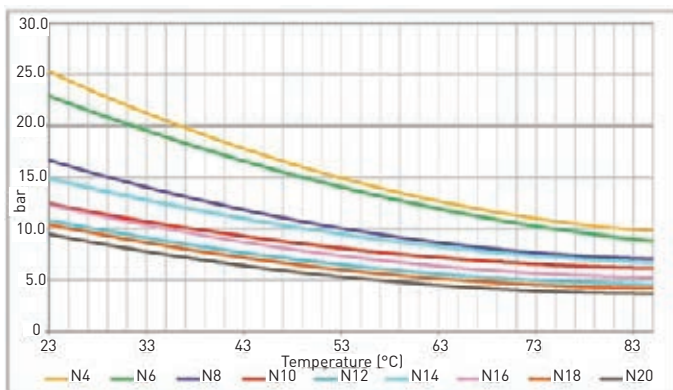

Fittings

Parker fittings available from:
 Fluid System Connectors Division
 Otsego, MI
 (269) 692-6555
 (269) 694-4614 FAX

FSC Product Families:

- Metric Compression
- Flow Controls
- Prestolok Composite
- Prestolok All-Metal
- Prestolok Stainless

For tube support use, reference Tubing/
 Fitting Compatibility Chart (pg. B-8/B-9)
 or contact Fluid System Connectors
 Division (269) 692-6555.

Notes

- The operating temperature range for service at rated pressures with compatible fluids, depending upon conditions, is -65°F (-54°C) to +200°F (93°C)
- Black tubing suggested for use in sunlit areas and in close proximity to high ultraviolet light sources

Colors

- Natural
- Black



WARNING

This product can expose you to chemicals including Nickel compounds, which is known to the State of California to cause cancer. For more information go to www.P65Warnings.ca.gov.

Nylon Pure Air Tubing

Series PAT: Ultra Pure, UV Resistant



Features

- The tubing choice for pure air systems (semiconductor) due to its cleanliness and excellent chemical and UV light resistance
- Maintains good resistance to high ambient temperatures with low moisture absorption
- Manufactured from a specially formulated nylon for use in pure air and gas distribution systems
- Provides high tensile strength with excellent coupling retention in high pressure, temperature and vibration environments
- Sizes -2 and -4 are single wall tubing construction
- Sizes -6 through -12 are reinforced tubing construction

Applications/Markets



- Pure air and gas distribution systems
- Semi-conductor



Part Number	Tube O.D.		Tube I.D.		Average Wall Thickness		Working Pressure at 73°F /23°C		Minimum Burst at 73°F /23°C		Package Quantity	Minimum Bend Radius		Weight	
	#	inch	mm	inch	mm	inch	mm	psi	bar	psi		bar	inch	mm	lbs./ft.
PAT2	1/8	3.2	.079	2.0	.023	0.58	250	17.2	1000	69.0	Package quantities vary by size and color	.37	9.4	.004	.006
PAT4	1/4	6.4	.170	4.3	.040	1.0	300	20.7	1200	82.7		1.00	25.4	.012	.018
PAT6	3/8	9.5	.251	6.4	.062	1.6	350	24.1	1400	96.4		1.50	38.1	.028	.042
PAT8	1/2	12.7	.376	9.6	.062	1.6	235	16.2	950	65.5		2.00	50.8	.040	.00
PAT10	5/8	15.9	.441	11.2	.092	2.3	225	15.5	900	62.1		2.50	63.5	.070	.104
PAT12	3/4	19.1	.566	14.4	.092	2.3	200	13.8	800	55.2		3.00	76.2	.087	.129



WARNING

This product can expose you to chemicals including Nickel compounds, which is known to the State of California to cause cancer. For more information go to www.P65Warnings.ca.gov.

Order Information

Example: PAT4-BLK-0250

PAT4-BLK-0250 – Pure Air Tubing

PAT4-BLK-0250 – **Tube O.D.** in sixteenths of an inch (**1/4"**)

PAT4-**BLK**-0250 – **Color (Black)**

PAT4-BLK-**0250** – **Package Quantity** in feet (**250'**)

Color Code		
●	BLK	Black
●	BRN	Brown
●	SIL	Silver

Pure Air Nylon Tubing (Series PAT)

Maximum Working Pressure (psig)

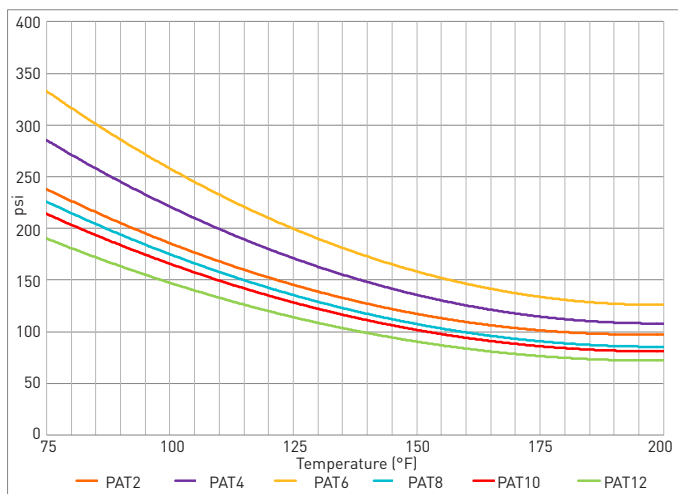

Fittings

Parker fittings available from:
 Fluid System Connectors Division
 Otsego, MI
 (269) 692-6555
 (269) 694-4614 FAX

FSC Product Families:

- Compression
- Compress-Align®
- Hi-Duty
- Fast & Tite
- NTA®

For tube support use, reference Tubing/Fitting Compatibility Chart (pg. B-8/B-9) or contact Fluid System Connectors Division (269) 692-6555.

Notes

- Packaged on corrugated plastic reel with ends capped and shipped in a plastic-lined container
- The operating temperature range for service at rated pressures with compatible fluids is -70°F (-57°C) to +200°F (93°C)
- PAT tubing is rated for full vacuum service at 28 inch Hg

Colors

- See Color Code Table



WARNING

This product can expose you to chemicals including Nickel compounds, which is known to the State of California to cause cancer. For more information go to www.P65Warnings.ca.gov.

Nylon Tubing





Series NR: Semi-rigid High Strength



Features

- High grade nylon resins without the addition of plasticizers for higher pressure tubing applications
- Chemical resistant, good resistance to high ambient temperature and low moisture absorption
- High tensile strength and excellent coupling retention in high pressure, temperature and vibration environments
- Better dimensional stability at elevated temperatures than N Series

Applications/Markets

- 

 - High-pressure pneumatics
 - Lubrication systems
 - Marine control systems
- 

 - Process lines for chemicals and oils

Part Number	Part Number	Tube O.D.		Tube I.D.		Average Wall Thickness		Working Pressure at 73°F /23°C		Minimum Burst at 73°F /23°C		Package Quantity	Minimum Bend Radius		Weight	
		inch	mm	inch	mm	inch	mm	psi	bar	psi	bar		inch	mm	lbs./ft.	kg./mtr.
NNR-2-017	NBR-2-017	1/8	3.2	.091	2.3	.017	0.43	425	29.3	1700	117.2	Package quantities vary by size and color	.50	12.7	.003	.004
NNR-2-026	NBR-2-026	1/8	3.2	.073	1.9	.026	0.66	625	43.1	2500	172.4		.38	9.7	.004	.006
NNR-3-024	NBR-3-024	3/16	4.8	.140	3.6	.024	0.61	425	29.3	1700	117.2		.75	19.0	.006	.009
NNR-3-039	NBR-3-039	3/16	4.8	.110	2.8	.039	0.99	625	43.1	2500	172.4		.63	16.0	.008	.012
NNR-4-035	NBR-4-035	1/4	6.4	.180	4.6	.035	0.89	425	29.3	1700	117.2		1.00	25.4	.011	.016
NNR-4-050	NBR-4-050	1/4	6.4	.150	3.9	.050	1.3	625	43.1	2500	172.4		.88	22.3	.014	.021
NNR-5-040	NBR-5-040	5/16	7.9	.233	5.9	.040	1.0	425	29.3	1700	117.2		1.50	38.1	.015	.022
NNR-6-048	NBR-6-048	3/8	9.5	.279	7.1	.048	1.2	425	29.3	1700	117.2		1.75	44.5	.022	.033
NNR-6-075	NBR-6-075	3/8	9.5	.225	5.7	.075	1.9	625	43.1	2500	172.4		1.50	38.1	.032	.048
NNR-8-062	NBR-8-062	1/2	12.7	.375	9.5	.062	1.6	375	26	1500	103.4		2.38	60.5	.038	.057
NNR-8-075	NBR-8-075	1/2	12.7	.350	8.9	.075	1.9	625	43.1	2500	172.4	2.50	63.5	.045	.067	

WARNING
 This product can expose you to chemicals including Nickel compounds, which is known to the State of California to cause cancer. For more information go to www.P65Warnings.ca.gov.

Order Information

Example: NBR-2-017-0100

NBR-2-017-0100 – Nylon

NBR-2-017-0100 – Color (Black)

NBR-2-017-0100 – Rigid

NBR-2-017-0100 – Tube O.D. in sixteenths of an inch (**1/8"**)

NBR-2-017-0100 – Wall Thickness in inches (**.017"**)

NBR-2-017-0100 – Package Quantity in feet (**100'**)

(Omit for other package quantities)

Semi-rigid Nylon Tubing (Series NR)

Maximum Working Pressure (psig)

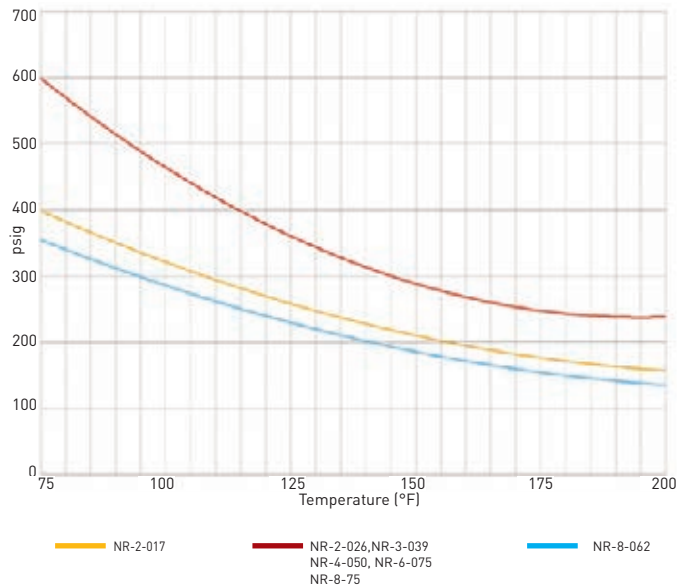

WARNING

This product can expose you to chemicals including Nickel compounds, which is known to the State of California to cause cancer. For more information go to www.P65Warnings.ca.gov.

Fittings

Parker fittings available from:
Fluid System Connectors Division
Otsego, MI
(269) 692-6555
(269) 694-4614 FAX

FSC Product Families:

- Compress-Align®
- Compression
- Fast & Tite®
- Flow Controls
- Hi-Duty
- Prestolok® All-Metal
- Prestolok® Brass
- Prestolok® Composite
- Prestolok® Stainless
- TrueSeal™

For tube support use, reference Tubing/
Fitting Compatibility Chart (pg. B-8/B-9) or
contact Fluid System Connectors Division
(269) 692-6555.

Notes

- The operating temperature range for service at rated pressures with compatible fluids is -60°F (-51°C) to +200°F (93°C)

Colors

- Natural
- Black

Polypropylene Tubing

Series PP: Laboratory Grade – FDA, NSF Listed
 Series PPB: Ultraviolet Light Resistant



Features

- Acid and chemically resistant
- May be used in higher temperatures and working pressures than polyethylene tubing
- Excellent compatibility with high temperature water
- Low water absorption (less than .01%)
- Good compatibility with vegetable oils
- Excellent resistance to environmental stress cracking

Certifications/Compliance

- FDA and NSF-51 - White tubing only

Applications/Markets



- Food contact - White only
- Chemical transfer
- Chlorinated water



Part Number	Part Number	Tube O.D.		Tube I.D.		Average Wall Thickness		Working Pressure at 73°F /23°C		Minimum Burst at 73°F /23°C		Package Quantity	Minimum Bend Radius		Weight		
		inch	mm	inch	mm	inch	mm	psi	bar	psi	bar		inch	mm	lbs./ft.	kg./mtr.	
#	#																
White	Black																
PP-21-1000	PPB-21-1000	1/8	3.2	.079	2.0	.023	0.58	350	24.1	1400	96.4	Package quantities vary by size and color	.50	12.7	.003	.004	
PP-32-0500	PPB-32-0500	3/16	4.8	.120	3.1	.034	0.86	350	24.1	1400	96.4		.75	14.4	.006	.009	
PP-43-0500	PPB-43-0500	1/4	6.4	.170	4.3	.040	1.0	300	20.7	1200	82.7		1.00	25.4	.010	.015	
PP-53-0500	PPB-53-0500	5/16	7.9	.188	4.8	.062	1.6	350	24.1	1400	96.4		1.25	31.8	.019	.028	
PP-64-0500	PPB-64-0500	3/8	9.5	.250	6.4	.062	1.6	300	20.7	1200	82.7		1.25	31.8	.024	.036	
PP-86-0250	PPB-86-0250	1/2	12.7	.375	9.5	.062	1.6	225	15.5	900	62.1		2.50	63.5	.033	.049	
PP-108-0100	PPB-108-0100	5/8	15.9	.500	12.7	.062	1.6	175	12.1	700	48.3		4.00	101.6	.042	.063	

Standard black is not FDA or NSF approved.



WARNING

This product can expose you to chemicals including Titanium dioxide, which is known to the State of California to cause cancer. For more information go to www.P65Warnings.ca.gov.

Order Information

Example: PP-86-0250

PP-86-0250 – Polypropylene

PP-**86**-0250 – **Tube O.D.** in sixteenths of an inch (**1/2"**)

PP-**86**-0250 – **Tube I.D.** in sixteenths of an inch (**.375"**)

PP-86-**0250** – **Package Quantity** in feet (**250'**)

Polypropylene Tubing (Series PP & PPB)

Maximum Working Pressure (psig)

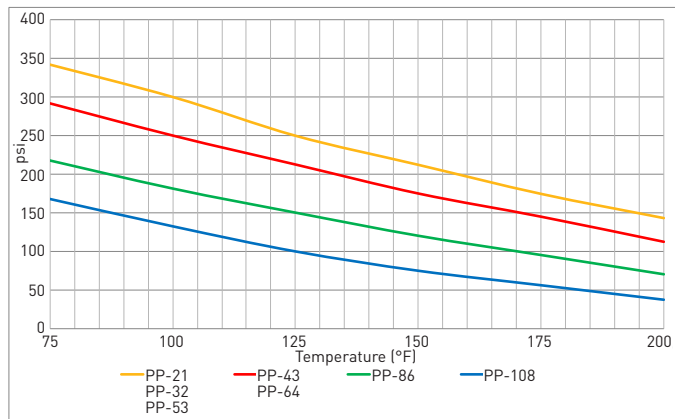

Fittings

Parker fittings available from:
Fluid System Connectors Division
Otsego, MI
(269) 692-6555
(269) 694-4614 FAX

FSC Product Families:

- Compression
- Compress-Align®
- Poly-Tite
- Hi-Duty
- Fast & Tite
- Prestolok Brass
- TrueSeal™

For tube support use, reference Tubing/
Fitting Compatibility Chart (pg. B-8/B-9) or
contact Fluid System Connectors Division
(269) 692-6555.

Notes

- The operating temperature range for service at rated pressures with compatible fluids is 0°F (-18°C) to +200°F (93°C)

Colors

- White
- Black



WARNING

This product can expose you to chemicals including Titanium dioxide, which is known to the State of California to cause cancer. For more information go to www.P65Warnings.ca.gov.

Polyurethane Tubing

Series U: Polyether Base



Features

- 90 to 95 Shore A durometer
- Excellent kink and abrasion resistance
- Excellent hydrolytic stability
- Flexible and easy to assemble onto designated Fittings
- Polyurethane tubing exhibits the elongation and recovery characteristics of rubber and the chemical resistance associated with plastics

Applications/Markets



- Pneumatic controls
- Robotics
- Machine tools
- General pneumatics
- Vacuum equipment
- Semiconductor equipment



Part Number	Tube O.D.		Tube I.D.		Average Wall Thickness		Working Pressure at 73°F / 23°C		Minimum Burst at 73°F / 23°C		Package Quantity	Weight	
	inch	mm	inch	mm	inch	mm	psi	bar	psi	bar		lbs.	kg.
#													
Natural												lbs./ft.	kg./mtr.
U-21-XXXX	1/8	3.2	.063	1.6	.031	0.79	125	8.6	375	25.9	Package quantities vary by size and color	.005	.007
U-32-XXXX	3/16	4.8	.125	3.2	.031	0.79	125	8.6	375	25.9		.008	.012
U-42-XXXX	1/4	6.4	.125	3.2	.063	1.6	125	8.6	375	25.9		.018	.027
U-64-XXXX	3/8	9.5	.250	6.4	.063	1.6	125	8.6	375	25.9		.030	.045
U-85-XXXX	1/2	12.7	.328	8.3	.086	2.2	125	8.6	375	25.9		.044	.065
U-86-XXXX	1/2	12.7	.375	9.5	.063	1.6	85	5.9	255	17.6		.042	.063
U-96-XXXX	9/16	14.3	.375	9.5	.094	2.4	125	8.6	375	25.9		.068	.101
U-128-XXXX	3/4	19.1	.500	12.7	.125	3.2	125	8.6	375	25.9		.120	.179

Also available in coils



Contact Customer Service for Retail Packaging Options

EZ Pack 100 foot boxes available for some sizes.



WARNING

This product can expose you to chemicals including Nickel compounds, which is known to the State of California to cause cancer. For more information go to www.P65Warnings.ca.gov.

Order Information

Example: U-21-BLK-0500

U-21-BLK-0500 – Polyurethane

U-21-BLK-0500 – **Tube O.D.** in sixteenths of an inch (**1/8"**)

U-21-BLK-0500 – **Tube I.D.** in sixteenths of an inch (**.063"**)

U-21-**BLK**-0500 – **Color (Black)** (Omit for Natural)

U-21-BLK-**0500** – **Package Quantity** in feet (**500'**)

Opaque Color Code		
●	-	Natural
●	BLK	Black
●	BLU	Blue
●	GRA	Gray
●	GRN	Green
●	ORG	Orange
●	RED	Red
●	WHT	White
●	YEL	Yellow

Transparent Color Code		
●	TBLU	Transparent Blue
●	TGRN	Transparent Green
●	TORG	Transparent Orange
●	TRED	Transparent Red
●	TYEL	Transparent Yellow

Polyurethane Tubing (Series U)

Maximum Working Pressure (psig)

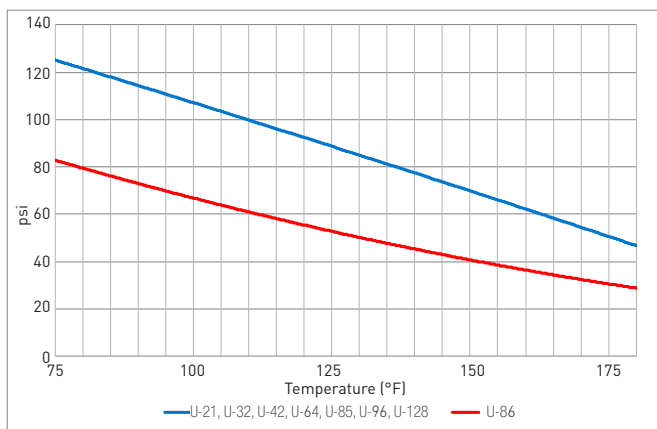

WARNING

This product can expose you to chemicals including Nickel compounds, which is known to the State of California to cause cancer. For more information go to www.P65Warnings.ca.gov.

Fittings

Parker fittings available from:
Fluid System Connectors Division
Otsego, MI
(269) 692-6555
(269) 694-4614 FAX

FSC Product Families:

- Fast & Tite
- TrueSeal™
- Par-Barb®

For tube support use, reference Tubing/
Fitting Compatibility Chart (pg. B-8/B-9) or
contact Fluid System Connectors Division
(269) 692-6555.

Notes

- The operating temperature range for service at rated pressures with compatible fluids is -40°F (-40°C) to +180°F (82°C)

Colors

- See Color Code Table

Metric Polyurethane Tubing

Series UM: Polyether Base

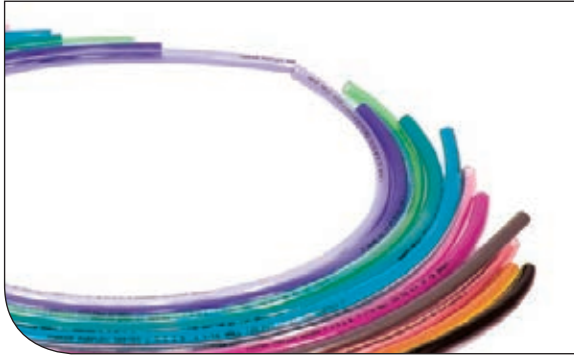

Features

- 90 to 95 Shore A durometer
- Excellent kink and abrasion resistance
- Excellent hydrolytic stability
- Flexible and easy to assemble onto designated Fittings
- Polyurethane tubing exhibits the elongation and recovery characteristics of rubber and the chemical resistance associated with plastics

Applications/Markets



- Pneumatic controls
- Robotics
- Machine tools
- General pneumatics
- Vacuum equipment
- Semiconductor equipment



Part Number	Tube O.D.		Tube I.D.		Average Wall Thickness		Working Pressure at 73°F /23°C		Minimum Burst at 73°F /23°C		Package Quantity	Weight	
	#				bar	psi	bar	psi					
Natural	mm	inch	mm	inch	mm	inch	bar	psi	bar	psi	Package quantities vary by size and color	kg./mtr.	lbs./ft.
UM4x2.5-XXXX	4	.157	2.5	.098	0.75	.030	9.0	131	26.0	377		.009	.006
UM6x4-XXXX	6	.236	4.0	.157	1.00	.039	9.0	131	26.0	377		.018	.012
UM8x5-XXXX	8	.315	5.0	.196	1.50	.059	9.0	131	26.0	377		.036	.024
UM10x6.5-XXXX	10	.393	6.5	.256	1.75	.069	9.0	131	26.0	377		.053	.036
UM12x8-XXXX	12	.472	8.0	.315	2.00	.079	9.0	131	26.0	377	.073	.049	



WARNING

This product can expose you to chemicals including Nickel compounds, which is known to the State of California to cause cancer. For more information go to www.P65Warnings.ca.gov.

Order Information

Example: UM6x4-BLK-0100

UM6X4-BLK-0100 – Polyurethane Metric

UM6X4-BLK-0100 – **Tube O.D.** in millimeters (**6 mm**)

UM6X4-BLK-0100 – **Tube I.D.** in millimeters (**4 mm**)

UM6X4-**BLK**-0100 – **Color (Black)** (Omit for Natural)

UM6X4-BLK-**0100** – **Package Quantity** in feet (**100'**)

Opaque Color Code		
○	-	Natural
●	BLK	Black
●	BLU	Blue
●	GRA	Gray
●	GRN	Green
●	ORG	Orange
●	RED	Red
●	YEL	Yellow

Transparent Color Code		
●	TBLU	Transparent Blue
●	TGRN	Transparent Green
●	TORG	Transparent Orange
●	TRED	Transparent Red
●	TYEL	Transparent Yellow

Metric Polyurethane Tubing (Series UM)

Maximum Working Pressure (bar)

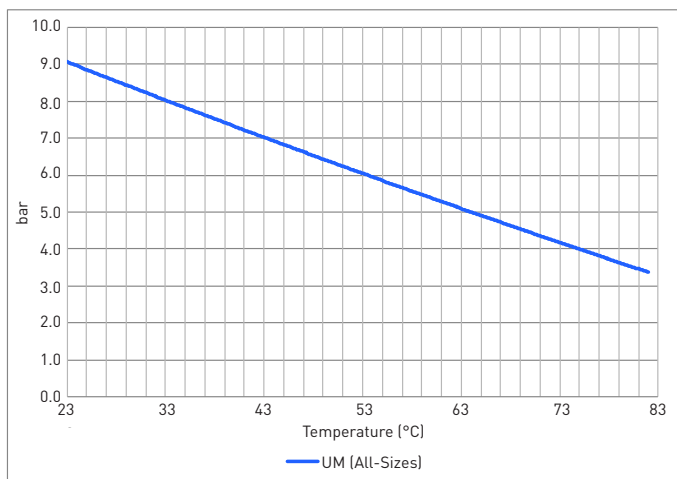

WARNING

This product can expose you to chemicals including Nickel compounds, which is known to the State of California to cause cancer. For more information go to www.P65Warnings.ca.gov.

Fittings

Parker fittings available from:
Fluid System Connectors Division
Otsego, MI
(269) 692-6555
(269) 694-4614 FAX

FSC Product Families:

- Prestolok Brass
- Par-Barb

For tube support use, reference Tubing/
Fitting Compatibility Chart (pg. B-8/B-9) or
contact Fluid System Connectors Division
(269) 692-6555.

Notes

- The operating temperature range for service at rated pressures with compatible fluids is -40°F (-40°C) to +180°F (82°C)

Colors

- See Color Code Table

Polyurethane Tubing

Series HU: High Durometer Polyether Base



Features

- 95 Shore A durometer or greater
- Excellent kink and abrasion resistance
- Excellent hydrolytic stability
- Flexible and easy to assemble onto designated Fittings
- Polyurethane tubing exhibits the elongation and recovery characteristics of rubber and the chemical resistance associated with plastics

Applications/Markets



- Pneumatic controls
- Robotics
- Machine tools
- General pneumatics
- Vacuum equipment
- Semiconductor equipment



Part Number	Tube O.D.		Tube I.D.		Average Wall Thickness		Working Pressure at 73°F / 23°C		Minimum Burst at 73°F / 23°C		Package Quantity	Weight	
	inch	mm	inch	mm	inch	mm	psi	bar	psi	bar		lbs./ft.	kg./mtr.
#													
HU-2-XXXX	1/8	3.2	.063	1.6	.031	0.79	300	20.7	900	62.1	Package quantities vary by size and color	.005	.007
HU-2.5-XXXX	5/32	4.0	.094	2.4	.031	0.79	210	14.5	630	43.4		.006	.009
HU-4-XXXX	1/4	6.4	.160	4.1	.045	1.1	180	12.4	540	37.2		.014	.021
HU-6-XXXX	3/8	9.5	.250	6.4	.062	1.6	180	12.4	540	37.2		.030	.045
HU-8-XXXX	1/2	12.7	.320	8.1	.090	2.3	180	12.4	540	37.2		.057	.085
HU-12-XXXX	3/4	19.1	.467	11.9	.142	3.6	180	12.4	540	37.2		.133	.198



WARNING

This product can expose you to chemicals including Nickel compounds, which is known to the State of California to cause cancer. For more information go to www.P65Warnings.ca.gov.

Order Information

Example: HU-2-BLK-0500

HU-2-BLK-0500 – High Durometer Polyurethane

HU-2-BLK-0500 – **Tube O.D.** in sixteenths of an inch (**1/8"**)

HU-2-**BLK**-0500 – **Color (Black)**

HU-2-BLK-**0500** – **Package Quantity** in feet (**500'**)

Color Code		
●	BLK	Black
●	BLU	Blue
●	DBL	Dark Blue
●	RED	Red
●	YEL	Yellow

Polyurethane Tubing (Series HU)

Maximum Working Pressure (psig)

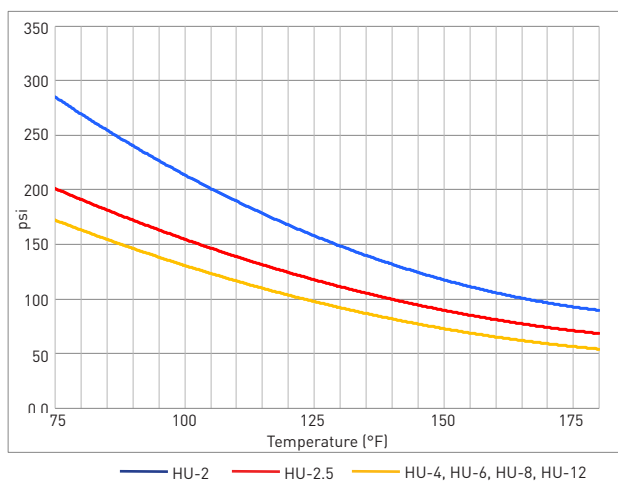

Fittings

Parker fittings available from:
Fluid System Connectors Division
Otsego, MI
(269) 692-6555
(269) 694-4614 FAX

FSC Product Families:

- Metric Compression
- Fast & Tite
- Flow Controls
- Prestolok Brass
- Prestolok Composite
- Prestolok All-Metal
- Prestolok Stainless
- TrueSeal™

For tube support use, reference Tubing/
Fitting Compatibility Chart (pg. B-8/B-9) or
contact Fluid System Connectors Division
(269) 692-6555.

Notes

- The operating temperature range for service at rated pressures with compatible fluids is -40°F (-40°C) to +180°F (82°C)

Colors

- See Color Code Table



WARNING

This product can expose you to chemicals including Nickel compounds, which is known to the State of California to cause cancer. For more information go to www.P65Warnings.ca.gov.

Metric Polyurethane Tubing

Series HUM: High Durometer (Metric) Polyether Base



Features

- 95 Shore A durometer or greater
- Excellent kink and abrasion resistance
- Excellent hydrolytic stability
- Flexible and easy to assemble onto designated Fittings
- Polyurethane tubing exhibits the elongation and recovery characteristics of rubber and the chemical resistance associated with plastics

Applications/Markets



- Pneumatic controls
- Robotics
- Machine tools
- General pneumatics
- Vacuum equipment
- Semiconductor equipment



Part Number	Tube O.D.		Tube I.D.		Average Wall Thickness		Working Pressure at 73°F / 23°C		Minimum Burst at 73°F / 23°C		Package Quantity	Weight	
	mm	inch	mm	inch	mm	inch	bar	psi	bar	psi		kg./mtr.	lbs./ft.
#													lbs
HUM-4-XXXX	4	.157	2.4	.094	0.80	.031	12.4	180	37.2	540	Package quantities vary by size and color	.009	.006
HUM-6-XXXX	6	.236	4.0	.157	1.00	.039	12.4	180	37.2	540		.018	.012
HUM-8-XXXX	8	.315	5.0	.196	1.50	.059	12.4	180	37.2	540		.036	.024
HUM-10-XXXX	10	.393	6.5	.256	1.75	.069	12.4	180	37.2	540		.053	.036
HUM-12-XXXX	12	.472	8.0	.315	2.00	.079	12.4	180	37.2	540		.073	.049

WARNING
 This product can expose you to chemicals including Nickel compounds, which is known to the State of California to cause cancer. For more information go to www.P65Warnings.ca.gov.

Order Information

Example: HUM-6-BLK-0100

HUM-6-BLK-0100 – High Durometer Metric Polyurethane
 HUM-6-BLK-0100 – Tube O.D. in millimeters (6mm)
 HUM-6-BLK-0100 – Color (Black)
 HUM-6-BLK-0100 – Package Quantity in feet (100')

Metric Polyurethane Tubing (Series HUM) Maximum Working Pressure (bar)

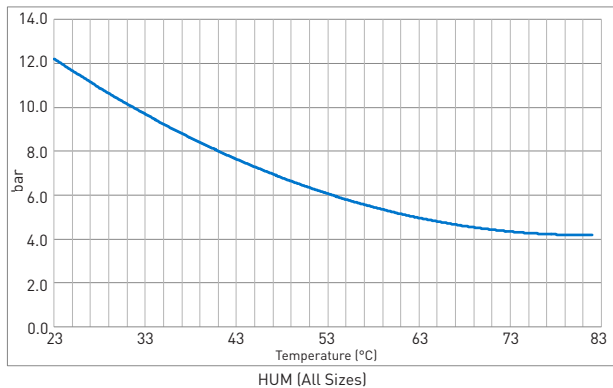

Fittings

Parker fittings available from:
 Fluid System Connectors Division
 Otsego, MI
 (269) 692-6555
 (269) 694-4614 FAX

FSC Product Families:

- Metric Compression
- Flow Controls
- Prestolok Composite
- Prestolok All-Metal
- Prestolok Stainless

For tube support use, reference Tubing/
 Fitting Compatibility Chart (pg. B-8/B-9) or
 contact Fluid System Connectors Division
 (269) 692-6555

Notes

- The operating temperature range for service at rated pressures with compatible fluids is -40°F (-40°C) to +180°F (82°C)

Colors

- Natural
- Black



WARNING

This product can expose you to chemicals including Nickel compounds, which is known to the State of California to cause cancer. For more information go to www.P65Warnings.ca.gov.

MicroWeld™ Tubing

Series 95FR: Flame Resistant

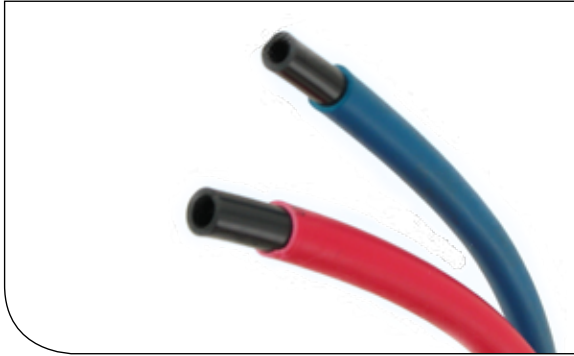

Features

- 95 Shore A durometer core tube
- Easily skived flame resistant jacket protects core tube for extended life
- Silicone and halogen free
- Excellent flexibility
- Weld spatter resistant
- Ideal for air/water supply in robotic welding applications

Certifications

- UL94 V-0 compliant jacket material

Applications/Markets



- Robotic Welding
- End-of-Arm Tooling
- General Robotics
- Pneumatic Systems
- General Automation

Fractional (Inch)

Part Number	Tube O.D.		Tube I.D. (ref)		Wall Thickness		Final Sheath O.D.		Final Sheath Wall Thickness		Working Pressure at 73°F		Minimum Burst at 73°F		Minimum Bend Radius		Package Quantity	Weight	
	inch	mm	inch	mm	inch	mm	inch	mm	inch	mm	psi	bar	psi	bar	inch	mm		feet	lbs./ft.
95FR-4	1/4	6.4	.125	3.2	.045	1.1	.340	8.6	.045	1.1	240	17	720	50	3/4	19	250, 500	.042	.062
95FR-6	3/8	9.5	.250	6.4	.062	1.6	.465	11.8	.045	1.1	230	16	690	48	1	25	250, 500	.069	.102
95FR-8	1/2	12.7	.320	8.1	.090	2.3	.590	15	.045	1.1	220	15	660	46	2	51	250	.108	.161

Metric

Part Number	Tube O.D.		Tube I.D. (ref)		Wall Thickness		Final Sheath O.D.		Final Sheath Wall Thickness		Working Pressure at 23°C		Minimum Burst at 23°C		Minimum Bend Radius		Package Quantity	Weight	
	mm	inch	mm	inch	mm	inch	mm	inch	mm	inch	bar	psi	bar	psi	mm	inch		feet	kg./mtr.
95FRM-6	6	.236	4	.157	1	.039	8	.315	1.1	.045	15	218	45	653	20	.787	250, 500	.056	.038
95FRM-8	8	.315	5	.197	1.5	.059	10	.394	1.1	.045	18	261	54	783	22	.866	250, 500	.085	.057
95FRM-10	10	.394	6.5	.256	1.75	.069	12	.472	1.1	.045	16	232	48	696	26	1.02	250	.113	.076
95FRM-12	12	.472	8	.315	2	.078	14	.551	1.1	.045	16	232	48	696	32	1.26	250	.144	.097

WARNING This product can expose you to chemicals including Antimony Oxide (Antimony Trioxide), which is known to the State of California to cause cancer. For more information go to www.P65Warnings.ca.gov.

Order Information

Example: 95FR-4-BLU-0250

95FR-4-BLU-0250 – High Durometer Polyurethane
 95FR-4-BLU-0250 – **Tube O.D.** in sixteenths of an inch (**1/4"**)
 95FR-4-**BLU**-0250 – **Color (Blue)**
 95FR-4-BLU-**0250** – **Package Quantity** in feet (**250'**)

Fittings

Parker fittings available from:
 Fluid System Connectors Division
 Otsego, MI
 (269) 692-6555
 (269) 694-4614 FAX

FSC Product Family:

- PrestoWeld
- PLM

Notes:

The operating temperature range for service at rated pressures with compatible fluids is -40°F to +165°F (-40°C to +75°C)

Colors

- See Color Code Table

Additional Color Code		
●	BLU	Blue
●	BLK	Black
●	GRN	Green
●	RED	Red
○	WHT	White

Fractional MicroWeld™ Tubing (Series 95FR)

Maximum Working Pressure (psig)

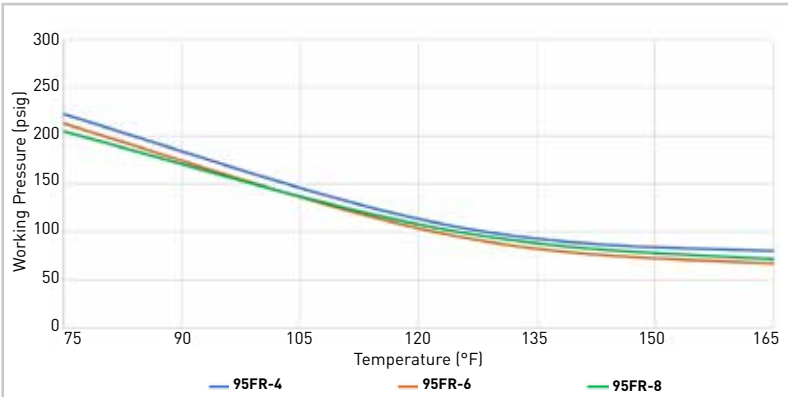

Metric MicroWeld™ Tubing (Series 95FR)

Maximum Working Pressure (bar)

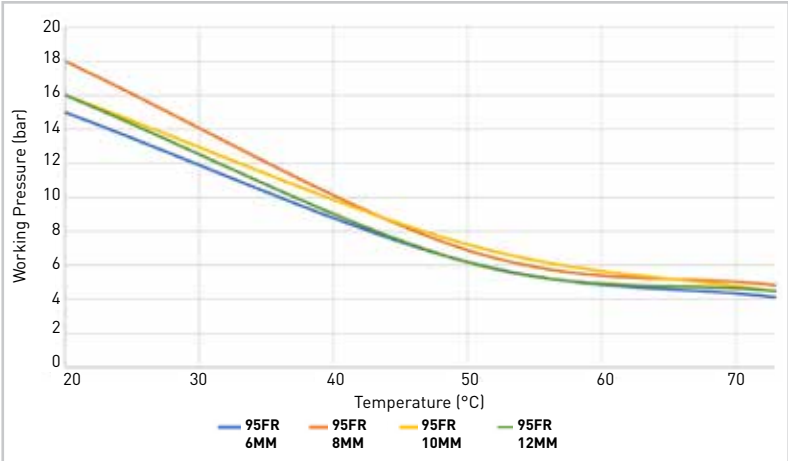

WARNING This product can expose you to chemicals including Antimony Oxide (Antimony Trioxide), which is known to the State of California to cause cancer. For more information go to www.P65Warnings.ca.gov.

Vinyl Tubing

Series PV: Clear Vinyl Tubing

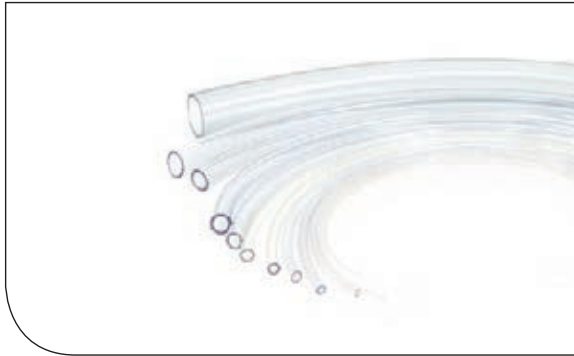

Features

- Made from a virgin clear PVC (polyvinyl chloride) resin; specifically formulated for exceptional purity, clarity and flexibility
- 70 durometer for soft, easy handling and bending without tubing collapse

Certifications

- FDA compliant

Applications/Markets



- Low-pressure chemicals
- Pneumatics
- Low-pressure sight flow indicator

Order Information

Example: PV108-1

PV108-1 – Poly-Vinyl Tubing

PV108-1 – **Tube O.D.** in sixteenths of an inch **(5/8")**

PV108-1 – **Tube I.D.** in sixteenths of an inch **(1/2")**

PV108-1 – **Formula V-1 FDA Approved Formulation**

Notes

- Formula V-1 tubing fully meets all specifications called out by the United States Food and Drug Administration (FDA) for materials in contact with food and drugs for human consumption
- The operating temperature range for service at rated pressures with compatible fluids is -40°F (-40°C) to +150°F (65°C)

Fittings

Parker fittings available from:
Fluid System Connectors Division
Otsego, MI
(269) 692-6555
(269) 694-4614 FAX

FSC Product Families:

- Poly-Tite
- TrueSeal™
- Hose Barb
- Fast & Tite
- Par-Barb®
- Garden Hose

For tube support use, reference Tubing/Fitting Compatibility Chart (pg. B-8/B-9) or contact Fluid System Connectors Division (269) 692-6555.









WARNING

This product can expose you to chemicals including Di(2-ethylhexyl) phthalate (DEHP), which is known to the State of California to cause cancer and birth defects or other reproductive harm. For more information go to www.65Warnings.ca.gov.

Vinyl Tubing (cont.)

Series PV: Clear Vinyl Tubing

Part Number	Tube O.D.		Tube I.D.		Average Wall Thickness		Working Pressure at 73°F / 23°C		Std. Coil	Weight	
	inch	mm	inch	mm	inch	mm	psi	bar		feet	lbs./ft.
#											
PV21-1	1/8	3.2	.063	1.6	.031	.79	35	2.4	100	.005	.007
PV32-1	.170	4.3	.125	3.2	.025	.64	35	2.4	100	.006	.009
PV42-1	1/4	6.4	.125	3.2	.063	1.6	65	4.5	100	.025	.037
PV43-1	1/4	6.4	.170	4.3	.040	1.2	55	3.8	100	.014	.021
PV403-1	1/4	6.4	.188	4.8	.031	.79	22	1.5	100	.011	.016
PV53-1	5/16	7.9	.188	4.8	.063	1.6	55	3.8	100	.025	.037
PV63-1	3/8	9.5	.188	4.8	.094	2.4	65	4.5	100	.043	.064
PV73-1	7/16	11.1	.188	4.8	.125	3.2	75	5.2	100	.063	.094
PV54-1	5/16	7.9	.250	6.4	.031	.79	20	1.4	100	.014	.021
PV64-1	3/8	9.5	.250	6.4	.064	1.6	55	3.8	100	.032	.048
PV74-1	7/16	11.1	.250	6.4	.094	2.4	60	4.1	100	.052	.077
PV84-1	1/2	12.7	.250	6.4	.125	3.2	70	4.8	100	.076	.113
PV75-1	7/16	11.1	.313	7.9	.063	1.6	50	3.4	100	.038	.057
PV85-1	1/2	12.7	.313	7.9	.094	2.4	60	4.1	100	.062	.092
PV95-1	9/16	14.3	.313	7.9	.125	3.2	70	4.8	100	.088	.131
PV86-1	1/2	12.7	.375	9.5	.063	1.6	45	3.1	100	.044	.065
PV96-1	9/16	14.3	.375	9.5	.094	2.4	50	3.4	100	.071	.106
PV106-1	5/8	15.9	.375	9.5	.125	3.2	60	4.1	100	.101	.150
PV97-1	9/16	14.3	.438	11.1	.063	1.6	40	2.8	100	.050	.074
PV107-1	5/8	15.9	.438	11.1	.094	2.4	45	3.1	100	.080	.119
PV117-1	11/16	17.5	.438	11.1	.125	3.2	50	3.4	100	.115	.171
PV108-1	5/8	15.9	.500	12.7	.063	1.6	30	2.1	100	.057	.085
PV118-1	11/16	17.5	.500	12.7	.094	2.4	40	2.8	100	.089	.132
PV128-1	3/4	19.1	.500	12.7	.125	3.2	45	3.1	100	.126	.187
PV138-1	13/16	20.7	.500	12.7	.156	4.0	60	4.1	100	.167	.248
PV129-1	3/4	19.1	.563	14.3	.094	2.4	40	2.8	100	.099	.147
PV139-1	13/16	20.7	.563	14.3	.125	3.2	45	3.1	100	.138	.205
PV1310-1	13/16	20.7	.625	15.9	.094	2.4	35	2.4	100	.108	.161
PV1410-1	7/8	22.2	.625	15.9	.125	3.2	40	2.8	100	.151	.225
PV1510-1	15/16	23.8	.625	15.9	.156	4.0	50	3.5	100	.196	.292
PV1411-1	7/8	22.2	.688	17.5	.094	2.4	30	2.1	100	.118	.176
PV1611-1	1	25.4	.688	17.5	.156	4.0	45	3.1	100	.213	.317









WARNING

This product can expose you to chemicals including Di(2-ethylhexyl) phthalate (DEHP), which is known to the State of California to cause cancer and birth defects or other reproductive harm. For more information go to www.65Warnings.ca.gov.

Vinyl Tubing (cont.)

Series PV: Clear Vinyl Tubing

Part Number	Tube O.D.		Tube I.D.		Average Wall Thickness		Working Pressure at 73°F / 23°C		Std. Coil	Weight	
	#										
	inch	mm	inch	mm	inch	mm	psi	bar	feet	lbs./ft.	kg./mtr.
PV1612-1	1	25.4	.750	19.1	.125	3.2	35	2.4	100	.176	.262
PV1712-1	1-1/16	27.0	.750	19.1	.156	4.0	35	2.4	100	.228	.339
PV1812-1	1-1/8	28.6	.750	19.1	.188	4.8	50	3.5	100	.283	.421
PV2012-1	1-1/4	31.8	.750	19.1	.250	6.4	55	3.8	50	.409	.609
PV1814-1	1-1/8	28.6	.875	22.2	.125	3.2	30	2.1	50	.201	.299
PV1914-1	1-3/16	30.2	.875	22.2	.156	4.0	35	2.4	100	.259	.385
PV2014-1	1-1/4	31.8	.875	22.2	.188	4.8	45	3.1	50	.321	.478
PV2016-1	1-1/4	31.8	1.000	25.4	.125	3.2	25	1.7	50	.230	.342
PV2116-1	1-5/16	33.4	1.000	25.4	.156	4.0	30	2.1	50	.291	.433
PV2216-1	1-3/8	34.9	1.000	25.4	.188	4.8	40	2.8	50	.359	.534
PV2416-1	1-1/2	38.1	1.000	25.4	.250	6.4	45	3.1	50	.514	.765
PV2218-1	1-3/8	34.9	1.125	28.6	.125	3.2	25	1.7	50	.252	.375
PV2420-1	1-1/2	38.1	1.250	31.8	.125	3.2	20	1.4	50	.277	.412
PV2620-1	1-5/8	41.3	1.250	31.8	.188	4.8	35	2.4	50	.434	.646
PV2820-1	1-3/4	44.4	1.250	31.8	.250	6.4	45	3.1	50	.604	.899
PV3024-1	1-7/8	47.6	1.500	38.1	.188	4.8	30	2.1	50	.510	.759
PV3224-1	2	50.8	1.500	38.1	.250	6.4	40	2.8	50	.705	1.05
PV3628-1	2-1/4	57.2	1.750	44.4	.250	6.4	30	2.1	50	.806	1.20
PV4032-1	2-1/2	63.5	2.000	50.8	.250	6.4	35	2.4	50	.906	1.35

**WARNING**

This product can expose you to chemicals including Di(2-ethylhexyl) phthalate (DEHP), which is known to the State of California to cause cancer and birth defects or other reproductive harm. For more information go to www.65Warnings.ca.gov.

Fluoropolymer Tubing

Fluoropolymer Tubing

Fluoropolymer tubing features a low coefficient of friction and anti-stick properties, high temperature capabilities and the most corrosion and chemical resistance of all polymers. Within normal use temperatures, fluoropolymers are attacked by so few chemicals that it is easier to describe the exceptions rather than list the chemicals they are compatible with (see Chemical Resistance Summary, pg. B-46). These chemically inert tubes are non-wetting and non-leaching, making them ideal for a wide range of fluid and material handling applications.

Parker fluoropolymer tubing is available in PTFE, FEP and PFA with some materials operating at temperatures up to 500°F (260°C). Each material has specific dominant characteristics, but all operate in high-temperature, corrosive environments.

- Parflex PTFE, FEP, and PFA tubing complies with European Standard RoHs and are also FDA compliant to FDA regulation 21 CFR 177.1550, making these products suitable for use in food and beverage applications.
- Parflex PTFE, FEP and PFA are listed VW-1 in the burning test for Underwriters Laboratories and pass the UL-83 vertical flame test. In a flame situation, PTFE, FEP and PFA tubing resist combustion and do not promote flame spread.

All fluoropolymer tubing dimensions are continuously monitored to ensure an overall quality product. Most tubing sizes are packaged in convenient 25-ft., 50-ft., 100-ft. and 1,000-ft. lengths.

PTFE

- PTFE (Polytetrafluoroethylene) is offered in smoothbore tubing, heat shrinkable, spiral wrap and convoluted tubing.
- PTFE tubing features unmatched chemical resistance and a non-stick surface that facilitates flow and eliminates media buildup.

FEP

- FEP (Fluorinated Ethylene Propylene) is available in smoothbore tubing, heat shrinkable, convoluted, corrugated and retractable coil tubing.
- FEP tubing offers the highest clarity in the fluoropolymer market and is a close second to PTFE in chemical resistance.
- FEP is available in long, continuous lengths (1,000 feet and longer) whereas the longest lengths for PTFE range from 200 to 1,000 feet depending on size and wall thickness.

Fluoropolymer Tubing

Product Family	Type	Series		Suggested Applications		Suggested Markets
PTFE	Smoothbore	TFH TFS	TFT TFL	Electrical Insulation Protective Cover	Circuit Board Wire Insulation	Chemical High-Temp Food Instrumentation Laboratory Gas Sampling Electrical Insulation Fluid Handling Industrial Equipment Ground Support
	Smoothbore	101	201	Electrical Insulation Fluid Transfer	Gas Sampling Laboratory	
	Heat Shrink	HS2T	HS4T	Electrical Insulation Protective Cover	Circuit Board Rollers	
	Convolute	CV CVL	CVH 81914	Fluid Transport Wire Harness	Protection/Cable Core Robotics	
	Spiral Wrap	TSWTF		Cable Harnessing	Wiring closets	
FEP	Smoothbore	103	203	Nitrogen Filling Downhole Pump Ozone Sampling	Hearing Aid Optical Sensors	UV Applications Chemical Instrumentation Laboratory Gas Dispensing Gas Sampling Robotics Fluid Handling Food & Beverage Semiconductor Pharmaceutical Electrical Industrial Equipment Medical
	Heat Shrink	HS1.3 HS1.6	HS1.25	Protective Covering UV Light Covering Product Testing	Paper Rollers Ink Rollers	
	Convolute	CV	81914	Fluid Transport Wire Harness	Protection/Cable Core Robotics	
	Corrugated	CR		Vacuum Applications Wet Bench DNA Sequencer	Fluid Transfer Robotics	
	Retractable	703		Lab Equipment Gas Dispensing	Wet Bench Dual Containment	
PFA H.P. PFA	Smoothbore	104	204	Air Sampling Gas Purge Wet Bench	Flow Monitoring Steam Plant	Chemical Laboratory Semiconductor Instrumentation Food Environmental Fluid Handling Gas Service Pharmaceutical Medical
	High Purity Smoothbore	105	205	Flow Monitoring Systems High Purity Apps. DI Water Dispensers	DI Recirculators Heat Exchangers Pure Chemical Dispensers	
	Retractable	704	705	Lab Equipment Gas Dispensing	Wet Bench Dual Containment	

PFA

- PFA (Perfluoroalkoxy) is available in smoothbore tubing.
- When temperature and clarity are both factors, PFA is the resin of choice because it offers the high-temperature attributes of PTFE, long continuous lengths, and almost as much clarity as FEP.
- High purity resins available.
- Low permeability.

PFA

- H.P. PFA (Perfluoroalkoxy) has the highest molecular weight available.
- Withstands corrosive surfactants for longer periods of time than standard products.
- Lowest level of extractables.

A
Hose

B
Tubing
Fluoropolymer

C
Coiled Air Hose
& Fittings

D
Transportation

E
Fittings

F
Tooling,
Equipment
& Accessories

G
General
Technical

Fluoropolymer Quick Reference

PTFE (Polytetrafluoroethylene)

Working Temperature: 500°F (260°C)

Color: Opaque to translucent

- Chemically inert
- Lowest coefficient of friction
- Superior dielectric strength
- Exceptional heat resistance
- Self extinguishing
- Non-wetting
- Excellent flexlife
- Laser markable

PFA (Perfluoroalkoxy)

Working Temperature: 500°F (260°C)

Color: Clear with light blue or tint

- High purity resins available
- Low permeation resins available
- Use when you need the temperature range of PTFE and the clarity of FEP
- Exceptional heat resistance
- Self extinguishing
- Non-wetting
- Good flexlife

FEP (Fluorinated Ethylene Propylene)

Working Temperature: 400°F (204°C)

Color: Clear

- Excellent chemical resistance
- Non-wetting
- Weldable
- Tubes can be sealed by melting
- Long continuous lengths
- Low refractive index
- Improved clarity over PFA
- Lower cost alternative to PFA

Chemical Resistance Summary



Within normal use, temperatures, fluoropolymers are attacked by so few chemicals that it is easier to describe the exceptions rather than list the chemicals they are compatible with.

DO NOT USE FLUOROPLASTICS WITH THE FOLLOWING:

- Alkali metals such as elemental sodium, potassium, lithium, etc. The alkali metals remove fluorine from the polymer molecule.
- Extremely potent oxidizers, fluorine (F₂) and related compounds (e.g., chlorine trifluoride, ClF₃). These can be handled by fluoropolymers, but only with great care, as fluorine is absorbed into the resins, and the mixture becomes sensitive to a source of ignition such as impact.
- 80% NaOH (Sodium Hydroxide) or KOH (Potassium Hydroxide), metal hydrides such as Boranes (e.g., B₂H₆), Aluminum Chloride, Ammonia (NH₃), certain Amines (R-NH₂) and imines (R=NH) and 70% Nitric Acid at temperatures near the suggested service limit.



WARNING

FAILURE OR IMPROPER SELECTION OR IMPROPER USE OF THE PRODUCTS AND/OR SYSTEMS DESCRIBED HEREIN OR RELATED ITEMS CAN CAUSE DEATH, PERSONAL INJURY AND PROPERTY DAMAGE.

This document and other information from Parker Hannifin Corporation, its subsidiaries and authorized distributors provide product and/or system options for further investigation by users having technical expertise. It is important that you analyze all aspects of your application and review the information concerning the product or system in the current product catalog. Due to the variety of operating conditions and applications for these products or systems, the user, through its own analysis and testing, is solely responsible for making the final selection of the products and systems and assuring that all performance, safety and warning requirements of the application are met.

The products described herein, including without limitation, product features, specifications, designs, availability and pricing, are subject to change by Parker Hannifin Corporation and its subsidiaries at any time without notice.

Fluoropolymer Tubing

Fluoropolymer Resin Comparison

The table below lists a generally accepted summary of properties that we believe to be reliable. Please note that many of these resins are produced in several varieties and property characteristics may vary. Therefore, determination of resin is dependent on the application and this table is only meant to serve as a general guideline.

Properties*	ASTM or Unit	PTFE	FEP	PFA	High Purity PFA
MECHANICAL PROPERTIES					
Specific Gravity	D792 D3307	2.13-2.22 -	2.12-2.17 -	2.12-2.17 -	- 2.14-2.16
Elongation %	D638 D3307	200-450 -	250-330 -	280-400 -	- 370
Tensile Strength (psi)	D638(psi) D3307(psi)	2000-7000 -	2800-4000 -	4000-5000 -	- 4693
Flexural Strength (psi)	D790	no break	no break	no break	no break
Compressive Strength (psi)	D695	700-900	725-2200	725-810	na
Tensile Elastic Modulus (Young's Modulus) (psi)	D638	57,000 -	50,000 -	72,500- 87,000	na
Flexural Modulus	D790(psi) D790 103MPa (103kgf/cm2)	71,000-85,000 0.5-0.6 (5.0-6.0)	78,000-92,000 0.5-0.6 (5.5-6.4)	94,000-99,000 0.6-0.7 (6.6-7.0)	- 647-686 -
Flex Life (MIT cycles)	D2176	>1,000,000	5,000-80,000	10,000-500,000	2000 x 10 ³
Hardness Durometer Shore D	D2240	D50-65	D55	D55-D60	D60
Coefficient of Friction	(on steel)	0.02	0.05	0.04-0.06	0.05
Abrasion Resistance 1000 cycles	Taber	8-90	14-20	0.00-96.75	na
Impact Strength IZOD. 73°F (23°C) notched ft/lbs/in	D256	3	no break	no break	no break
THERMAL PROPERTIES					
Melting Point	°C °F	327 621	260 500	305 582	305 582
Upper Service Temperature(20000h)	°C °F	260 500	204 400	260 500	260 500
Flammability	UL 94	V-0	V-0	V-0	V-0
Thermal Conductivity BTU-in/hr-ft ² , °F		1.7-2.08	1.4	1.3	na
Thermal Conductivity Cal-cm/sec-cm ² , °C		6 x 10 ⁻⁴	6 x 10 ⁻⁴	6 x 10 ⁻⁶	na
Linear Coefficient of Thermal Expansion Min/in°F 73.4-140°F	D696	55.6	46.1-58.3	66.7	na
Heat of Fusion	BTU/LB	29-37	4-35	13	na
Heat of Combustion	BTU/LB °F	2200	2200	2300	na
Low Temperature Embrittlement	°C °F	-268 -450	-268 -450	-268 -450	-268 -450
ELECTRICAL PROPERTIES					
Dielectric Constant	D150/10 ³ Hz D150/10 ⁶ Hz	2.1 2.1	2.1 2.1	2.1 2.1	2.1 2.1
Dielectric Strength	D149/125 MIL D149/10 MIL	500 ≥1400	508 >610	500 ≥1400	500 - 600 na
Volume Resistivity	D257/ohm-cm	>10 ¹⁸	>10 ¹⁸	>10 ¹⁸	na
Surface Resistivity	D257/ohm-cm	>10 ¹⁸	>10 ¹⁷	>10 ¹⁷	na
GENERAL PROPERTIES					
Chemical/Solvent Resistance	D543	Excellent	Excellent	Excellent	Excellent
Refractive Index		1.35	1.338	1.34	1.34
Limiting Oxygen Index, %	D2868	>95	>95	≥95	na
Water Contact Angle	Angle to Level	110	114	115	na
Water Absorption 24h,%	D570	<0.01	<0.01	<0.03	<0.01
Weatherability		Excellent	Excellent	Excellent	Excellent

*General resin properties; Tubing properties may vary.

Tubing Pressure Ranges

Tubing pressures vary by material, tubing size and wall thickness. Please contact Customer Service for specific pressures.

Fluoropolymer Tubing

Fluoropolymer Tubing Nomenclature

Smoothbore Fractional and Metric Tubing

105- 0250 062 - N T - 100

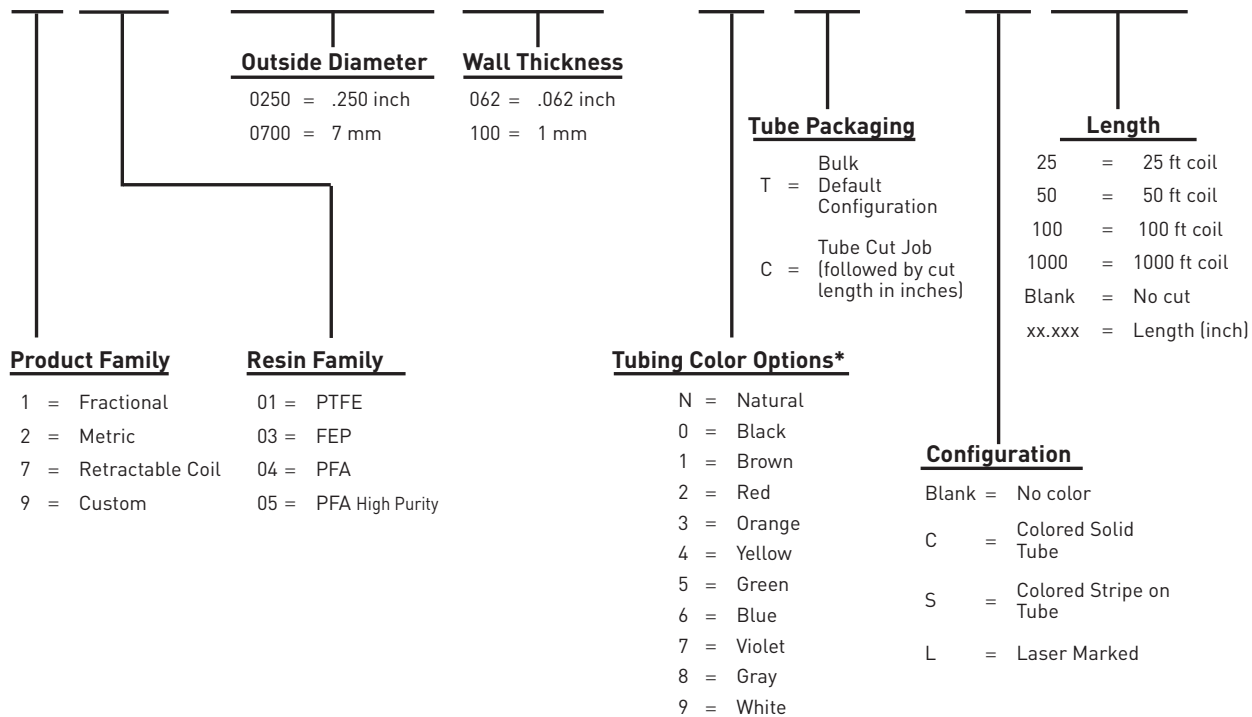

Convolute and Corrugated Tubing

CV01- 1/8ID- 88- 1.5-2C

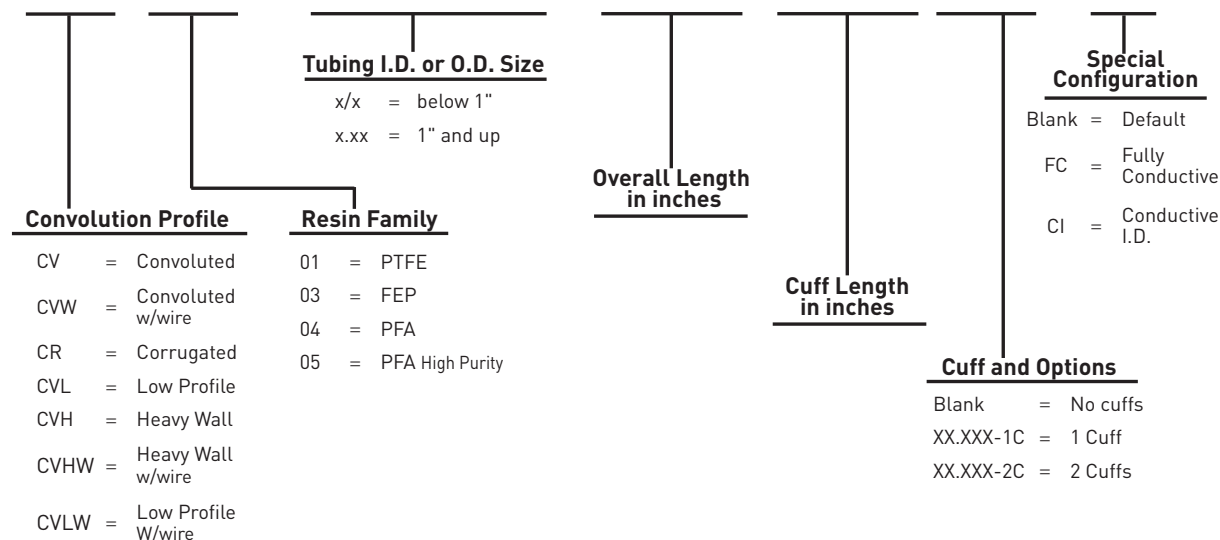

Tubing
Fluoropolymer

Coiled Air Hose
& Fittings

Transportation

Fittings

Tooling,
Equipment
& Accessories

General
Technical

Fluoropolymer Tubing

Fluoropolymer Tubing Nomenclature

Heat Shrink and Electrical Insulation Tubing

HS2**TF T 1/8 - NT***

Special Configurations	Resin Family	Tubing Configurations	Tubing Sizes**	Tube Packaging	Other Options	Configuration
Blank if Smooth Bore HS2 = 2:1 Ratio PTFE HS4 = 4:1 Ratio PTFE HS1.3 = 1.3/1:1 Ratio FEP HS1.6 = 1.67:1 Ratio FEP HS1.25 = 1.25:1 Ratio FEP	TF = PTFE FP = FEP PF = PFA ET = ETFE	H = Heavy Wall S = Standard Wall T = Thin Wall L = Light Wall I = Industrial Wall	XX for AWG size 0-30 X/X for Fractional sizes 1/8 to 1.00 inch	T = Bulk Default Configuration C = Tube Cut Job (followed by cut length in inches -if cut, go to Other Options)	Blank = Not required xx.xxx = Add cut length in inches	Blank = No color C = Colored Solid Tube S = Colored Stripe on Tube

*When ordering coiled tubing in colors, the color code is always followed by TC; when ordering cut lengths, the color code is followed by CC...i.e., HS2TFT1/8-2TC ..i.e., HS1.3FEP24-0CC48.000

**This first configuration is only used for heat shrinkable tubing or spiral wrap. For example, electrical insulation tubing part number would read TFT-1/8-NT.

***When changing to cut length, replace the T with C and specify the length in inches. If this part was cut to 4 feet, part number would read TFT-1/8-NC48.000.

****Sizes for heat shrink designate the size of the heat shrink tube as stated by the applicable specification. The actual O.D. of the tubing does not always match the size. Review actual tables to see the true expanded dimension of the tube.

PTFE Tubing

Series Fractional & Metric: 101, 201



Features

- Virgin Polytetrafluoroethylene resin
- Chemically inert
- Lowest coefficient of friction
- Superior dielectric strength
- Exceptional heat resistance
- Self extinguishing
- Non-wetting
- Excellent flexlife
- Laser markable

Applications/Markets



- Cable Liner
- Electrical Insulation
- Oxygen Sensor
- Paint Transfer
- Gas Sampling
- Laboratory



Certifications/Compliance

- AMS 3653E
- VW1 and UL-83 (natural)
- FDA Compliant
- USP Class VI Compliant

Order Information

Example: 101-0188062-OTC-100

101-0188062-OTC-100 – **PTFE**

101-**0188062**-OTC-100 – **Tube O.D.** in inches (**3/16"**)

101-0188**062**-OTC-100 – **Tube Wall Thickness** in inches (**.062"**)

101-0188062-**OTC**-100 – **Black**

101-0188062-**OTC**-100 – **Bulk Tubing**

101-0188062-**OTC**-100 – **Solid Color Tube**

101-0188062-OTC-**100** – **Package Quantity** in feet (**100'**)

Fittings

Fittings available for sizes 3/32" up to 1.1"

Parker Fittings available from:
Fluid System Connectors Division
Otsego, MI

(269) 692-6555

(269) 692-6634 FAX

FSC Product Families:

- Compression
- Compress-Align®
- Metric Compression
- TrueSeal™

Notes

- Working Temperature: -100°F (-73°C) to +500°F (260°C)
- Working pressure calculated using a Design Factor of 4
- Custom packaging and sizes are quoted upon request

Colors

- ○ Natural, Translucent
- Colors available as custom run, see color code table

Color Code					
○	N	Natural	●	5	Green
●	0	Black	●	6	Blue
●	1	Brown	●	7	Violet
●	2	Red	●	8	Gray
●	3	Orange	○	9	White
●	4	Yellow			



WARNING

This product can expose you to chemicals including Tetrafluoroethylene, which is known to the State of California to cause cancer. For more information go to www.P65Warnings.ca.gov.

101 PTFE Industrial Wall Fractional Size Tubing

Part Number	Order Size	Nominal O.D.				Nominal I.D.				Reference Wall		Working Pressure		Burst Pressure		Min. Bend Radius		Vac. Rating	Weight	
		inch	inch	tol.	mm	tol.	inch	tol.	mm	tol.	inch	mm	psi 73°F	bar 23°C	psi 73°F	bar 23°C	inch		mm	at 73°F
#																				
101-0094031	3/32	0.094	±0.005	2.40	±0.13	0.031	±0.002	0.79	±0.05	0.031	0.79	390	27	1560	108	0.500	13	28	0.006	0.009
101-0125031	1/8	0.125	±0.005	3.18	±0.13	0.063	±0.003	1.57	±0.05	0.031	0.79	290	20	1160	80	0.500	13	28	0.009	0.013
101-0156031	5/32	0.156	±0.005	3.99	±0.13	0.094	±0.004	2.39	±0.08	0.031	0.79	220	15	880	61	0.625	16	28	0.011	0.016
101-0188031	3/16	0.188	±0.005	4.78	±0.13	0.125	±0.005	3.18	±0.13	0.031	0.79	180	12	720	50	0.750	19	28	0.014	0.021
101-0250031	1/4	0.250	±0.005	6.35	±0.13	0.190	±0.005	4.83	±0.13	0.031	0.79	130	9	520	36	1.000	25	28	0.020	0.030
101-0312031	5/16	0.312	±0.005	7.92	±0.13	0.250	±0.007	6.35	±0.18	0.031	0.79	100	7	400	28	2.250	57	28	0.026	0.039
101-0375031	3/8	0.375	±0.005	9.52	±0.13	0.312	±0.006	7.92	±0.15	0.031	0.79	80	6	320	22	2.750	70	28	0.032	0.048
101-0438031	7/16	0.438	±0.005	11.13	±0.13	0.375	±0.007	9.52	±0.18	0.031	0.79	70	5	280	19	4.000	102	28	0.037	0.055
101-0500031	1/2	0.500	±0.006	12.70	±0.15	0.438	±0.008	11.13	±0.20	0.031	0.79	60	4	240	17	4.000	102	28	0.043	0.064
101-0563031	9/16	0.563	±0.007	14.30	±0.18	0.500	±0.010	12.70	±0.25	0.031	0.79	55	4	220	15	5.000	127	28	0.049	0.073
101-0625031	5/8	0.625	±0.007	15.88	±0.18	0.563	±0.010	14.30	±0.25	0.031	0.79	50	3	200	14	5.500	140	28	0.054	0.080
101-0688031	11/16	0.688	±0.010	17.48	±0.25	0.625	±0.012	15.88	±0.31	0.031	0.79	45	3	180	12	6.250	159	28	0.060	0.089
101-0750032	3/4	0.750	±0.010	19.05	±0.25	0.688	±0.012	17.48	±0.31	0.032	0.81	40	3	160	11	6.500	165	28	0.068	0.101
101-0830040	0.830	0.830	±0.014	21.08	±0.36	0.750	±0.014	19.05	±0.36	0.040	1.02	45	3	180	12	8.000	203	28	0.093	0.138
101-0965045	0.965	0.965	±0.016	24.51	±0.41	0.875	±0.016	22.22	±0.41	0.045	1.14	45	3	180	12	12.000	305	28	0.122	0.182
101-1100050	1.100	1.100	±0.020	27.94	±0.51	1.000	±0.020	25.40	±0.51	0.050	1.27	40	3	160	11	18.000	457	28	0.155	0.231

Continued on next page

PTFE Tubing (Series 101, 201) Maximum Working Pressure (bar)

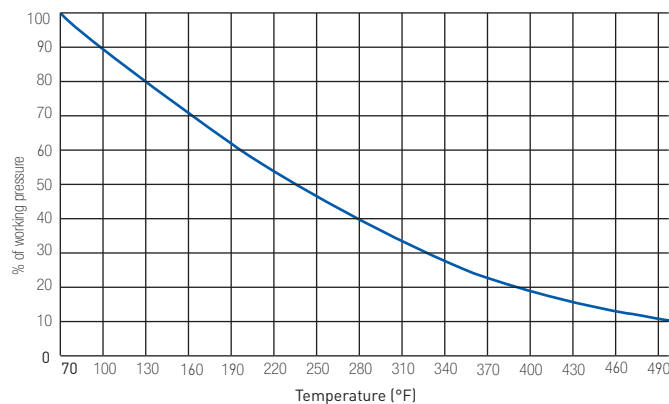

WARNING

This product can expose you to chemicals including Tetrafluoroethylene, which is known to the State of California to cause cancer. For more information go to www.P65Warnings.ca.gov.

PTFE Tubing

Series Fractional & Metric: 101, 201 (cont.)

101 PTFE Heavy Wall Fractional Size Tubing

Part Number	Order Size	Nominal O.D.				Nominal I.D.				Reference Wall		Working Pressure		Burst Pressure		Min. Bend Radius		Vac. Rating	Weight	
		inch	inch	tol.	mm	tol.	inch	tol.	mm	tol.	inch	mm	psi 73°F	bar 23°C	psi 73°F	bar 23°C	inch		mm	at 73°F
#																				
101-0188062	3/16	.188	±.005	4.78	±0.13	0.063	±0.003	1.57	±0.05	0.062	1.57	390	27	1560	108	0.250	6	28	0.023	0.034
101-0250047	1/4	.250	±.005	6.35	±0.13	0.157	±0.005	3.99	±0.13	0.047	1.19	210	14	840	58	0.625	16	28	0.028	0.042
101-0250062	1/4	.250	±.005	6.35	±0.13	0.125	±0.005	3.18	±0.13	0.062	1.57	290	20	1160	80	0.500	13	28	0.034	0.051
101-0312062	5/16	.312	±.005	7.92	±0.13	0.188	±0.006	4.76	±0.15	0.062	1.57	222	15	888	61	0.875	22	28	0.046	0.068
101-0375062	3/8	.375	±.005	9.52	±0.13	0.250	±0.005	6.35	±0.13	0.062	1.57	180	12	720	50	1.000	25	28	0.057	0.085
101-0438062	7/16	.438	±.005	11.13	±0.13	0.312	±0.007	7.92	±0.18	0.062	1.57	150	10	600	41	2.250	57	28	0.069	0.103
101-0500062	1/2	.500	±.005	12.70	±0.13	0.375	±0.005	9.52	±0.13	0.062	1.57	130	9	520	36	2.250	57	28	0.080	0.119
101-0563062	9/16	.563	±.007	14.30	±0.18	0.437	±0.008	11.13	±0.20	0.062	1.57	110	8	440	30	2.750	70	28	0.092	0.137
101-0625062	5/8	.625	±.007	15.88	±0.18	0.500	±0.010	12.70	±0.25	0.062	1.57	100	7	400	28	3.000	76	28	0.103	0.153
101-0688062	11/16	.688	±.010	17.48	±0.25	0.563	±0.010	14.30	±0.25	0.062	1.57	90	6	360	25	5.000	127	28	0.115	0.171
101-0750062	3/4	.750	±.010	19.05	±0.25	0.625	±0.010	15.88	±0.25	0.062	1.57	80	6	320	22	6.000	152	28	0.126	0.188
101-0875062	7/8	.875	±.014	22.22	±0.36	0.750	±0.014	19.05	±0.36	0.062	1.57	70	5	280	19	7.250	184	28	0.149	0.222
101-1000062	1	1.000	±.016	25.40	±0.25	0.875	±0.016	22.22	±0.36	0.062	1.57	100	6.9	400	28	8.000	203	28	0.172	0.256



WARNING

This product can expose you to chemicals including Tetrafluoroethylene, which is known to the State of California to cause cancer. For more information go to www.P65Warnings.ca.gov.

201 Metric PTFE Tubing

Part Number	Order Size		Nominal O.D.			Nominal I.D.				Reference Wall		Working Pressure		Burst Pressure		Min. Bend Radius		Vac. Rating		Weight	
	mm	inch	mm	inch	tol.	mm	inch	tol.	mm	inch	mm	inch	bar	psi	bar	psi	mm	inch	at	kg.	lb.
201-0300100	3	3	±0.11	0.118	±0.004	1	±0.11	0.039	±0.004	1	0.039	27	390	108	1560	13	0.500	28	0.014	0.009	
201-0400100	4	4	±0.11	0.157	±0.004	2	±0.11	0.074	±0.004	1	0.039	20	290	80	1160	13	0.500	28	0.020	0.014	
201-0500100	5	5	±0.11	0.197	±0.004	3	±0.11	0.118	±0.004	1	0.039	15	220	61	880	19	0.750	28	0.027	0.018	
201-0600100	6	6	±0.13	0.236	±0.005	4	±0.13	0.157	±0.005	1	0.039	12	180	50	720	25	1.000	28	0.034	0.023	
201-0700100	7	7	±0.13	0.276	±0.005	5	±0.13	0.197	±0.005	1	0.039	10	150	41	600	38	1.500	28	0.041	0.027	
201-0800100	8	8	±0.13	0.315	±0.005	6	±0.13	0.236	±0.005	1	0.039	9	130	36	520	51	2.000	28	0.048	0.032	
201-0900100	9	9	±0.13	0.354	±0.005	7	±0.13	0.276	±0.005	1	0.039	8	110	30	440	57	2.250	28	0.055	0.037	
201-1000100	10	10	±0.13	0.394	±0.005	8	±0.13	0.315	±0.005	1	0.039	7	100	28	400	64	2.500	28	0.061	0.041	
201-1200100	12	12	±0.15	0.472	±0.006	10	±0.15	0.394	±0.006	1	0.039	6	80	22	320	76	3.000	28	0.075	0.050	
201-1400100	14	14	±0.15	0.551	±0.006	12	±0.15	0.472	±0.006	1	0.039	5	70	19	280	89	3.500	28	0.089	0.060	
201-1600100	16	16	±0.15	0.630	±0.006	14	±0.15	0.551	±0.006	1	0.039	4	60	17	240	108	4.250	28	0.102	0.069	



WARNING

This product can expose you to chemicals including Tetrafluoroethylene, which is known to the State of California to cause cancer. For more information go to www.P65Warnings.ca.gov.

PTFE Tubing

Series Fractional: TFL, TFS, TFT



Features

- Virgin Polytetrafluoroethylene resin
- Chemically inert
- Lowest coefficient of friction
- Superior dielectric strength
- Exceptional heat resistance
- Self extinguishing
- Non-wetting
- Excellent flexlife
- Laser markable

Applications/Markets



- Electrical Insulation
- Protective Cover
- Cable Liner
- Spacer

Certifications/Compliance

- AMS 3653E
- VW1 and UL-83 (natural)
- FDA Compliant
- USP Class VI Compliant
- **Light Wall** (TFL) – ASTM D3295 Class 1
- **Thin Wall** (TFT) – ASTM D3295 Class 2, AMS 3655B
- **Standard Wall** (TFS) – ASTM D3295 Class 3, MIL-I-22129C

Order Information

Example: TFS1/2-NT

TFS1/2-NT – PTFE

TFS1/2-NT – Standard Wall

TFS1/2-NT – Tube O.D. in inches (1/2")

TFS1/2-NT – Natural

TFS1/2-NT – Bulk Tubing

Fittings

Fittings available for sizes 3/32" up to 1.1"

Parker Fittings available from:
Fluid System Connectors Division
Otsego, MI

(269) 692-6555

(269) 692-6634 FAX

FSC Product Families:

- TrueSeal™

Notes

- Working Temperature: -100°F (-73°C) to +500°F (260°C)
- Fractional tubing is supplied in random length coils
- Custom packaging, sizes and lengths are quoted upon request

Colors

- ○ Natural, Translucent
- Colors available as custom run, see color code table





Color Code					
○	N	Natural	●	5	Green
●	0	Black	●	6	Blue
●	1	Brown	●	7	Violet
●	2	Red	●	8	Gray
●	3	Orange	○	9	White
●	4	Yellow			



WARNING

This product can expose you to chemicals including Tetrafluoroethylene, which is known to the State of California to cause cancer. For more information go to www.P65Warnings.ca.gov.

TFS, TFT & TFL PTFE Fractional Tubing

Size	Nominal I.D.		Standard Wall			Thin Wall			Light Wall			Standard Packaging
			Part Number	Nominal Wall		Part Number	Nominal Wall		Part Number	Nominal Wall		
			#			#			#			
inch	inch	mm	Natural	inch	mm	Natural	inch	mm	Natural	inch	mm	
1/8	0.125	3.18	TFS1/8	0.020	0.51	TFT1/8	0.015	0.38	TFL1/8	0.008	0.20	Random Length Coil
3/16	0.188	4.78	TFS3/16	0.020	0.51	TFT3/16	0.015	0.38	TFL3/16	0.010	0.25	Random Length Coil
1/4	0.250	6.35	TFS1/4	0.020	0.51	TFT1/4	0.015	0.38	TFL1/4	0.010	0.25	Random Length Coil
5/16	0.318	7.92	TFS5/16	0.020	0.51	TFT5/16	0.015	0.38	TFL5/16	0.012	0.30	Random Length Coil
3/8	0.381	9.52	TFS3/8	0.025	0.64	TFT3/8	0.015	0.38	TFL3/8	0.015	0.38	Random Length Coil
7/16	0.444	11.13	TFS7/16	0.025	0.64	TFT7/16	0.018	0.46	TFL7/16	0.018	0.46	Random Length Coil
1/2	0.507	12.70	TFS1/2	0.025	0.64	TFT1/2	0.018	0.46	TFL1/2	0.018	0.46	Random Length Coil
5/8	0.632	15.88	TFS5/8	0.025	0.64	TFT5/8	0.020	0.51	-	-	-	Random Length Coil
3/4	0.760	19.05	TFS3/4	0.030	0.76	TFT3/4	0.025	0.64	-	-	-	Random Length Coil
7/8	0.885	22.22	TFS7/8	0.035	0.89	-	-	-	-	-	-	Random Length Coil
1	1.010	25.40	TFS1.00	0.035	0.89	-	-	-	-	-	-	Random Length Coil

 **WARNING** This product can expose you to chemicals including Tetrafluoroethylene, which is known to the State of California to cause cancer. For more information go to www.P65Warnings.ca.gov.

PTFE Tubing

Series AWG: TFH, TFS, TFT, TFL



Features

- Virgin Polytetrafluoroethylene resin
- Chemically inert
- Lowest coefficient of friction
- Superior dielectric strength
- Exceptional heat resistance
- Self extinguishing
- Non-wetting
- Excellent flexlife
- Laser markable

Applications/Markets



- Electrical Insulation
- Protective Cover
- Circuit Board
- Wire Insulation
- Strain Relief
- Introducer
- Stent Delivery



Certifications/Compliance

- AMS 3653E
- VW1 and UL-83 (natural)
- FDA Compliant
- USP Class VI Compliant
- **Light Wall** (TFL) – ASTM D3295 Class 1, UL-224 150V 200°C
- **Thin Wall** (TFT) – ASTM D3295 Class 2, AMS 3655B, UL-224 300V 200°C, CSA 9032-01 300V
- **Standard Wall** (TFS) – ASTM D3295 Class 3, MIL-I-22129C, UL-224 600V 200°C, CSA 9032-01 600V
- **Heavy Wall** (TFH) – ASTM D3295, Class 4

Order Information

Example: TFH13-2TC

TFH13-2TC – **PTFE**

TFH**13**-2TC – **Heavy Wall**

TFH**13**-2TC – **AWG Size**

TFH13-**2TC** – **Red**

TFH13-2TC – **Bulk Tubing**

TFH13-2TC – **Solid Color Tube**

Colors

- ○ Natural, Translucent
- Colors available as custom run, see color code table

Color Code					
○	N	Natural	●	5	Green
●	0	Black	●	6	Blue
●	1	Brown	●	7	Violet
●	2	Red	●	8	Gray
●	3	Orange	○	9	White
●	4	Yellow			

Notes

- Working Temperature: -100°F (-73°C) to +500°F (260°C)
- AWG Spaghetti tubing is supplied in random lengths
- Continuous lengths and colors quoted upon request
- Consult factory for pricing and minimum lengths



WARNING

This product can expose you to chemicals including Tetrafluoroethylene, which is known to the State of California to cause cancer. For more information go to www.P65Warnings.ca.gov.

TFH PTFE AWG Heavy Wall

Part Number	Order Size	Nominal I.D.		Minimum I.D.		Maximum I.D.		Nominal Wall		Standard Packaging
#		⊙		⊙		⊙		⊙		
	AWG	inch	mm	inch	mm	inch	mm	inch	mm	
TFH24	24	0.022	0.56	0.020	0.51	0.026	0.66	0.016 ± 0.003	0.41 ± 0.08	1,000 ft. Spool
TFH23	23	0.026	0.66	0.023	0.58	0.029	0.74	0.016 ± 0.003	0.41 ± 0.08	1,000 ft. Spool
TFH22	22	0.028	0.71	0.025	0.64	0.032	0.81	0.016 ± 0.003	0.41 ± 0.08	1,000 ft. Spool
TFH21	21	0.032	0.81	0.029	0.74	0.035	0.89	0.016 ± 0.003	0.41 ± 0.08	1,000 ft. Spool
TFH20	20	0.034	0.86	0.032	0.81	0.040	1.02	0.018 ± 0.003	0.46 ± 0.08	1,000 ft. Spool
TFH19	19	0.038	0.97	0.036	0.91	0.044	1.12	0.020 ± 0.004	0.51 ± 0.10	1,000 ft. Spool
TFH18	18	0.042	1.07	0.040	1.02	0.049	1.25	0.020 ± 0.004	0.51 ± 0.10	1,000 ft. Spool
TFH17	17	0.048	1.22	0.045	1.14	0.054	1.37	0.020 ± 0.004	0.51 ± 0.10	1,000 ft. Spool
TFH16	16	0.053	1.35	0.051	1.30	0.061	1.55	0.020 ± 0.004	0.51 ± 0.10	1,000 ft. Spool
TFH15	15	0.059	1.50	0.057	1.45	0.067	1.70	0.020 ± 0.004	0.51 ± 0.10	1,000 ft. Spool
TFH14	14	0.066	1.68	0.064	1.63	0.074	1.88	0.020 ± 0.004	0.51 ± 0.10	500 ft. Spool
TFH13	13	0.076	1.93	0.072	1.83	0.082	2.08	0.020 ± 0.004	0.51 ± 0.10	500 ft. Spool
TFH12	12	0.085	2.16	0.081	2.06	0.091	2.31	0.020 ± 0.004	0.51 ± 0.10	500 ft. Spool
TFH11	11	0.095	2.41	0.091	2.31	0.101	2.57	0.020 ± 0.004	0.51 ± 0.10	500 ft. Spool
TFH10	10	0.106	2.69	0.102	2.59	0.112	2.84	0.025 ± 0.005	0.64 ± 0.13	500 ft. Spool
TFH09	9	0.118	3.00	0.114	2.90	0.124	3.15	0.025 ± 0.005	0.64 ± 0.13	500 ft. Spool
TFH08	8	0.133	3.38	0.129	3.28	0.141	3.58	0.030 ± 0.005	0.76 ± 0.13	Random Length Coil
TFH07	7	0.148	3.76	0.144	3.66	0.158	4.01	0.030 ± 0.005	0.76 ± 0.13	Random Length Coil
TFH06	6	0.166	4.22	0.162	4.11	0.178	4.52	0.030 ± 0.005	0.76 ± 0.13	Random Length Coil
TFH05	5	0.185	4.70	0.182	4.62	0.196	4.98	0.032 ± 0.005	0.81 ± 0.13	Random Length Coil

TFL PTFE AWG Light Wall

Part Number	Order Size	Nominal I.D.		Minimum I.D.		Maximum I.D.		Nominal Wall		Standard Packaging
#		⊙		⊙		⊙		⊙		
	AWG	inch	mm	inch	mm	inch	mm	inch	mm	
TFL32	32	0.01	0.25	0.008	0.2	0.012	0.31	0.005 ± 0.002	0.13 ± 0.05	1,000 ft. Spool Only
TFL30	30	0.012	0.31	0.010	0.25	0.015	0.38	0.006 ± 0.002	0.13 ± 0.05	1,000 ft. Spool
TFL28	28	0.015	0.38	0.013	0.33	0.018	0.46	0.006 ± 0.002	0.13 ± 0.05	1,000 ft. Spool
TFL26	26	0.018	0.46	0.016	0.41	0.022	0.56	0.006 ± 0.002	0.13 ± 0.05	1,000 ft. Spool
TFL24	24	0.022	0.56	0.020	0.51	0.026	0.66	0.006 ± 0.002	0.13 ± 0.05	1,000 ft. Spool
TFL23	23	0.026	0.66	0.023	0.58	0.029	0.74	0.006 ± 0.002	0.13 ± 0.05	1,000 ft. Spool
TFL22	22	0.028	0.71	0.025	0.64	0.032	0.81	0.006 ± 0.002	0.13 ± 0.05	1,000 ft. Spool
TFL21	21	0.032	0.81	0.029	0.74	0.035	0.89	0.006 ± 0.002	0.13 ± 0.05	1,000 ft. Spool
TFL20	20	0.034	0.86	0.032	0.81	0.04	1.02	0.006 ± 0.002	0.13 ± 0.05	1,000 ft. Spool
TFL19	19	0.038	0.97	0.036	0.91	0.044	1.12	0.006 ± 0.002	0.13 ± 0.05	1,000 ft. Spool
TFL18	18	0.042	1.07	0.040	1.02	0.049	1.25	0.006 ± 0.002	0.13 ± 0.05	1,000 ft. Spool
TFL17	17	0.048	1.22	0.045	1.14	0.054	1.37	0.006 ± 0.002	0.13 ± 0.05	1,000 ft. Spool
TFL16	16	0.053	1.35	0.051	1.3	0.061	1.55	0.006 ± 0.002	0.13 ± 0.05	1,000 ft. Spool
TFL15	15	0.059	1.50	0.057	1.45	0.067	1.70	0.006 ± 0.002	0.13 ± 0.05	1,000 ft. Spool
TFL14	14	0.066	1.68	0.064	1.63	0.074	1.88	0.008 ± 0.002	0.20 ± 0.05	500 ft. Spool
TFL13	13	0.076	1.93	0.072	1.83	0.082	2.08	0.008 ± 0.002	0.20 ± 0.05	500 ft. Spool
TFL12	12	0.085	2.16	0.081	2.06	0.091	2.31	0.008 ± 0.002	0.20 ± 0.05	500 ft. Spool
TFL11	11	0.095	2.41	0.091	2.31	0.101	2.57	0.008 ± 0.002	0.20 ± 0.05	500 ft. Spool
TFL10	10	0.106	2.69	0.102	2.59	0.112	2.84	0.008 ± 0.002	0.20 ± 0.05	500 ft. Spool
TFL09	9	0.118	3.00	0.114	2.9	0.124	3.15	0.008 ± 0.002	0.20 ± 0.05	500 ft. Spool
TFL08	8	0.133	3.38	0.129	3.28	0.141	3.58	0.008 ± 0.002	0.20 ± 0.05	Random Length Coil
TFL07	7	0.148	3.76	0.144	3.66	0.158	4.01	0.008 ± 0.002	0.20 ± 0.05	Random Length Coil
TFL06	6	0.166	4.22	0.162	4.11	0.178	4.52	0.010 ± 0.003	0.25 ± 0.08	Random Length Coil
TFL05	5	0.185	4.70	0.182	4.62	0.196	4.98	0.010 ± 0.003	0.25 ± 0.08	Random Length Coil
TFL04	4	0.208	5.28	0.204	5.18	0.224	5.69	0.010 ± 0.003	0.25 ± 0.08	Random Length Coil
TFL03	3	0.234	5.94	0.229	5.82	0.249	6.32	0.010 ± 0.003	0.25 ± 0.08	Random Length Coil
TFL02	2	0.263	6.68	0.258	6.55	0.278	7.06	0.010 ± 0.003	0.25 ± 0.08	Random Length Coil
TFL01	1	0.294	7.47	0.289	7.34	0.311	7.90	0.012 ± 0.003	0.31 ± 0.08	Random Length Coil
TFL00	0	0.33	8.38	0.325	8.25	0.347	8.81	0.012 ± 0.003	0.31 ± 0.08	Random Length Coil



WARNING

This product can expose you to chemicals including Tetrafluoroethylene, which is known to the State of California to cause cancer. For more information go to www.P65Warnings.ca.gov.

Certifications/ Compliance

- ASTM D3295 Class 4
- AMS 3653E
- FDA Compliant
- USP Class VI Compliant

Certifications/ Compliance

- ASTM D3295 Class 1
- AMS 3653E
- UL-224 150V 200°C
- FDA Compliant
- USP Class VI Compliant

A Hose

D Tubing Fluoropolymer

C Coiled Air Hose & Fittings

D Transportation

F Fittings

T Tooling, Equipment & Accessories

G General Technical

PTFE Tubing

Series AWG: TFH, TFL, TFS, TFT (cont.)

TFS PTFE AWG Standard Wall

Part Number	Order Size	Nominal I.D.		Minimum I.D.		Maximum I.D.		Nominal Wall		Standard Packaging
#		⊙		⊙		⊙		⊙		
	AWG	inch	mm	inch	mm	inch	mm	inch	mm	
TFS30	30	0.012	0.31	0.010	0.25	0.015	0.38	.009 ± .002	0.23 ± 0.05	1,000 ft. Spool
TFS28	28	0.015	0.38	0.013	0.33	0.018	0.46	.009 ± .002	0.23 ± 0.05	1,000 ft. Spool
TFS26	26	0.018	0.46	0.016	0.41	0.022	0.56	.009 ± .002	0.23 ± 0.05	1,000 ft. Spool
TFS24	24	0.022	0.56	0.020	0.51	0.026	0.66	.012 ± .003	0.31 ± 0.08	1,000 ft. Spool
TFS23	23	0.026	0.66	0.023	0.58	0.029	0.74	.012 ± .003	0.31 ± 0.08	1,000 ft. Spool
TFS22	22	0.028	0.71	0.025	0.64	0.032	0.81	.012 ± .003	0.31 ± 0.08	1,000 ft. Spool
TFS21	21	0.032	0.81	0.029	0.74	0.035	0.89	.012 ± .003	0.31 ± 0.08	1,000 ft. Spool
TFS20	20	0.034	0.86	0.032	0.81	0.040	1.02	.016 ± .003	0.41 ± 0.08	1,000 ft. Spool
TFS19	19	0.038	0.97	0.036	0.91	0.044	1.12	.016 ± .003	0.41 ± 0.08	1,000 ft. Spool
TFS18	18	0.042	1.07	0.040	1.02	0.049	1.25	.016 ± .003	0.41 ± 0.08	1,000 ft. Spool
TFS17	17	0.048	1.22	0.045	1.14	0.054	1.37	.016 ± .003	0.41 ± 0.08	1,000 ft. Spool
TFS16	16	0.053	1.35	0.051	1.30	0.061	1.55	.016 ± .003	0.41 ± 0.08	1,000 ft. Spool
TFS15	15	0.059	1.50	0.057	1.45	0.067	1.70	.016 ± .003	0.41 ± 0.08	500 ft. Spool
TFS14	14	0.066	1.68	0.064	1.63	0.074	1.88	.016 ± .003	0.41 ± 0.08	500 ft. Spool
TFS13	13	0.076	1.93	0.072	1.83	0.082	2.08	.016 ± .003	0.41 ± 0.08	500 ft. Spool
TFS12	12	0.085	2.16	0.081	2.06	0.091	2.31	.016 ± .003	0.41 ± 0.08	500 ft. Spool
TFS11	11	0.095	2.41	0.091	2.31	0.101	2.57	.016 ± .003	0.41 ± 0.08	500 ft. Spool
TFS10	10	0.106	2.69	0.102	2.59	0.112	2.84	.016 ± .003	0.41 ± 0.08	500 ft. Spool
TFS09	9	0.118	3.00	0.114	2.90	0.124	3.15	.020 ± .004	0.51 ± 0.10	Random Length Coil
TFS08	8	0.133	3.38	0.129	3.28	0.141	3.58	.020 ± .004	0.51 ± 0.10	Random Length Coil
TFS07	7	0.148	3.76	0.144	3.66	0.158	4.01	.020 ± .004	0.51 ± 0.10	Random Length Coil
TFS06	6	0.166	4.22	0.162	4.11	0.178	4.52	.020 ± .004	0.51 ± 0.10	Random Length Coil
TFS05	5	0.185	4.70	0.182	4.62	0.196	4.98	.020 ± .004	0.51 ± 0.10	Random Length Coil
TFS04	4	0.208	5.28	0.204	5.18	0.224	5.69	.020 ± .004	0.51 ± 0.10	Random Length Coil
TFS03	3	0.234	5.94	0.229	5.82	0.249	6.32	.020 ± .004	0.51 ± 0.10	Random Length Coil
TFS02	2	0.263	6.68	0.258	6.55	0.278	7.06	.020 ± .004	0.51 ± 0.10	Random Length Coil
TFS01	1	0.294	7.47	0.289	7.34	0.311	7.90	.020 ± .004	0.51 ± 0.10	Random Length Coil
TFS00	0	0.330	8.38	0.325	8.25	0.347	8.81	.020 ± .004	0.51 ± 0.10	Random Length Coil

Certifications/Compliance

- ASTM D3295 Class 3
- MIL-I-22129C
- AMS 3653E
- UL-224 600V 200°C
- CSA 9032-01 600V
- FDA Compliant



WARNING

This product can expose you to chemicals including Tetrafluoroethylene, which is known to the State of California to cause cancer. For more information go to www.P65Warnings.ca.gov.

TFL PTFE AWG Light Wall

Part Number	Order Size	Nominal I.D.		Minimum I.D.		Maximum I.D.		Nominal Wall		Standard Packaging
#		⊙		⊙		⊙		⊙		
	AWG	inch	mm	inch	mm	inch	mm	inch	mm	
TFT32	32	.010	0.25	.008	0.20	.012	0.31	0.007 ± 0.002	0.18 ± 0.05	1,000 ft. Spool Only
TFT30	30	.012	0.31	.010	0.25	.015	0.38	0.009 ± 0.002	0.23 ± 0.05	1,000 ft. Spool
TFT28	28	.015	0.38	.013	0.33	.018	0.46	0.009 ± 0.002	0.23 ± 0.05	1,000 ft. Spool
TFT26	26	.018	0.46	.016	0.41	.022	0.56	0.009 ± 0.002	0.23 ± 0.05	1,000 ft. Spool
TFT24	24	.022	0.56	.020	0.51	.026	0.66	0.010 ± 0.003	0.25 ± 0.08	1,000 ft. Spool
TFT23	23	.026	0.66	.023	0.58	.029	0.74	0.010 ± 0.003	0.25 ± 0.08	1,000 ft. Spool
TFT22	22	.028	0.71	.025	0.64	.032	0.81	0.010 ± 0.003	0.25 ± 0.08	1,000 ft. Spool
TFT21	21	.032	0.81	.029	0.74	.035	0.89	0.010 ± 0.003	0.25 ± 0.08	1,000 ft. Spool
TFT20	20	.034	0.86	.032	0.81	.040	1.02	0.012 ± 0.003	0.31 ± 0.08	1,000 ft. Spool
TFT19	19	.038	0.97	.036	0.91	.044	1.12	0.012 ± 0.003	0.31 ± 0.08	1,000 ft. Spool
TFT18	18	.042	1.07	.040	1.02	.049	1.25	0.012 ± 0.003	0.31 ± 0.08	1,000 ft. Spool
TFT17	17	.048	1.22	.045	1.14	.054	1.37	0.012 ± 0.003	0.31 ± 0.08	1,000 ft. Spool
TFT16	16	.053	1.35	.051	1.30	.061	1.55	0.012 ± 0.003	0.31 ± 0.08	1,000 ft. Spool
TFT15	15	.059	1.50	.057	1.45	.067	1.70	0.012 ± 0.003	0.31 ± 0.08	1,000 ft. Spool
TFT14	14	.066	1.68	.064	1.63	.074	1.88	0.012 ± 0.003	0.31 ± 0.08	500 ft. Spool
TFT13	13	.076	1.93	.072	1.83	.082	2.08	0.012 ± 0.003	0.31 ± 0.08	500 ft. Spool
TFT12	12	.085	2.16	.081	2.06	.091	2.31	0.012 ± 0.003	0.31 ± 0.08	500 ft. Spool
TFT11	11	.095	2.41	.091	2.31	.101	2.57	0.012 ± 0.003	0.31 ± 0.08	500 ft. Spool
TFT10	10	.106	2.69	.102	2.59	.112	2.84	0.012 ± 0.003	0.31 ± 0.08	500 ft. Spool
TFT09	9	.118	3.00	.114	2.90	.124	3.15	0.015 ± 0.003	0.38 ± 0.08	500 ft. Spool
TFT08	8	.133	3.38	.129	3.28	.141	3.58	0.015 ± 0.003	0.38 ± 0.08	Random Length Coil
TFT07	7	.148	3.76	.144	3.66	.158	4.01	0.015 ± 0.003	0.38 ± 0.08	Random Length Coil
TFT06	6	.166	4.22	.162	4.11	.178	4.52	0.015 ± 0.003	0.38 ± 0.08	Random Length Coil
TFT05	5	.185	4.70	.182	4.62	.196	4.98	0.015 ± 0.003	0.38 ± 0.08	Random Length Coil
TFT04	4	.208	5.28	.204	5.18	.224	5.69	0.015 ± 0.003	0.38 ± 0.08	Random Length Coil
TFT03	3	.234	5.94	.229	5.82	.249	6.32	0.015 ± 0.003	0.38 ± 0.08	Random Length Coil
TFT02	2	.263	6.68	.258	6.55	.278	7.06	0.015 ± 0.003	0.38 ± 0.08	Random Length Coil
TFT01	1	.294	7.47	.289	7.34	.311	7.90	0.015 ± 0.003	0.38 ± 0.08	Random Length Coil
TFT00	0	.330	8.38	.325	8.25	.347	8.81	0.015 ± 0.003	0.38 ± 0.08	Random Length Coil

Certifications/Compliance

- ASTM D3295 Class 2
- AMS 3653E
- AMS 3655B
- UL-224 300V 200°C
- CSA 9032-01 300V
- FDA Compliant
- USP Class VI Compliant

**WARNING**

This product can expose you to chemicals including Tetrafluoroethylene, which is known to the State of California to cause cancer. For more information go to www.P65Warnings.ca.gov.

PTFE Spiral Cut Cable Wrap

Series: TSWTF



Features

- Provides harnessing for wires and cable while allowing leads at various points
- Exceptional heat resistance
- Self extinguishing
- Flexible
- Superior dielectric strength

Certifications/Compliance

- AMS 3653E
- ASTM D3295
- VW1 and UL-83 (natural)

Applications/Markets



- Cable harnessing
- Wiring closets
- Aerospace
- Automotive

Order Information

Example: TSWTF-3/8-5T

TSWTF-3/8-5T – Spiral Wrap

TSWTF-3/8-5T – **Material (PTFE)**

TSWTF-3/8-5T – **O.D. in inches (.375")**

TSWTF-3/8-5T – **Green**

TSWTF-3/8-5T – **Bulk Tubing**

Colors

- ○ Natural, Translucent
- Colors available as custom run, see color code table

Color Code					
○	N	Natural	●	5	Green
●	0	Black	●	6	Blue
●	1	Brown	●	7	Violet
●	2	Red	●	8	Gray
●	3	Orange	○	9	White
●	4	Yellow			

Notes

- Available in left- or right-hand cut. Please specify with proper suffix at end of part number (i.e. TSWTF-18-NT-R)
- Working Temperature: 500°F (260°C)
- Custom packaging, sizes and colors are available upon request
- Colors available as custom run, see color code table



WARNING

This product can expose you to chemicals including Tetrafluoroethylene, which is known to the State of California to cause cancer. For more information go to www.P65Warnings.ca.gov.

PTFE Spiral Wrap

Part Number	O.D. "A"		tolerance O.D.		Wall "B"		tolerance Wall		Pitch "D"		tolerance Pitch		Max Bundle O.D. "C"	
	inch	mm	inch	mm	inch	mm	inch	mm	inch	mm	inch	mm	inch	mm
#														
TSWTF-1/8-NT	0.125	3.18	± 0.005	0.127	0.020	0.508	± 0.008	0.203	0.212	5.38	± 0.015	0.381	1/2	12.70
TSWTF-3/16-NT	0.188	4.78	± 0.005	0.127	0.030	0.762	± 0.008	0.203	0.312	7.92	± 0.015	0.381	1	25.40
TSWTF-1/4-NT	0.250	6.35	± 0.005	0.127	0.030	0.762	± 0.008	0.203	0.375	9.52	± 0.015	0.381	2	50.80
TSWTF-3/8-NT	0.375	9.52	± 0.005	0.127	0.030	0.762	± 0.008	0.203	0.437	11.10	± 0.015	0.381	2-1/2	63.50
TSWTF-1/2-NT	0.500	12.70	± 0.005	0.127	0.030	0.762	± 0.008	0.203	0.562	14.27	± 0.015	0.381	3	76.20
TSWTF-3/4-NT	0.750	19.05	± 0.005	0.127	0.040	1.02	± 0.008	0.203	0.875	22.22	± 0.015	0.381	4	101.60
TSWTF-1.00-NT	1	25.40	± 0.005	0.127	0.040	1.02	± 0.008	0.203	1	25.40	± 0.015	0.381	6	152.40

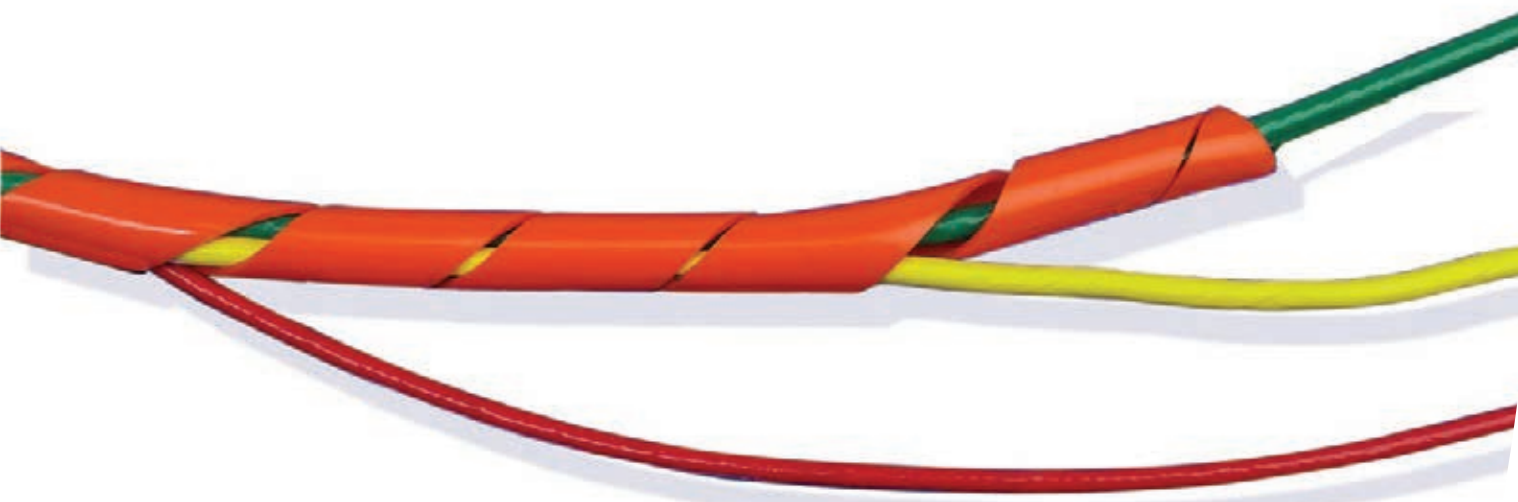
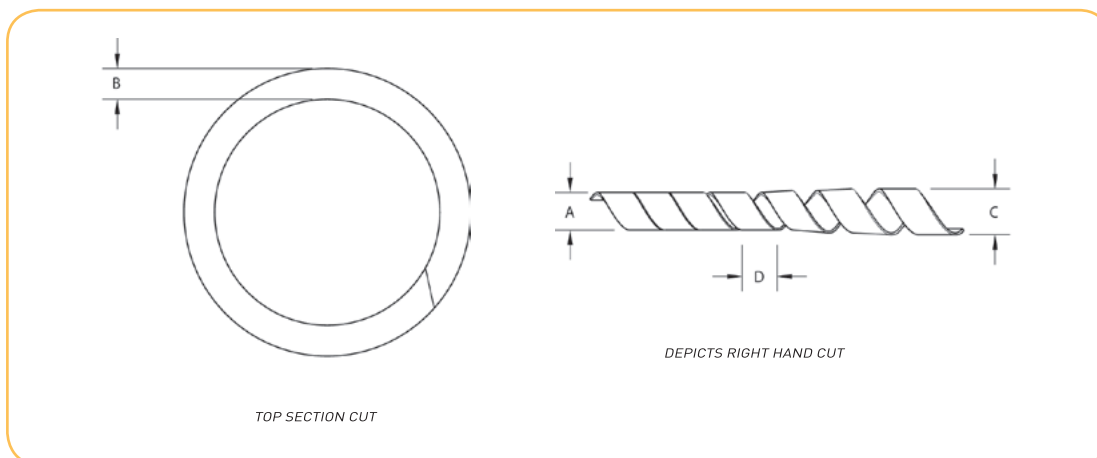

WARNING This product can expose you to chemicals including Tetrafluoroethylene, which is known to the State of California to cause cancer. For more information go to www.P65Warnings.ca.gov.

PTFE Heat Shrinkable Tubing

Series 2:1 Fractional: HS2TFS, HS2TFT, HS2TFL, HS2TFI



Features

- Virgin Polytetrafluoroethylene resin
- 2:1 Shrink Ratio
- Chemically inert
- Lowest coefficient of friction
- Superior dielectric strength
- Exceptional heat resistance
- Self extinguishing
- Non-wetting

Certifications/Compliance

- ASTM D2902 Type I
- AMS 3653E
- VW1 and UL-83 (natural)
- FDA Compliant
- USP Class VI Compliant
- **Light Wall** (HS2TFL) - AMS-DTL-23053/12A Class 4
- **Thin Wall** (HS2TFT) - AMS-DTL-23053/12A Class 3, AMS 3585
- **Standard Wall** (HS2TFS) - AMS-DTL-23053/12A Class 2, AMS 3586
- **Heavy Wall** (HS2TFH) - AMS-DTL-23053/12A Class 1 (Custom Order only)

Applications/Markets



- Electrical Insulation
- Protective Cover
- Electronic Harness
- Laboratory

Order Information

Example: HS2TFI7/8-NT

HS2TFI7/8-NT – Heat Shrink

HS2TFI7/8-NT – **Shrink Ratio (2:1)**

HS2TFI7/8-NT – **PTFE**

HS2TFI7/8-NT – **Wall Type (Industrial Wall)**

HS2TFI7/8-NT – **Heat Shrink Size** in inches (7/8")

HS2TFI7/8-NT – **Natural**

HS2TFI7/8-NT – **Bulk Tubing**

Colors

- ○ Natural, Opaque to translucent
- Colors available as custom run, see color code table

When ordering coiled tubing in colors, the color code is always followed by TC; when ordering cut lengths, the color code is followed by CC

i.e., HS2TFI7/8-2TC i.e., HS2TFI7/8-0CC48.000

Color Code					
○	N	Natural	●	5	Green
●	0	Black	●	6	Blue
●	1	Brown	●	7	Violet
●	2	Red	●	8	Gray
●	3	Orange	○	9	White
●	4	Yellow			

Notes

- Working Temperature: -100°F (-73°C) to +500°F (260°C)
- Shrink Temperature: 662°F (350°C) for 10 minutes per AMS-DTL-23053/12A
- *Dielectric Strength: ≥ 1,400 V/M, per ASTM D 149 short term test of 10 MIL thickness (Volts/MIL)
- PTFE Fractional Heat Shrink tubing is available in stock packaging of 4-ft. straight lengths
- Custom packaging, sizes, lengths and colors are quoted upon request



WARNING

This product can expose you to chemicals including Tetrafluoroethylene, which is known to the State of California to cause cancer. For more information go to www.P65Warnings.ca.gov.

HS2TFS & HS2TFT PTFE Fractional Heat Shrink Tubing (2:1) SW & TW

Order Size inch	Minimum Expanded I.D.		Maximum Recovered I.D.		Standard Wall				Thin Wall			
	inch	mm	inch	mm	Mil Spec*	Part Number	Nominal Recovered Wall		Mil Spec*	Part Number	Nominal Recovered Wall	
							inch	mm			inch	mm
1/8	0.215	05.5	0.130	3.3	23053/12A-215	HS2TFS1/8	0.020 ± 0.004	0.51 ± 0.10	23053/12A-319	HS2TFT1/8	0.015 ± 0.003	0.38 ± 0.08
1/4	0.410	10.4	0.260	6.6	23053/12A-222	HS2TFS1/4	0.020 ± 0.004	0.51 ± 0.10	23053/12A-326	HS2TFT1/4	0.015 ± 0.004	0.38 ± 0.10
5/16	0.470	11.9	0.329	8.4	23053/12A-225	HS2TFS5/16	0.020 ± 0.004	0.51 ± 0.10	23053/12A-329	HS2TFT5/16	0.015 ± 0.004	0.38 ± 0.10
3/8	0.560	14.2	0.399	10.1	23053/12A-228	HS2TFS3/8	0.025 ± 0.006	0.64 ± 0.15	-	HS2TF 3/8	0.015 ± 0.004	0.38 ± 0.10
7/16	0.655	16.6	0.462	11.7	23053/12A-229	HS2TFS7/16	0.025 ± 0.006	0.64 ± 0.15	-	HS2TFT7/16	0.018 ± 0.004	0.46 ± 0.10
1/2	0.750	19.1	0.524	13.3	23053/12A-230	HS2TFS1/2	0.025 ± 0.006	0.64 ± 0.15	-	HS2TFT1/2	0.018 ± 0.004	0.46 ± 0.10
5/8	0.930	23.6	0.655	16.6	23053/12A-231	HS2TFS5/8	0.030 ± 0.006	0.76 ± 0.15	-	HS2TF 5/8	0.020 ± 0.004	0.51 ± 0.10
3/4	1.125	28.6	0.786	20.0	23053/12A-232	HS2TFS3/4	0.035 ± 0.008	0.89 ± 0.20	-	HS2TFT3/4	0.025 ± 0.004	0.64 ± 0.10
7/8	1.130	28.7	0.911	23.1	23053/12A-233	HS2TFS7/8	0.035 ± 0.008	0.89 ± 0.20	-	HS2TFT7/8	0.025 ± 0.004	0.64 ± 0.10
1	1.500	38.1	1.036	26.3	23053/12A-234	HS2TFS1.00	0.035 ± 0.008	0.89 ± 0.20	-	HS2TFT1.00	0.025 ± 0.004	0.64 ± 0.10

HS2TFL PTFE Fractional Heat Shrink Tubing (2:1) LW

Order Size inch	Minimum Expanded I.D.		Maximum Recovered I.D.		Light Wall			
	inch	mm	inch	mm	Mil Spec*	Part Number	Nominal Recovered Wall	
							inch	mm
1/8	0.215	5.5	0.130	3.3	23053/12A-415	HS2TFL1/8	0.008 ± 0.002	0.20 ± 0.05
1/4	0.410	10.4	0.260	6.6	23053/12A-422	HS2TFL1/4	0.010 ± 0.003	0.25 ± 0.08
5/16	0.470	11.9	0.329	8.4	23053/12A-425	HS2TFL5/16	0.012 ± 0.003	0.31 ± 0.08

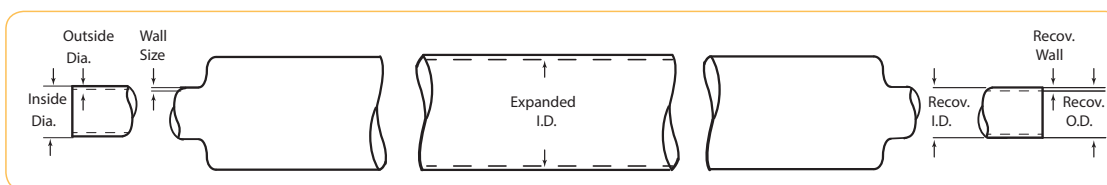

HS2TFI PTFE Fractional Heat Shrink Tubing (2:1), Ind. Heavy Wall

Part Number	Order Size inch	Mil Spec*	Minimum Expanded I.D.		Maximum Recovered I.D.		Nominal Recovered Wall	
			inch	mm	inch	mm	inch	mm
HS2TFI1/8	1/8	23053/12A-101	0.166	4.2	0.130	3.3	0.030 ± 0.005	0.76 ± 0.13
HS2TFI3/16	3/16	23053/12A-102	0.250	6.4	0.193	4.9	0.030 ± 0.005	0.76 ± 0.13
HS2TFI1/4	1/4	23053/12A-103	0.333	8.4	0.257	6.5	0.030 ± 0.005	0.76 ± 0.13
HS2TFI5/16	5/16	23053/12A-104	0.415	10.5	0.320	8.1	0.030 ± 0.005	0.76 ± 0.13
HS2TFI3/8	3/8	23053/12A-105	0.498	12.6	0.383	9.7	0.030 ± 0.005	0.76 ± 0.13
HS2TFI7/16	7/16	23053/12A-106	0.580	14.7	0.448	11.4	0.030 ± 0.006	0.76 ± 0.15
HS2TFI1/2	1/2	23053/12A-107	0.666	16.9	0.510	13.0	0.030 ± 0.006	0.76 ± 0.15
HS2TFI9/16	9/16	23053/12A-108	0.748	19.0	0.572	14.5	0.030 ± 0.006	0.76 ± 0.15
HS2TFI5/8	5/8	23053/12A-109	0.830	21.1	0.637	16.2	0.030 ± 0.006	0.76 ± 0.15
HS2TFI11/16	11/16	23053/12A-110	0.915	23.2	0.700	17.8	0.032 ± 0.006	0.81 ± 0.15
HS2TFI3/4	3/4	23053/12A-111	1.000	25.4	0.764	19.4	0.040 ± 0.007	1.02 ± 0.18
HS2TFI7/8	7/8	23053/12A-112	1.170	29.7	0.891	22.6	0.045 ± 0.007	1.14 ± 0.18
HS2TFI1.00	1	23053/12A-113	1.330	33.8	1.020	25.9	0.050 ± 0.008	1.27 ± 0.20



WARNING

This product can expose you to chemicals including Tetrafluoroethylene, which is known to the State of California to cause cancer. For more information go to www.P65Warnings.ca.gov.

PTFE Heat Shrinkable Tubing

Series 2:1 AWG: HS2TFS, HS2TFT, HS2TFL



Features

- Virgin Polytetrafluoroethylene resin
- 2:1 Shrink Ratio
- Chemically inert
- Lowest coefficient of friction
- Superior dielectric strength
- Exceptional heat resistance
- Self extinguishing
- Non-wetting

Certifications/Compliance

- ASTM D2902 Type I
- AMS 3653E
- VW1 and UL-83 (natural)
- FDA Compliant
- USP Class VI Compliant
- **Light Wall** (HS2TFL) - AMS-DTL-23053/12A Class 4
- **Thin Wall** (HS2TFT) - AMS-DTL-23053/12A Class 3, AMS 3585
- **Standard Wall** (HS2TFS) - AMS-DTL-23053/12A Class 2, AMS 3586
- **Heavy Wall** (HS2TFH) - AMS-DTL-23053/12A Class 1 (Custom Order only)

Applications/Markets



- Electrical Insulation
- Protective Cover
- Electronic Harness
- Laboratory

Order Information

Example: HS2TFS15-4TC-500

HS2TFS15-4TC-500 – Heat Shrink

HS2TFS15-4TC-500 – Shrink Ratio (2:1)

HS2TFS15-4TC-500 – PTFE

HS2TFS15-4TC-500 – Wall Type (Standard Wall)

HS2TFS15-4TC-500 – Heat Shrink Size in AWG (AWG15)

HS2TFS15-4TC-500 – Yellow

HS2TFS15-4TC-500 – Bulk Tubing

HS2TFS15-4TC-500 – Solid Color

HS2TFS15-4TC-500 – Package Quantity in feet (500')

Colors

- ○ Natural, Opaque to translucent
- Colors available as custom run, see color code table

When ordering coiled tubing in colors, the color code is always followed by TC; when ordering cut lengths, the color code is followed by CC

i.e., HS2TFS15-2TC i.e., HS2TFS15-0CC48.000

Color Code					
○	N	Natural	●	5	Green
●	0	Black	●	6	Blue
●	1	Brown	●	7	Violet
●	2	Red	●	8	Gray
●	3	Orange	○	9	White
●	4	Yellow			

Notes

- Working Temperature: -100°F (-73°C) to +500°F (260°C)
- Shrink Temperature: 662°F (350°C) for 10 minutes AMS-DTL-23053/12A
- *Dielectric Strength: ≥ 1,400 V/M, per ASTM D 149 short term test of 10 MIL thickness (Volts/MIL)
- PTFE AWG Heat Shrink tubing is available in stock packaging of 4-ft. straight lengths
- Custom packaging, sizes, lengths and colors are quoted upon request



WARNING

This product can expose you to chemicals including Tetrafluoroethylene, which is known to the State of California to cause cancer. For more information go to www.P65Warnings.ca.gov.

HS2TFS Standard Wall (2:1)

Part Number	Order Size AWG	Mil Spec*	Minimum Expanded I.D.		Maximum Recovered I.D.		Nominal Recovered Wall	
			inch	mm	inch	mm	inch	mm
HS2TFS24	24	23053/12A-201	0.050	1.27	0.027	0.69	0.012 ± 0.002	0.31 ± 0.05
HS2TFS22	22	23053/12A-202	0.055	1.40	0.032	0.81	0.012 ± 0.002	0.31 ± 0.05
HS2TFS20	20	23053/12A-203	0.060	1.52	0.039	0.99	0.016 ± 0.003	0.41 ± 0.08
HS2TFS19	19	23053/12A-204	0.065	1.65	0.043	1.09	0.016 ± 0.003	0.41 ± 0.08
HS2TFS18	18	23053/12A-205	0.076	1.93	0.049	1.25	0.016 ± 0.003	0.41 ± 0.08
HS2TFS17	17	23053/12A-206	0.085	2.16	0.054	1.37	0.016 ± 0.003	0.41 ± 0.08
HS2TFS16	16	-	0.093	2.36	0.061	1.55	0.016 ± 0.003	0.41 ± 0.08
HS2TFS15	15	23053/12A-207	0.110	2.79	0.067	1.70	0.016 ± 0.003	0.41 ± 0.08
HS2TFS14	14	23053/12A-208	0.120	3.05	0.072	1.83	0.016 ± 0.003	0.41 ± 0.08
HS2TFS13	13	23053/12A-210	0.140	3.56	0.080	2.03	0.016 ± 0.003	0.41 ± 0.08
HS2TFS12	12	23053/12A-211	0.150	3.81	0.089	2.26	0.016 ± 0.003	0.41 ± 0.08
HS2TFS11	11	23053/12A-212	0.170	4.32	0.101	2.57	0.016 ± 0.003	0.41 ± 0.08
HS2TFS10	10	23053/12A-213	0.191	4.85	0.112	2.84	0.016 ± 0.003	0.41 ± 0.08
HS2TFS09	9	23053/12A-214	0.205	5.21	0.124	3.15	0.020 ± 0.004	0.51 ± 0.10
HS2TFS08	8	23053/12A-216	0.240	6.10	0.141	3.58	0.020 ± 0.004	0.51 ± 0.10
HS2TFS07	7	23053/12A-217	0.270	6.86	0.158	4.01	0.020 ± 0.004	0.51 ± 0.10
HS2TFS06	6	23053/12A-218	0.302	7.67	0.178	4.52	0.020 ± 0.004	0.51 ± 0.10
HS2TFS05	5	23053/12A-219	0.320	8.13	0.198	5.03	0.020 ± 0.004	0.51 ± 0.10
HS2TFS04	4	23053/12A-220	0.370	9.40	0.224	5.69	0.020 ± 0.004	0.51 ± 0.10
HS2TFS03	3	23053/12A-221	0.390	9.91	0.249	6.32	0.020 ± 0.004	0.51 ± 0.10
HS2TFS02	2	23053/12A-223	0.430	10.9	0.278	7.06	0.020 ± 0.004	0.51 ± 0.10
HS2TFS01	1	23053/12A-224	0.450	11.4	0.311	7.90	0.020 ± 0.004	0.51 ± 0.10
HS2TFS00	0	23053/12A-226	0.470	11.9	0.347	8.81	0.020 ± 0.004	0.51 ± 0.10

Certifications/Compliance

- AMS-DTL-23053/12A, Class 3
- AMS 3585
- ASTM D2902 Type I
- FDA Compliant
- USP Class VI Compliant

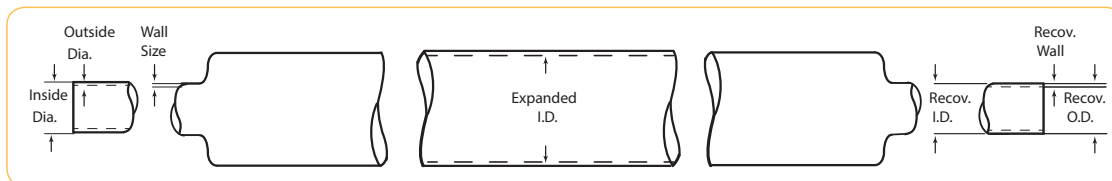

WARNING

This product can expose you to chemicals including Tetrafluoroethylene, which is known to the State of California to cause cancer. For more information go to www.P65Warnings.ca.gov.

PTFE Heat Shrinkable Tubing

Series 2:1 AWG: HS2TFS, HS2TFT, HS2TFL (cont.)

HS2TFT Thin Wall (2:1)

Part Number	Order Size AWG	Mil Spec**	Minimum Expanded I.D.		Maximum Recovered I.D.		Nominal Recovered Wall	
			inch	mm	inch	mm	inch	mm
HS2TFT30	30	23053/12A-301	0.034	0.86	0.015	0.38	0.009 ± 0.002	0.23 ± 0.05
HS2TFT28	28	23053/12A-302	0.038	0.97	0.018	0.46	0.009 ± 0.002	0.23 ± 0.05
HS2TFT26	26	23053/12A-303	0.046	1.16	0.022	0.56	0.010 ± 0.003	0.25 ± 0.08
HS2TFT24	24	23053/12A-304	0.050	1.27	0.027	0.69	0.010 ± 0.002	0.25 ± 0.08
HS2TFT22	22	23053/12A-305	0.055	1.40	0.032	0.81	0.012 ± 0.003	0.31 ± 0.08
HS2TFT20	20	23053/12A-306	0.060	1.52	0.039	0.99	0.012 ± 0.003	0.31 ± 0.08
HS2TFT19	19	23053/12A-307	0.065	1.65	0.043	1.09	0.012 ± 0.003	0.31 ± 0.08
HS2TFT18	18	23053/12A-308	0.076	1.93	0.049	1.25	0.012 ± 0.003	0.31 ± 0.08
HS2TFT17	17	23053/12A-309	0.085	2.16	0.054	1.37	0.012 ± 0.003	0.31 ± 0.08
HS2TFT16	16	23053/12A-310	0.093	2.36	0.061	1.55	0.012 ± 0.003	0.31 ± 0.08
HS2TFT15	15	23053/12A-311	0.110	2.79	0.067	1.70	0.012 ± 0.003	0.31 ± 0.08
HS2TFT14	14	23053/12A-312	0.120	3.05	0.072	1.83	0.012 ± 0.003	0.31 ± 0.08
HS2TFT13	13	23053/12A-313	0.140	3.56	0.080	2.03	0.012 ± 0.003	0.31 ± 0.08
HS2TFT12	12	23053/12A-314	0.150	3.81	0.089	2.26	0.012 ± 0.003	0.31 ± 0.08
HS2TFT11	11	23053/12A-316	0.170	4.32	0.101	2.57	0.012 ± 0.003	0.31 ± 0.08
HS2TFT10	10	23053/12A-317	0.191	4.85	0.112	2.84	0.012 ± 0.003	0.31 ± 0.08
HS2TFT09	9	23053/12A-318	0.205	5.21	0.124	3.15	0.015 ± 0.004	0.38 ± 0.10
HS2TFT08	8	23053/12A-320	0.240	6.10	0.141	3.58	0.015 ± 0.004	0.38 ± 0.10
HS2TFT07	7	23053/12A-321	0.270	6.86	0.158	4.01	0.015 ± 0.004	0.38 ± 0.10
HS2TFT06	6	23053/12A-322	0.302	7.67	0.178	4.52	0.015 ± 0.004	0.38 ± 0.10
HS2TFT05	5	23053/12A-323	0.320	8.13	0.198	5.03	0.015 ± 0.004	0.38 ± 0.10
HS2TFT04	4	23053/12A-324	0.370	9.40	0.224	5.69	0.015 ± 0.004	0.38 ± 0.10
HS2TFT03	3	23053/12A-325	0.390	9.91	0.249	6.32	0.015 ± 0.004	0.38 ± 0.10
HS2TFT02	2	23053/12A-327	0.430	10.9	0.278	7.06	0.015 ± 0.004	0.38 ± 0.10
HS2TFT01	1	23053/12A-328	0.450	11.4	0.311	7.90	0.015 ± 0.004	0.38 ± 0.10
HS2TFT00	0	23053/12A-330	0.470	11.9	0.347	8.81	0.015 ± 0.004	0.38 ± 0.10

*Dielectric Strength: ≥ 1,400 V/M, per ASTM D 149 short term test of 10 MIL thickness (Volts/MIL)

Certifications/Compliance

- AMS-DTL-23053/12A, Class 3
- AMS 3585
- ASTM D2902 Type I
- FDA Compliant
- USP Class VI Compliant



WARNING

This product can expose you to chemicals including Tetrafluoroethylene, which is known to the State of California to cause cancer. For more information go to www.P65Warnings.ca.gov.

HS2TFL Light Wall (2:1)

Part Number	Order Size AWG	Mil Spec**	Minimum Expanded I.D.		Maximum Recovered I.D.		Nominal Recovered Wall	
			inch	mm	inch	mm	inch	mm
HS2TFL24	24	23053/12A-404	0.050	1.27	0.025	0.64	0.006 ± 0.002	0.15 ± 0.05
HS2TFL22	22	23053/12A-405	0.055	1.40	0.031	0.79	0.006 ± 0.002	0.15 ± 0.05
HS2TFL20	20	23053/12A-406	0.060	1.52	0.038	0.97	0.006 ± 0.002	0.15 ± 0.05
HS2TFL19	19	23053/12A-407	0.065	1.65	0.043	1.09	0.006 ± 0.002	0.15 ± 0.05
HS2TFL18	18	23053/12A-408	0.076	1.93	0.046	1.17	0.006 ± 0.002	0.15 ± 0.05
HS2TFL17	17	23053/12A-409	0.085	2.16	0.054	1.37	0.006 ± 0.002	0.15 ± 0.05
HS2TFL16	16	23053/12A-410	0.093	2.36	0.057	1.45	0.006 ± 0.002	0.15 ± 0.05
HS2TFL15	15	23053/12A-411	0.110	2.79	0.063	1.60	0.006 ± 0.002	0.15 ± 0.05
HS2TFL14	14	23053/12A-412	0.120	3.05	0.072	1.83	0.008 ± 0.002	0.20 ± 0.05
HS2TFL13	13	23053/12A-413	0.140	3.56	0.080	2.03	0.008 ± 0.002	0.20 ± 0.05
HS2TFL12	12	23053/12A-414	0.150	3.81	0.089	2.26	0.008 ± 0.002	0.20 ± 0.05
HS2TFL11	11	23053/12A-416	0.170	4.32	0.099	2.51	0.008 ± 0.002	0.20 ± 0.05
HS2TFL10	10	23053/12A-417	0.191	4.85	0.110	2.79	0.008 ± 0.002	0.20 ± 0.05
HS2TFL09	9	23053/12A-418	0.205	5.21	0.122	3.10	0.008 ± 0.002	0.20 ± 0.05
HS2TFL08	8	23053/12A-420	0.240	6.10	0.139	3.53	0.008 ± 0.002	0.20 ± 0.05
HS2TFL07	7	23053/12A-421	0.270	6.86	0.154	3.91	0.008 ± 0.002	0.20 ± 0.05
HS2TFL06	6	23053/12A-422	0.302	7.67	0.172	4.37	0.010 ± 0.003	0.25 ± 0.08
HS2TFL05	5	23053/12A-423	0.320	8.13	0.192	4.88	0.010 ± 0.003	0.25 ± 0.08
HS2TFL04	4	23053/12A-424	0.370	9.40	0.214	5.44	0.010 ± 0.003	0.25 ± 0.08
HS2TFL03	3	23053/12A-425	0.390	9.91	0.241	6.12	0.010 ± 0.003	0.25 ± 0.08
HS2TFL02	2	23053/12A-427	0.430	10.9	0.270	6.88	0.010 ± 0.003	0.25 ± 0.08
HS2TFL01	1	23053/12A-428	0.450	11.4	0.301	7.65	0.010 ± 0.003	0.25 ± 0.08
HS2TFL00	0	23053/12A-430	0.470	11.9	0.347	8.81	0.012 ± 0.003	0.31 ± 0.08

*Dielectric Strength: $\geq 1,400$ V/M, per ASTM D 149 short term test of 10 MIL thickness (Volts/MIL)

Certifications/Compliance

- AMS-DTL-23053/12A, Class 4
- ASTM D2902 Type I
- FDA Compliant
- USP Class VI Compliant



WARNING

This product can expose you to chemicals including Tetrafluoroethylene, which is known to the State of California to cause cancer. For more information go to www.P65Warnings.ca.gov.

PTFE Heat Shrinkable Tubing

Series 4:1 HS4TFI

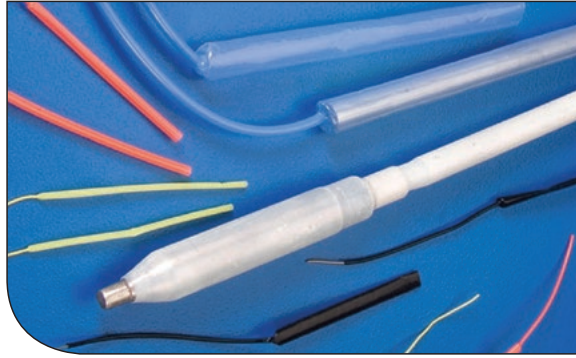

Features

- Virgin Polytetrafluoroethylene resin
- 4:1 Shrink Ratio
- Chemically inert
- Lowest coefficient of friction
- Superior dielectric strength
- Exceptional heat resistance
- Self extinguishing
- Non-wetting

Applications/Markets



- Electrical Insulation
- Protective Cover
- Rollers
- Bulb Protection

Certifications/Compliance

- AMS-DTL-23053/12A, Class 5
- ASTM D2902 Type I
- AMS 3584A
- VW1 and UL-83 (natural)
- FDA Compliant
- USP Class VI Compliant

Order Information

Example: HS4TFI5/8-NT

HS4TFI5/8-NT – Heat Shrink

HS4TFI5/8-NT – Shrink Ratio (4:1)

HS4TFI5/8-NT – PTFE

HS4TFI5/8-NT – Wall Type (Industrial Wall)

HS4TFI5/8-NT – Heat Shrink Size in inches (5/8")

HS4TFI5/8-NT – Natural

HS4TFI5/8-NT – Bulk Tubing

Colors

- ○ Natural, Opaque to translucent
- Colors available as custom run, see color code table

When ordering coiled tubing in colors, the color code is always followed by TC; when ordering cut lengths, the color code is followed by CC

i.e., HS4TFI5/8-2TC i.e., HS4TFI5/8-0CC48.0000

Color Code					
○	N	Natural	●	5	Green
●	0	Black	●	6	Blue
●	1	Brown	●	7	Violet
●	2	Red	●	8	Gray
●	3	Orange	○	9	White
●	4	Yellow			

Notes

- Working Temperature: -500°F (260°C) Shrink Temperature: 662°F (350°C) for 10 minutes AMS-DTL-23053/12A
- For full recovery, expanded diameter should be 50% larger than the diameter of the object to be recovered over
- *Dielectric Strength: $\geq 1,400$ V/M, per ASTM D 149 short term test of 10 MIL thickness (Volts/MIL)
- PTFE Fractional Heat Shrink tubing is available in stock packaging of 4-ft. straight lengths
- Custom packaging, sizes, lengths and colors are quoted upon request



WARNING

This product can expose you to chemicals including Tetrafluoroethylene, which is known to the State of California to cause cancer. For more information go to www.P65Warnings.ca.gov.

HS4TFI PTFE Industrial Wall Heat Shrink Tubing (4:1)

Part Number	Order Size inch	Mil Spec**	Minimum Expanded I.D.		Maximum Recovered I.D.		Nominal Recovered Wall	
			inch	mm	inch	mm	inch	mm
HS4TFI5/64	5/64	23053/12A-501	0.078	1.98	0.025	0.64	0.009 ± 0.002	0.23 ± 0.05
HS4TFI1/8	1/8	23053/12A-502	0.125	3.18	0.037	0.94	0.012 ± 0.002	0.31 ± 0.05
HS4TFI3/16	3/16	23053/12A-503	0.187	4.75	0.050	1.27	0.012 ± 0.002	0.31 ± 0.05
HS4TFI1/4	1/4	23053/12A-504	0.250	6.35	0.063	1.60	0.012 ± 0.002	0.31 ± 0.05
HS4TFI5/16	5/16	23053/12A-505	0.312	7.92	0.078	1.98	0.012 ± 0.002	0.31 ± 0.05
HS4TFI3/8	3/8	23053/12A-506	0.375	9.52	0.096	2.44	0.012 ± 0.002	0.31 ± 0.05
HS4TFI7/16	7/16	23053/12A-507	0.438	11.1	0.112	2.84	0.012 ± 0.002	0.31 ± 0.05
HS4TFI1/2	1/2	23053/12A-508	0.500	12.7	0.144	3.66	0.015 ± 0.004	0.38 ± 0.10
HS4TFI5/8	5/8	23053/12A-510	0.625	15.9	0.178	4.52	0.015 ± 0.004	0.38 ± 0.10
HS4TFI3/4	3/4	23053/12A-512	0.750	19.1	0.224	5.70	0.015 ± 0.004	0.38 ± 0.10
HS4TFI7/8	7/8	23053/12A-513	0.875	22.2	0.244	6.20	0.015 ± 0.004	0.38 ± 0.10
HS4TFI1.00	1	23053/12A-514	1.000	25.4	0.278	7.06	0.015 ± 0.004	0.38 ± 0.10
HS4TFI1.25	1-1/4	23053/12A-515	1.250	31.8	0.347	8.81	0.015 ± 0.004	0.38 ± 0.10

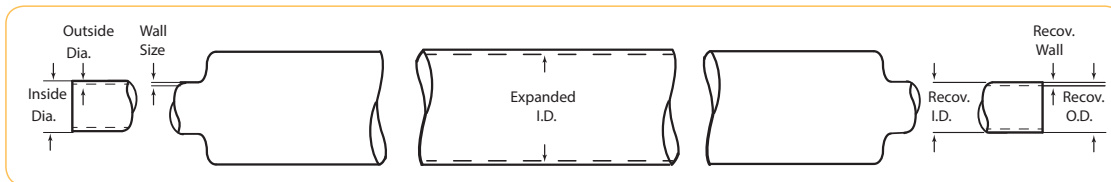

WARNING

This product can expose you to chemicals including Tetrafluoroethylene, which is known to the State of California to cause cancer. For more information go to www.P65Warnings.ca.gov.

PTFE Convoluted

Series Convo-Tex®

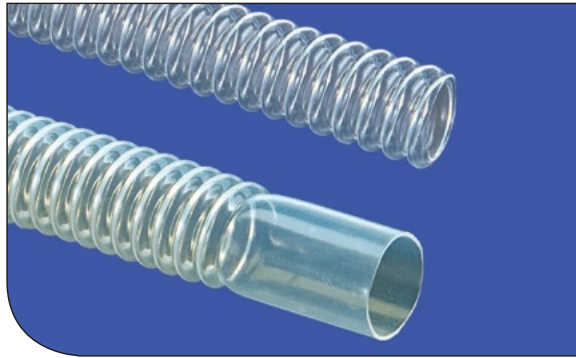

Features

- Chemically inert
- Low coefficient of friction
- Very flexible
- Self extinguishing
- Non-wetting

Certifications/Compliance

- AMS 3653E
- VW1 and UL-83 (natural)
- FDA Compliant
- USP Class VI Compliant

Applications/Markets



- Fluid Transport
- Wire Harness
- Protection/Cable Core
- Robotics

Order Information

Example: CV01-1/8-NT

CV01-1/8-NT – Convoluted

CV01-1/8-NT – PTFE

CV01-1/8-NT – Size to Order (1/8")

CV01-1/8-NT – Color (N=Natural)

CV01-1/8-NT – “T” is bulk (for cuffed tubing, remove “T” and add length, ie. CV01-1/8-N1200 = 1" Convo, natural, cut 12" long)

Colors

- ○ Natural, Opaque to Translucent
- Colors available as custom run, see color code table

Color Code					
○	N	Natural	●	5	Green
●	0	Black	●	6	Blue
●	1	Brown	●	7	Violet
●	2	Red	●	8	Gray
●	3	Orange	○	9	White
●	4	Yellow			

Notes

- Working Temperature: -100°F (-75°C) to +500°F (260°C)
- Standard cuffs for Convo-Tex are sized on the Inside Diameter
- Wire wrap reinforcement can be added for increased pressure applications or when a tighter bend radius is needed
- Custom packaging, sizes, lengths and colors are quoted upon request



WARNING

This product can expose you to chemicals including Tetrafluoroethylene, which is known to the State of California to cause cancer. For more information go to www.P65Warnings.ca.gov.

PTFE Convo-Tex® Convoluted

(Standard tubing is natural)

Part Number	Size To Order	Standard Cuff I.D. "A"		Standard Cuff Length "B"		Wall Thickness "C"		Min. Inside Diameter "D"		Max. Inside Diameter "D"		Max. Outside Diameter "E"		**Min. Bend Radius	
		inch	mm	inch	mm	inch	mm	inch	mm	inch	mm	inch	mm	inch	mm
CV01-1/8-NT	CONV-2	1/8	3.18	3/4	19.1	0.010	0.25	0.130	3.3	0.140	3.6	0.235	5.9	3/8	9.5
CV01-1/4-NT	CONV-4	1/4	6.35	3/4	19.1	0.015	0.38	0.181	4.6	0.188	4.8	0.320	8.1	1/2	12.7
CV01-5/16-NT	CONV-5	5/16	7.94	1	25.4	0.020	0.51	0.273	6.9	0.281	7.1	0.414	10.5	3/4	19.1
CV01-3/8-NT	CONV-6	3/8	9.53	1	25.4	0.020	0.51	0.303	7.7	0.312	7.9	0.450	11.4	1-3/4	44.4
CV01-1/2-NT	CONV-8	1/2	12.7	1	25.4	0.020	0.51	0.425	10.8	0.437	11.1	0.590	15.0	1-1/4	31.2
CV01-5/8-NT	CONV-10	5/8	15.9	1-1/4	31.8	0.025	0.64	0.485	12.3	0.500	12.7	0.660	16.8	1-1/2	38.1
CV01-3/4-NT	CONV-12	3/4	19.1	1-1/2	38.1	0.023	0.58	0.608	15.4	0.625	15.9	0.780	19.8	1-3/4	44.4
CV01-1.00-NT	CONV-16	1	25.4	2	50.8	0.030	0.76	0.849	21.6	0.875	22.2	1.100	27.9	2-1/4	57.2
CV01-1.25-NT	CONV-20	1-1/4	31.8	2-1/2	63.5	0.035	0.89	1.150	29.2	1.190	30.2	1.560	39.6	2-3/4	69.9
CV01-1.50-NT	CONV-24	1-1/2	38.1	2-1/2	63.5	0.040	1.02	1.410	35.8	1.490	37.8	1.910	48.5	3	76.2
CV01-2.00-NT	CONV-32	2	50.8	2-1/2	63.5	0.043	1.09	1.955	49.7	1.985	50.4	2.450	62.2	4-1/4	107.9
CV01-2.50-NT	CONV-40	2-1/2	63.5	2-1/2	63.5	0.062	1.57	2.460	62.5	2.540	64.5	3.210	81.6	5	127
CV01-3.00-NT	CONV-48	3	76.2	2-1/2	63.5	0.070	1.78	2.940	74.7	3.060	77.7	3.750	95.3	7	177.8
CV01-4.00-NT	CONV-64	4	101.6	2-1/2	63.5	0.070	1.78	3.940	100.1	4.060	103.1	4.750	120.6	9	228.6

** Minimum 36" length.

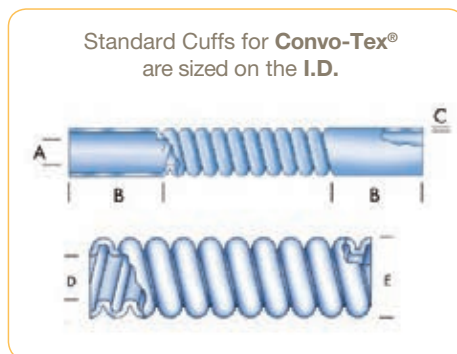
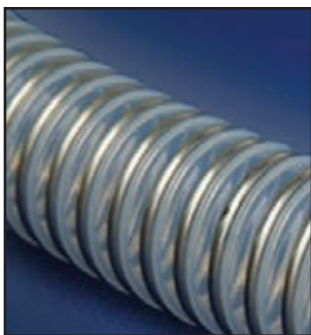
**WARNING**

This product can expose you to chemicals including Tetrafluoroethylene, which is known to the State of California to cause cancer. For more information go to www.P65Warnings.ca.gov.

PTFE Convoluted

Series Low Profile and Heavy Wall

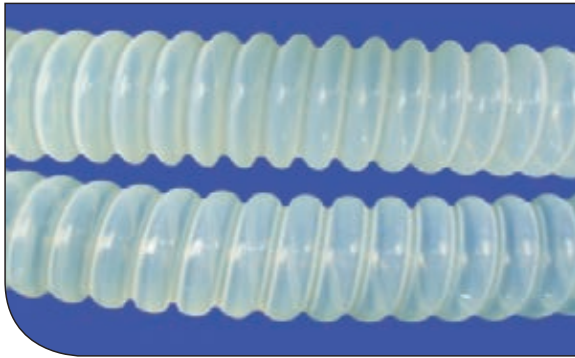

Features

- Chemically inert
- Low coefficient of friction
- Very flexible
- Self extinguishing
- Non-wetting

Low Profile

- Larger inside diameter
- Increased Flow

Heavy Wall

- Reinforces the strength of the tube allowing for braiding or covering, flanging or flaring
- Handles higher vacuum

Applications/Markets



- Fluid Handling
- Harnesses
- Lab Equipment
- Robotics

Certifications/Compliance

- AMS 3653E
- VW1 and UL-83
- FDA Compliant
- USP Class VI Compliant

Order Information

Example: CVH01-1/8-NT

CVH01-1/8-NT – CVH - Heavywall Convoluted
– CVL Low Profile Convoluted

CVH01-1/8-NT – **PTFE**

CVH01-1/8-NT – **Size to Order (1/8")**

CVH01-1/8-NT – **Color (N=Natural)**

CVH01-1/8-NT- **"T" is bulk** (for cuffed tubing, remove "T" and add length, ie. CVH01-1/8-N1200 = 1" Heavy Wall Convo, natural, cut 12" long)

Colors

- ○ Natural, Opaque to Translucent
- Colors available as custom run, see color code table

Color Code					
○	N	Natural	●	5	Green
●	0	Black	●	6	Blue
●	1	Brown	●	7	Violet
●	2	Red	●	8	Gray
●	3	Orange	○	9	White
●	4	Yellow			

Notes

- Working Temperature: 500°F (260°C)
- Standard cuffs for Convo-Tex are sized on the Inside Diameter
- Wire wrap reinforcement can be added for increased pressure applications or when a tighter bend radius is needed
- Custom packaging, sizes, lengths, cuffs and colors are quoted upon request



WARNING

This product can expose you to chemicals including Tetrafluoroethylene, which is known to the State of California to cause cancer. For more information go to www.P65Warnings.ca.gov.

PTFE Low Profile Convolved

(Standard tubing is natural)

Part Number	Size To Order	Min. Inside Diameter		Max. Inside Diameter		Max. Outside Diameter		Wall Thickness		**Min. Bend Radius	
		inch	mm	inch	mm	inch	mm	inch	mm	inch	mm
CVL01-3/8-NT	3/8	0.394	10.0	0.406	10.3	0.560	14.2	0.023	0.58	1/2	13
CVL01-1/2-NT	1/2	0.490	12.5	0.510	13.0	0.700	17.8	0.025	0.64	3/4	19
CVL01-3/4-NT	3/4	0.740	18.8	0.760	19.3	0.980	24.9	0.035	0.89	1.88	48
CVL01-1.00-NT	1	0.990	25.1	1.010	25.7	1.260	32.0	0.035	0.89	2-1/4	57
CVL01-1.25-NT	1-1/4	1.210	30.7	1.250	31.8	1.539	39.1	0.035	0.89	3	76
CVL01-1.50-NT	1-1/2	1.520	38.6	1.540	39.1	1.870	47.5	0.044	1.12	3-1/2	89
CVL01-1.75-NT	1-3/4	1.690	42.9	1.750	44.5	2.100	53.3	0.040	1.02	4-1/4	108
CVL01-2.00-NT	2	2.010	51.1	2.030	51.6	2.370	60.2	0.043	1.09	4-3/4	121

** Minimum 36 length.

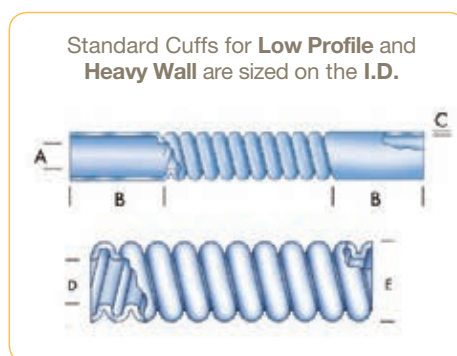
**PTFE Heavy Wall Convolved**

(Standard tubing is natural)

Part Number	Size To Order	Min. Inside Diameter		Max. Inside Diameter		Max. Outside Diameter		Wall Thickness		**Min. Bend Radius	
		inch	mm	inch	mm	inch	mm	inch	mm	inch	mm
CVH01-1/4-NT	1/4	0.257	6.5	0.265	6.7	0.415	10.5	0.025	0.38	3/4	19
CVH01-3/8-NT	3/8	0.335	8.5	0.345	8.8	0.510	13.0	0.025	0.64	1	25
CVH01-1/2-NT	1/2	0.454	11.5	0.466	11.8	0.700	17.8	0.035	0.89	1-1/2	38
CVH01-3/4-NT	3/4	0.683	17.4	0.701	17.8	1.010	25.7	0.050	1.27	1.88	48
CVH01-1.00-NT	1	0.841	21.4	0.859	21.8	1.210	30.7	0.053	1.35	2-1/2	64
CVH01-1.25-NT	1-1/4	1.125	28.6	1.145	29.1	1.610	40.9	0.062	1.57	3.13	79
CVH01-1.50-NT	1-1/2	1.420	36.1	1.480	37.6	1.880	47.8	0.062	1.57	3-3/4	95
CVH01-1.75-NT	1-3/4	1.540	39.1	1.600	40.6	2.100	53.3	0.062	1.57	4-1/2	114
CVH01-2.00-NT	2	1.770	45.0	1.830	46.5	2.432	61.8	0.062	1.57	4-3/4	120
CVH01-2.50-NT	2-1/2	2.460	62.5	2.540	64.5	3.210	81.5	0.062	1.57	5	127
CVH01-3.00-NT	3	2.940	74.7	3.060	77.7	3.750	95.3	0.062	1.57	7	178
CVH01-4.00-NT	4	3.90	100	4.060	103	4.750	121	0.070	1.77	9	229

** Minimum 36 length.

**WARNING**

This product can expose you to chemicals including Tetrafluoroethylene, which is known to the State of California to cause cancer. For more information go to www.P65Warnings.ca.gov.

PTFE Convoluted

Series AMS-T-81914/1 and AMS-T-81914/2



Features

- Chemically inert
- Low coefficient of friction
- Very flexible
- Self extinguishing
- Non-wetting

Certifications/Compliance

- AMS 3653E
- AMS-T-81914/1
- AMS-T-81914/2
- FDA Compliant

Applications/Markets



- Fluid Handling
- Harnesses
- Crush Resistant Cover
- Robotics

Order Information

Example: 81914/1-1010-0TC

81914/1-1010-0TC – AMS-T-81914 Convoluted

81914/1-1010-0TC – **PTFE**

81914/1-1010-0TC – **Helical Convolutions**

81914/1-1010-0TC – **Size (10=1.000")**

81914/1-1010-0TC – **Color (0=Black)**

81914/1-1010-0**TC** – **"T" is bulk** - (for cuffed tubing, remove "T" and add length, ie. 81914/1-1010-01200 = 187" Convo, black, cut 12" long

Colors

- ● Black
- Colors available as custom run, see color code table

When ordering convoluted tubing in colors, the "N" designation for natural should be replaced by the correct color designator;

i.e.,81914/1-101-0T (black bulk tubing)

i.e.,81914/1-101-01200 (black tubing - 12 inches long)

Color Code					
○	N	Natural	●	5	Green
●	0	Black	●	6	Blue
●	1	Brown	●	7	Violet
●	2	Red	●	8	Gray
●	3	Orange	○	9	White
●	4	Yellow			

Notes

- Working Temperature: 500°F (260°C)
- Tubing is provided in black without cuffs direct from inventory
- Stock packaging is random coils
- Also available in close convolution 81914/2
- Custom packaging, sizes, lengths, cuffs and colors are quoted upon request



WARNING

This product can expose you to chemicals including Tetrafluoroethylene, which is known to the State of California to cause cancer. For more information go to www.P65Warnings.ca.gov.

PTFE Convuluted Tubing (AMS-T-81914/1)

(Standard tubing is black)

Part Number	MIL Spec*	Maximum Inside Diameter		Minimum Inside Diameter		Maximum Outside Diameter		Maximum Wall Thickness		Minimum Bend Radius		Pitch ±1	Weight	
		inch	mm	inch	mm	inch	mm	inch	mm	inch	mm		lb./100 ft.	kg./100 mtr.
81914/1-1001-OTC	-1	0.188	4.78	0.181	4.6	0.320	8.13	0.023	0.584	1/2	13	8	2	2.98
81914/1-1002-OTC	-2	0.281	7.14	0.273	6.93	0.414	10.5	0.027	0.686	3/4	19	7.5	2.9	4.32
81914/1-1003-OTC	-3	0.312	7.93	0.303	7.7	0.450	11.4	0.027	0.686	7/8	22	7.5	3.6	5.36
81914/1-1004-OTC	-4	0.375	9.53	0.364	9.25	0.530	13.5	0.029	0.737	1	25	7	4.2	6.25
81914/1-1005-OTC	-5	0.437	11.1	0.425	10.8	0.590	15.0	0.029	0.737	1-1/4	32	7	4.9	7.29
81914/1-1006-OTC	-6	0.500	12.7	0.485	12.3	0.660	16.8	0.029	0.737	1-1/2	38	7	5.2	7.74
81914/1-1007-OTC	-7	0.625	15.9	0.608	15.4	0.780	19.9	0.035	0.889	1-3/4	44	7	6.9	10.3
81914/1-1008-OTC	-8	0.750	19.1	0.730	18.5	0.975	24.8	0.035	0.889	1.88	48	6	10.4	15.5
81914/1-1009-OTC	-9	0.875	22.2	0.850	21.6	1.100	27.9	0.035	0.889	2-1/4	57	6	11.3	16.8
81914/1-1010-OTC	-10	1.000	25.4	0.975	24.8	1.260	32.0	0.035	0.889	2-1/2	64	4.5	12.6	18.8
81914/1-1011-OTC	-11	1.125	28.6	1.100	27.9	1.390	35.3	0.035	0.889	2-3/4	70	4.5	13.8	20.5
81914/1-1012-OTC	-12	1.250	31.8	1.210	30.7	1.539	39.1	0.035	0.889	3	76	4	15.5	23.1
81914/1-1013-OTC	-13	1.500	38.1	1.440	36.6	1.850	47.0	0.040	1.020	3.75	95	4	21.7	32.3
81914/1-1014-OTC	-14	1.750	44.5	1.690	42.9	2.100	53.3	0.045	1.140	4.25	108	4	25.3	37.6
81914/1-1015-OTC	-15	2.000	50.8	1.940	49.3	2.350	59.7	0.045	1.140	4.75	121	4	29	43.2

*PTFE convuluted tubing is provided in BLACK without cuffs direct from the factory. Black part numbers are designated with "OT" and Natural part numbers are designated with "NT" after the Mil Spec number (i.e.,81914/1-1014-OT).

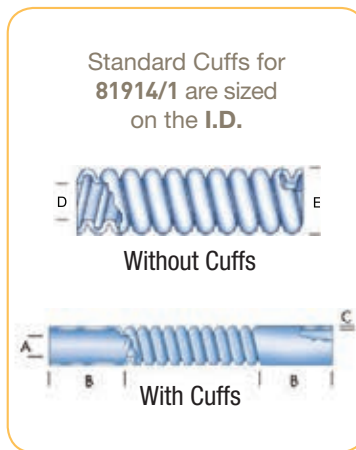

WARNING This product can expose you to chemicals including Tetrafluoroethylene, which is known to the State of California to cause cancer. For more information go to www.P65Warnings.ca.gov.

FEP Tubing

Series Fractional & Metric: 103, 203

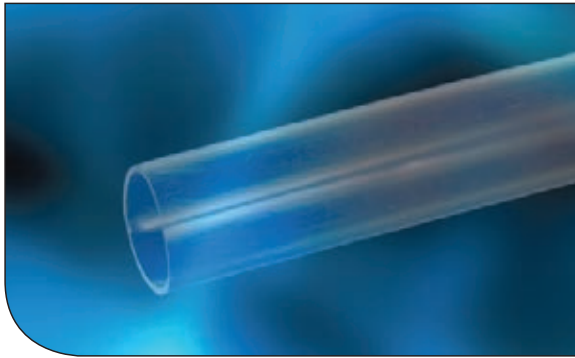

Features

- Virgin Fluorinated Ethylene Propylene resin
- Translucent
- Chemically inert
- Long continuous lengths
- Low coefficient of friction
- Self extinguishing
- Non-wetting
- Weldable

Certifications/Compliance

- ASTM D2116-07
- FDA Compliant
- VW1 and UL-83 (natural)
- USP Class VI Compliant

Applications/Markets



- Nitrogen Transfer
- Down Hole Pump
- Ozone Sampling
- Food & Beverage
- Optical Sensor
- Catheter Repair
- Laboratory
- Syringe Tips

Order Information

Example: 103-0250031-NT-100

103-0250031-NT-100 – Fractional

103-0250031-NT-100 – FEP

103-0250031-NT-100 – Tube O.D. in inches (1/4")

103-0250031-NT-100 – Tube Wall Thickness in inches (.031")

103-0250031-NT-100 – Natural

103-0250031-NT-100 – Package Quantity in feet (100')

FEP Tubing (Series 103, 203) Maximum Working Pressure (bar)

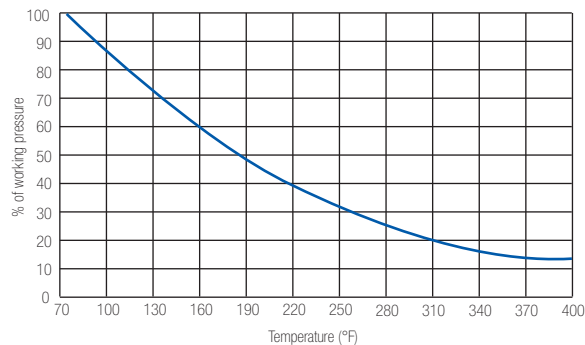

Fittings

Fittings available for sizes 1/8" up to 1"

Parker Fittings available from:

Fluid System Connectors Division

Otsego, MI (269) 692-6555 (269) 692-6634 FAX

FSC Product Families:

- Compression
- Compress-Align®
- Metric Compression
- Flow-Controls
- Prestolok Composite
- Prestolok All-Metal
- Prestolok Stainless
- TrueSeal™

Notes

- Working Temperature: -100°F (-75°C) to +400°F (204°C)
- Working pressure calculated using a Design Factor of 4 at 73°F (23°C)
- Custom packaging and sizes are quoted upon request

Options

- Smoothbore
- Retractable Coils
- Convoluted
- Paratubing
- Corrugated

Colors

- ○ Natural, Translucent
- Colors available as custom run, see color code table

Color Code					
○	N	Natural	●	5	Green
●	0	Black	●	6	Blue
●	1	Brown	●	7	Violet
●	2	Red	●	8	Gray
●	3	Orange	○	9	White
●	4	Yellow			



WARNING

This product can expose you to chemicals including Tetrafluoroethylene, which is known to the State of California to cause cancer. For more information go to www.P65Warnings.ca.gov.

103 FEP Industrial Wall Fractional Size Tubing

Part Number	Order Size	Nominal O.D.				Nominal I.D.				Reference Wall		Working Pressure		Burst Pressure		Min. Bend Radius		Vac. Rating	Weight	
		inch	inch	tol.	mm	tol.	inch	tol.	mm	tol.	inch	mm	psi 73°F	bar 23°C	psi 73°F	bar 23°C	inch		mm	at 73°F
#																				
103-0094031	3/32	0.094	±0.005	2.40	±0.127	0.031	±0.002	0.79	±0.051	0.031	0.79	630	43	2520	174	0.500	13	28	0.006	0.009
103-0125031	1/8	0.125	±0.003	3.18	±0.076	0.062	±0.003	1.57	±0.076	0.031	0.79	470	32	1880	130	0.375	10	28	0.009	0.013
103-0156031	5/32	0.157	±0.005	3.99	±0.127	0.094	±0.005	2.39	±0.127	0.031	0.79	360	25	1440	99	0.375	10	28	0.011	0.017
103-0188031	3/16	0.188	±0.005	4.78	±0.127	0.125	±0.005	3.18	±0.127	0.031	0.79	290	20	1160	80	0.750	19	28	0.014	0.021
103-0250031	1/4	0.250	±0.005	6.35	±0.127	0.188	±0.005	4.78	±0.127	0.031	0.79	210	14	840	58	1.750	44	28	0.020	0.030
103-0312031	5/16	0.312	±0.005	7.92	±0.127	0.250	±0.005	6.35	±0.127	0.031	0.79	160	11	640	44	2.250	57	28	0.025	0.038
103-0375031	3/8	0.375	±0.005	9.52	±0.127	0.312	±0.005	7.92	±0.127	0.031	0.79	130	9	520	36	2.750	70	28	0.031	0.047
103-0438031	7/16	0.438	±0.005	11.13	±0.127	0.375	±0.005	9.52	±0.127	0.031	0.79	110	8	440	30	4.000	102	28	0.037	0.055
103-0500031	1/2	0.500	±0.006	12.70	±0.152	0.438	±0.006	11.13	±0.152	0.031	0.79	90	6	360	25	4.000	102	28	0.043	0.063
103-0563031	9/16	0.563	±0.006	14.30	±0.152	0.500	±0.006	12.70	±0.152	0.031	0.79	80	6	320	22	5.000	127	28	0.054	0.080

103 FEP Heavy Wall Fractional Size Tubing

Part Number	Order Size	Nominal O.D.				Nominal I.D.				Reference Wall		Working Pressure		Burst Pressure		Min. Bend Radius		Vac. Rating	Weight	
		inch	inch	tol.	mm	tol.	inch	tol.	mm	tol.	inch	mm	psi 73°F	bar 23°C	psi 73°F	bar 23°C	inch		mm	at 73°F
#																				
103-0188062	3/16	0.188	±0.005	4.78	±0.127	0.064	±0.005	1.63	±0.127	0.062	1.57	630	43	2520	174	0.250	6	28	0.023	0.034
103-0250040	1/4	0.250	±0.005	6.35	±0.127	0.170	±0.005	4.32	±0.127	0.040	1.02	280	19	1120	77	1.250	32	28	0.025	0.037
103-0250047	1/4	0.250	±0.005	6.35	±0.127	0.156	±0.005	3.96	±0.127	0.047	1.19	340	23	1360	94	0.750	19	28	0.028	0.042
103-0250062	1/4	0.250	±0.005	6.35	±0.127	0.125	±0.005	3.18	±0.127	0.062	1.57	470	32	1880	130	0.750	19	28	0.034	0.051
103-0312062	5/16	0.312	±0.005	7.92	±0.127	0.188	±0.005	4.78	±0.127	0.062	1.57	360	25	1440	99	1.375	35	28	0.045	0.067
103-0375062	3/8	0.375	±0.005	9.52	±0.127	0.250	±0.005	6.35	±0.127	0.062	1.57	290	20	1160	80	1.500	38	28	0.057	0.085
103-0438062	7/16	0.438	±0.005	11.13	±0.127	0.312	±0.005	7.92	±0.127	0.062	1.57	250	17	1000	69	2.625	67	28	0.068	0.101
103-0500062	1/2	0.500	±0.005	12.70	±0.127	0.375	±0.005	9.53	±0.127	0.062	1.57	210	14	840	58	2.125	54	28	0.079	0.118
103-0625062	5/8	0.625	±0.006	15.88	±0.152	0.500	±0.006	12.70	±0.152	0.062	1.57	160	11	640	44	3.000	76	28	0.102	0.152
103-0750062	3/4	0.750	±0.006	19.05	±0.152	0.625	±0.006	15.88	±0.152	0.062	1.57	130	9	520	36	6.000	152	28	0.125	0.186
103-1000062	1	1.000	±0.010	25.40	±0.254	0.875	±0.010	22.22	±0.254	0.062	1.57	90	6	360	25	8.000	203	28	0.170	0.253

203 Metric FEP Tubing

Part Number	Order Size	Nominal O.D.				Nominal I.D.				Reference Wall		Working Pressure		Burst Pressure		Min. Bend Radius		Vac. Rating	Weight	
		mm	mm	tol.	inch	tol.	mm	tol.	inch	tol.	mm	inch	bar 23°C	psi 73°F	bar 23°C	psi 73°F	mm		inch	at 73°F
#																				
203-0300100	3	3	±0.11	0.118	±0.004	1	±0.11	0.039	±0.004	1	0.039	27	390	108	1560	6	0.250	28	0.014	0.009
203-0400100	4	4	±0.11	0.157	±0.004	2	±0.11	0.079	±0.004	1	0.039	20	290	80	1160	13	0.500	28	0.020	0.014
203-0500100	5	5	±0.11	0.197	±0.004	3	±0.11	0.118	±0.004	1	0.039	15	220	61	880	19	0.750	28	0.027	0.018
203-0600100	6	6	±0.13	0.236	±0.005	4	±0.13	0.157	±0.005	1	0.039	12	180	50	720	29	1.125	28	0.034	0.023
203-0700100	7	7	±0.13	0.276	±0.005	5	±0.13	0.197	±0.005	1	0.039	10	150	41	600	44	1.750	28	0.041	0.027
203-0800100	8	8	±0.13	0.315	±0.005	6	±0.13	0.236	±0.005	1	0.039	9	130	36	520	51	2.000	28	0.047	0.032
203-0900100	9	9	±0.13	0.354	±0.005	7	±0.13	0.275	±0.005	1	0.039	8	110	30	440	54	2.125	28	0.054	0.036
203-1000100	10	10	±0.13	0.393	±0.005	8	±0.13	0.315	±0.005	1	0.039	7	100	28	400	70	2.750	28	0.061	0.041
203-1200100	12	12	±0.15	0.472	±0.006	10	±0.15	0.394	±0.006	1	0.039	6	80	22	320	76	3.000	28	0.074	0.050

WARNING This product can expose you to chemicals including Tetrafluoroethylene, which is known to the State of California to cause cancer. For more information go to www.P65Warnings.ca.gov.

FEP Heat Shrinkable Tubing

Series 1.3:1 HS1.3FEP

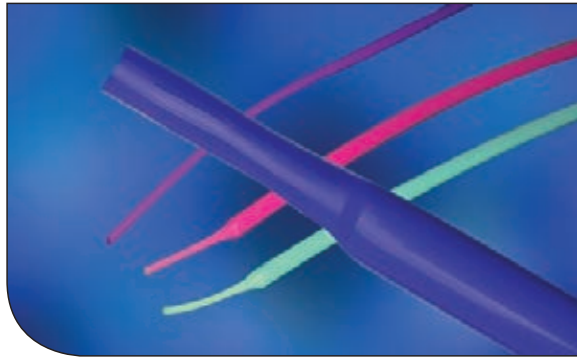

Features

- Easier to shrink than PTFE
- Chemically inert
- Low coefficient of friction
- Superior dielectric strength
- Good heat resistance
- Self extinguishing
- Non-wetting

Certifications/Compliance

- AMS-DTL-23053/11A, Class 1
- ASTM D2902 Type II
- ASTM D3296-03
- VWI and UL-83 (natural)
- FDA Compliant
- USP Class VI Compliant

Applications/Markets



- Protective Cover
- UV Light Covering
- Product Testing
- Rollers

Order Information

Example: HS1.3FEP24-0CC48.000

HS1.3FEP24-0CC48.000 – Heat Shrink

HS1.3FEP24-0CC48.000 – Shrink Ratio (1.3:1)

HS1.3FEP24-0CC48.000 – FEP

HS1.3FEP24-0CC48.000 – Heat Shrink Size in AWG

(AWG 24) (For inch size use inch (3/8"))

HS1.3FEP24-0CC48.000 – Black

HS1.3FEP24-0CC48.000 – Package Quantity in feet (48")

Colors

- ○ Natural, Translucent
- Colors available as custom run, see color code table

When ordering coiled tubing in colors, the color code is always followed by TC; when ordering cut lengths, the color code is followed by CC
i.e., HS1.3FEP24-2TC
i.e., HS1.3FEP24-0CC48.000

Color Code					
○	N	Natural	●	5	Green
●	0	Black	●	6	Blue
●	1	Brown	●	7	Violet
●	2	Red	●	8	Gray
●	3	Orange	○	9	White
●	4	Yellow			

Notes

- Working Temperature: -100°F (-75°C) to +400°F (204°C)
- Shrink Temperature: 1" Dia. and below : 410°F (210°C) Over 1" Dia. : 430°F (221°C)
- *Dielectric Strength: $\geq 2,000$ V/M, per ASTM D 149 short term test of 10 MIL thickness (Volts/MIL)
- Heat Shrink tubing is available in stock packaging of 4-ft. straight lengths
- Custom packaging, sizes, lengths and colors are quoted upon request



WARNING

This product can expose you to chemicals including Tetrafluoroethylene, which is known to the State of California to cause cancer. For more information go to www.P65Warnings.ca.gov.

HS1.3FEP AWG Heat Shrink Tubing (1.3:1)

Part Number	Order Size AWG	Mil Spec*	Minimum Expanded I.D.		Maximum Recovered I.D.		Nominal Recovered Wall	
			inch	mm	inch	mm	inch	mm
HS1.3FEP24	24	23053/11A-101	0.031	0.79	0.027	0.69	0.008 ± 0.002	0.20 ± 0.05
HS1.3FEP22	22	23053/11A-102	0.036	0.91	0.032	0.81	0.008 ± 0.002	0.20 ± 0.05
HS1.3FEP20	20	23053/11A-103	0.045	1.14	0.039	0.99	0.008 ± 0.002	0.20 ± 0.05
HS1.3FEP18	18	23053/11A-104	0.060	1.52	0.049	1.25	0.008 ± 0.002	0.20 ± 0.05
HS1.3FEP16	16	23053/11A-105	0.075	1.90	0.061	1.55	0.009 ± 0.002	0.23 ± 0.05
HS1.3FEP14	14	23053/11A-106	0.092	2.34	0.072	1.83	0.009 ± 0.002	0.23 ± 0.05
HS1.3FEP12	12	23053/11A-107	0.115	2.92	0.089	2.26	0.009 ± 0.002	0.23 ± 0.05
HS1.3FEP10	10	23053/11A-108	0.141	3.58	0.114	2.90	0.010 ± 0.003	0.25 ± 0.08
HS1.3FEP09	9	23053/11A-109	0.158	4.01	0.124	3.15	0.010 ± 0.003	0.25 ± 0.08
HS1.3FEP08	8	23053/11A-110	0.180	4.57	0.143	3.63	0.010 ± 0.003	0.25 ± 0.08
HS1.3FEP07	7	23053/11A-111	0.197	5.00	0.158	4.01	0.011 ± 0.004	0.28 ± 0.10
HS1.3FEP06	6	23053/11A-112	0.225	5.72	0.180	4.57	0.011 ± 0.004	0.28 ± 0.10
HS1.3FEP05	5	23053/11A-113	0.248	6.30	0.198	5.03	0.011 ± 0.004	0.28 ± 0.10
HS1.3FEP04	4	23053/11A-114	0.290	7.37	0.226	5.74	0.011 ± 0.004	0.28 ± 0.10
HS1.3FEP03	3	23053/11A-115	0.310	7.87	0.249	6.32	0.011 ± 0.003	0.28 ± 0.08
HS1.3FEP02	2	23053/11A-116	0.365	9.27	0.280	7.11	0.012 ± 0.004	0.31 ± 0.10
HS1.3FEP01	1	23053/11A-117	0.400	10.2	0.311	7.90	0.012 ± 0.004	0.31 ± 0.10
HS1.3FEP00	0	23053/11A-118	0.440	11.2	0.349	8.86	0.012 ± 0.004	0.31 ± 0.10

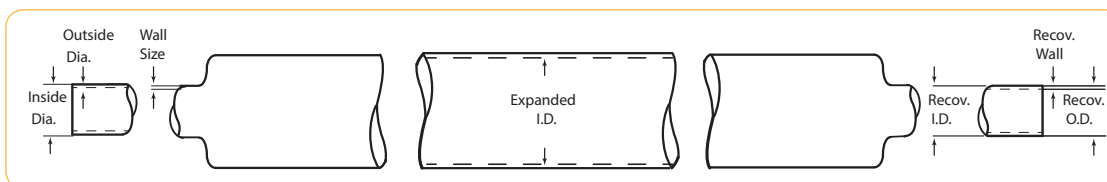

HS1.3FEP Fractional Heat Shrink Tubing (1.3:1)

Part Number	Order Size inch	Mil Spec*	Minimum Expanded I.D.		Maximum Recovered I.D.		Nominal Recovered Wall	
			inch	mm	inch	mm	inch	mm
HS1.3FEP3/8	3/8	23053/11A-119	0.500	12.7	0.383	9.73	0.015 ± 0.004	0.38 ± 0.10
HS1.3FEP7/16	7/16	23053/11A-120	0.580	14.7	0.448	11.4	0.020 ± 0.004	0.51 ± 0.10
HS1.3FEP1/2	1/2	23053/11A-121	0.666	16.9	0.510	13.0	0.020 ± 0.004	0.51 ± 0.10
HS1.3FEP5/8	5/8	23053/11A-122	0.830	21.1	0.637	16.2	0.025 ± 0.004	0.64 ± 0.10
HS1.3FEP3/4	3/4	23053/11A-123	1.000	25.4	0.764	19.4	0.030 ± 0.004	0.76 ± 0.10
HS1.3FEP7/8	7/8	23053/11A-124	1.170	29.7	0.891	22.6	0.035 ± 0.004	0.89 ± 0.10
HS1.3FEP1.00	1	23053/11A-126	1.330	33.8	1.020	25.9	0.035 ± 0.004	0.89 ± 0.10
HS1.3FEP1.13	1-1/8	23053/11A-133	1.500	38.1	1.145	29.1	0.035 ± 0.004	0.89 ± 0.10
HS1.3FEP1.25	1-1/4	23053/11A-134	1.666	42.3	1.270	32.3	0.035 ± 0.004	0.89 ± 0.10
HS1.3FEP1.38	1-3/8	23053/11A-135	1.833	46.6	1.390	35.3	0.035 ± 0.004	0.89 ± 0.10
HS1.3FEP1.50	1-1/2	23053/11A-136	2.000	50.8	1.520	38.6	0.035 ± 0.004	0.89 ± 0.10



WARNING

This product can expose you to chemicals including Tetrafluoroethylene, which is known to the State of California to cause cancer. For more information go to www.P65Warnings.ca.gov.

Tubing
Fluoropolymer

Coiled Air Hose
& Fittings

Transportation

Fittings

Tooling,
Equipment
& Accessories

General
Technical

FEP Heat Shrinkable Tubing

Series 1.67:1 HS1.6FEP

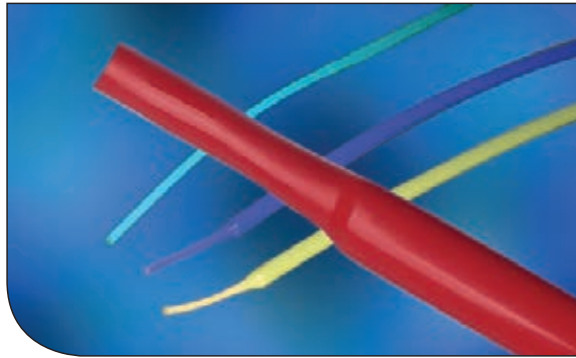

Features

- Easier to shrink than PTFE
- Chemically inert
- Low coefficient of friction
- Superior dielectric strength
- Good heat resistance
- Self extinguishing
- Non-wetting

Certifications/Compliance

- AMS-DTL-23053/11A, Class 2
- ASTM 2902 Type II
- ASTM D3296-03
- VW1 and UL-83 (natural)
- FDA Compliant
- USP Class VI Compliant

Applications/Markets



- Protective Cover
- UV Light Covering
- Product Testing
- Rollers

Order Information

Example: HS1.6FEP3/32-NC48.000

HS1.6FEP3/32-NC48.000 – Heat Shrink

HS1.6FEP3/32-NC48.000 – Shrink Ratio (1.67:1)

HS1.6FEP3/32-NC48.000 – FEP

HS1.6FEP3/32-NC48.000 – Heat Shrink Size in inches (3/32")

HS1.6FEP3/32-NC48.000 – Natural

HS1.6FEP3/32-NC48.000 – Cut Tubing

HS1.6FEP3/32-NC48.000 – Package Quantity in feet (48")

Colors

- ○ Natural, Translucent
- Colors available as custom run, see color code table

When ordering coiled tubing in colors, the color code is always followed by TC; when ordering cut lengths, the color code is followed by CC
i.e., HS1.6FEP3/32-2TC
i.e., HS1.6FEP3/32-0CC48.000

Color Code					
○	N	Natural	●	5	Green
●	0	Black	●	6	Blue
●	1	Brown	●	7	Violet
●	2	Red	●	8	Gray
●	3	Orange	○	9	White
●	4	Yellow			

Notes

- Working Temperature: -100°F (-75°C) to +400°F (204°C)
- Shrink Temperature: 1" Dia. and below: 410°F (210°C) Over 1" Dia.: 430°F (221°C)
- *Dielectric Strength: $\geq 2,000$ V/M, per ASTM D 149 short term test of 10 MIL thickness (Volts/MIL)
- Heat Shrink tubing is available in stock packaging of 4-ft. straight lengths
- Custom packaging, sizes, lengths and colors are quoted upon request



WARNING

This product can expose you to chemicals including Tetrafluoroethylene, which is known to the State of California to cause cancer. For more information go to www.P65Warnings.ca.gov.

HS1.6FEP Fractional Heat Shrink Tubing (1.67:1)

Part Number	Order Size inch	Mil Spec*	Minimum Expanded I.D.		Maximum Recovered I.D.		Nominal Recovered Wall	
			inch	mm	inch	mm	inch	mm
HS1.6FEP3/32	3/32	23053/11A-201	0.093	2.36	0.056	1.42	0.008 ± 0.003	0.20 ± 0.08
HS1.6FEP1/8	1/8	23053/11A-202	0.125	3.18	0.075	1.90	0.010 ± 0.003	0.25 ± 0.08
HS1.6FEP3/16	3/16	23053/11A-203	0.188	4.78	0.115	2.92	0.010 ± 0.003	0.25 ± 0.08
HS1.6FEP1/4	1/4	23053/11A-204	0.250	6.35	0.150	3.81	0.010 ± 0.003	0.25 ± 0.08
HS1.6FEP3/8	3/8	23053/11A-205	0.375	9.52	0.225	5.72	0.012 ± 0.003	0.31 ± 0.08
HS1.6FEP1/2	1/2	23053/11A-206	0.500	12.7	0.300	7.62	0.015 ± 0.004	0.38 ± 0.10
HS1.6FEP3/4	3/4	23053/11A-207	0.750	19.1	0.450	11.4	0.020 ± 0.004	0.51 ± 0.10
HS1.6FEP1.00	1	23053/11A-208	1.000	25.4	0.600	15.2	0.025 ± 0.005	0.64 ± 0.13
HS1.6FEP1.50	1-1/2	23053/11A-209	1.500	38.1	0.900	22.9	0.030 ± 0.005	0.76 ± 0.13
HS1.6FEP2.00	2	23053/11A-210	2.000	50.8	1.200	30.5	0.030 ± 0.005	0.76 ± 0.13

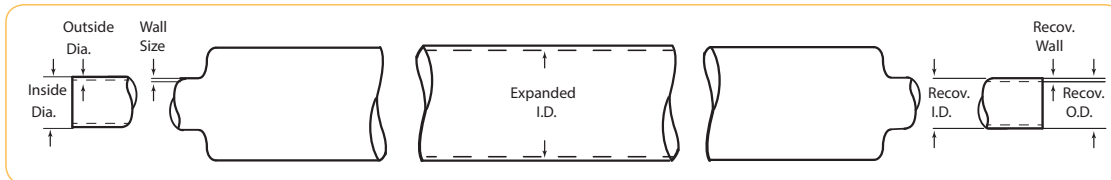

WARNING

This product can expose you to chemicals including Tetrafluoroethylene, which is known to the State of California to cause cancer. For more information go to www.P65Warnings.ca.gov.

FEP Heat Shrinkable Roll Cover

Series 1.25:1 HS1.25FEP

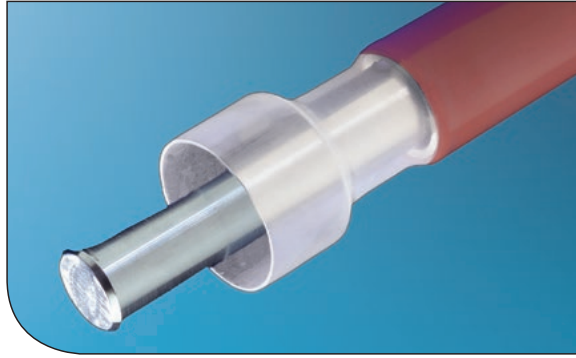

Features

- Extends roller life
- Eliminates roller build up and picking
- Low coefficient of friction
- Flexible
- Good heat resistance

Certifications/Compliance

- ASTM D2902 Type II
- VW1 and UL-83 (natural)

Applications/Markets



- Protective Cover
- Rollers

Order Information

Example: HS1.25FEP3.50-NC48.000

HS1.25FEP3.50-NC48.000 – Heat Shrink

HS1.25FEP3.50-NC48.000 – Shrink Ratio (1.25:1)

HS1.25FEP3.50-NC48.000 – FEP

HS1.25FEP3.50-NC48.000 – Heat Shrink Expanded

Size inches (3 1/2 in)

HS1.25FEP3.50-NC48.000 – Natural

HS1.25FEP3.50-NC48.000 – Cut Tubing

HS1.25FEP3.50-NC48.000 – Package Quantity in feet (48")

Colors

- ○ Natural, Translucent

Notes

- Working Temperature: -100°F (-75°C) to +400°F (204°C)
- Shrink Temperature: 347°F (175°C) for 10 minutes - For high temperatures 500°F (260°C), PFA roll covers are available
- Dielectric Strength: $\geq 2,000$ V/M, per ASTM D 149 short term test of 10 MIL thickness (Volts/MIL)
- Roll Cover is available in stock packaging of 4-ft. straight lengths
- Custom packaging, sizes, lengths and colors are quoted upon request
- For adhesion purposes, roll covers must be etched; Etching is available on the inside diameter, outside diameter or both



WARNING

This product can expose you to chemicals including Tetrafluoroethylene, which is known to the State of California to cause cancer. For more information go to www.P65Warnings.ca.gov.

HS1.25.1 FEP Roll Cover

Part Number	Order Size	Minimum Expanded I.D.		Maximum Recovered I.D.		Nominal Recovered Wall	
		inch	mm	inch	mm	inch	mm
HS1.25FEP1.00	1	1.100	27.9	0.880	22.4	0.020 ± 0.004	0.508 ± 0.10
HS1.25FEP1.25	1 1/4	1.300	33.0	1.000	25.4	0.020 ± 0.004	0.508 ± 0.10
HS1.25FEP1.50	1-1/2	1.700	43.2	1.300	33.0	0.020 ± 0.004	0.508 ± 0.10
HS1.25FEP2.00	2	2.100	53.3	1.700	43.2	0.020 ± 0.004	0.508 ± 0.10
HS1.25FEP2.25	2-1/4	2.260	59.7	2.000	50.8	0.020 ± 0.004	0.508 ± 0.10
HS1.25FEP2.50	2-1/2	2.600	66.0	2.100	53.3	0.020 ± 0.004	0.508 ± 0.10
HS1.25FEP3.00	3	3.100	78.7	2.600	66.0	0.020 ± 0.004	0.508 ± 0.10
HS1.25FEP3.50	3-1/2	3.500	88.9	3.100	78.7	0.020 ± 0.004	0.508 ± 0.10
HS1.25FEP4.00	4	4.300	109.2	3.500	88.9	0.020 ± 0.004	0.508 ± 0.10
HS1.25FEP5.00	5	5.200	132.1	4.300	109.3	0.020 ± 0.004	0.508 ± 0.10

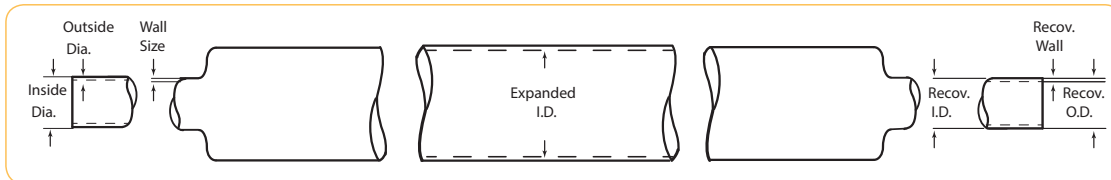

WARNING

This product can expose you to chemicals including Tetrafluoroethylene, which is known to the State of California to cause cancer. For more information go to www.P65Warnings.ca.gov.

FEP Convoluted Tubing

Series: CV03 and AMS-T-81914/3 and AMS-T-81914/4



Features

- Cuffs are sized on the I.D.
- Very flexible
- Long continuous lengths
- Translucent
- Chemically inert
- Good flexlife

Certifications/Compliance

AMS-T-81914

- ASTM D3296-03
- VW1 and UL-83 (natural)

SAE AS81914

- AMS-T-81914/3
- AMS-T-81914/4
- ASTM D3296-03
- FDA Compliant
- USP Class VI Compliant
- VW1 and UL-83 (natural)

Applications/Markets



- Fluid Transport
- Wire Harness
- Protection/Cable Core
- Laboratory
- Robotics

Order Information

Example: CV03-1-1/2-NT

CV03-1-1/2-NT – **Convoluted Tubing**

CV03-1-1/2-NT – **FEP**

CV03-1-1/2-NT – **Tube Size** in inches (1-1/2")

CV03-1-1/2-NT – **Natural**

Order Information

Example: 81914/3-1001-NT

81914/3-1001-NT – **AMS-T-81914 Convoluted**

81914/3-1001-NT – **FEP**

81914/3-1001-NT – **Helical Convolutions**

81914/3-1001-NT – **Size (01=0.187")**

81914/3-1001-NT – **Color (N=Natural)**

81914/3-1001-NT – **"T" is bulk** (for cut tubing remove "T", add length, ie. 81914/3-1001-N1200 = 187" Convo, natural, cut 12" long)

Standard Cuffs for **FEP Convo** are sized on the **I.D.**

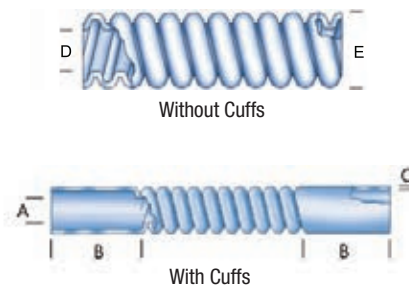

Without Cuffs

With Cuffs

Color Code

○	N	Natural	●	5	Green
●	0	Black	●	6	Blue
●	1	Brown	●	7	Violet
●	2	Red	●	8	Gray
●	3	Orange	○	9	White
●	4	Yellow			



WARNING

This product can expose you to chemicals including Tetrafluoroethylene, which is known to the State of California to cause cancer. For more information go to www.P65Warnings.ca.gov.

FEP Convuluted CV03
(Standard tubing is natural)

Part Number	Order Size inch	Standard Cuff I.D. "A"		Standard Cuff Length "B"		Wall Thickness "C"		Min. Inside Diameter "D"		Max. Inside Diameter "D"		Max. Outside Diameter "E"		**Min. Bend Radius	
		inch	mm	inch	mm	inch	mm	inch	mm	inch	mm	inch	mm	inch	mm
CV03-1/4-NT	1/4	1/4	6.35	3/4	19.1	0.020	0.508	0.251	6.38	0.265	6.73	0.405	10.3	0.365	9
CV03-5/16-NT	5/16	5/16	7.94	1	25.4	0.023	0.584	0.273	6.93	0.281	7.14	0.424	10.8	0.500	13
CV03-3/8-NT	3/8	3/8	9.53	1	25.4	0.023	0.584	0.364	9.25	0.375	9.53	0.530	13.5	0.875	22
CV03-1/2-NT	1/2	1/2	12.7	1	25.4	0.025	0.635	0.485	12.3	0.500	12.7	0.660	16.8	0.625	16
CV03-5/8-NT	5/8	5/8	15.9	1-1/4	31.8	0.025	0.635	0.609	15.5	0.625	15.9	0.780	19.8	1.500	38
CV03-3/4-NT	3/4	3/4	19.1	1-1/2	38.1	0.025	0.635	0.730	18.5	0.750	19.1	0.975	24.8	3.500	89
CV03-1.00-NT	1	1	25.4	2	50.8	0.030	0.762	0.975	24.8	1.000	25.4	1.260	32.0	2.250	57

** Minimum 36" length.

Notes

- Working Temperature: -100°F (-75°C) to +400°F (204°C)

Colors

- Natural, Translucent

FEP Convuluted Tubing (AMS-T-81914/3)

(Standard tubing is natural)

Part Number	MIL Spec	Maximum Inside Diameter		Minimum Inside Diameter		Maximum Outside Diameter		Maximum Wall Thickness		Minimum Bend Radius		Pitch ±1	Weight	
		inch	mm	inch	mm	inch	mm	inch	mm	inch	mm		lb./100 ft.	kg./100 mtr.
81914/3-1001-NT	-01	0.187	4.75	0.181	4.60	0.320	8.13	0.018	0.457	1/2	13	8	1.5	2.23
81914/3-1002-NT	-02	0.281	7.14	0.273	6.93	0.414	10.5	0.018	0.457	3/4	19	8	1.7	2.53
81914/3-1003-NT	-03	0.312	7.93	0.306	7.77	0.450	11.4	0.018	0.457	3/4	19	8	1.9	2.83
81914/3-1004-NT	-04	0.375	9.53	0.364	9.25	0.510	13.0	0.018	0.457	7/8	22	8	2.2	3.27
81914/3-1005-NT	-05	0.437	11.1	0.427	10.9	0.571	14.5	0.018	0.457	7/8	22	8	3.1	4.61
81914/3-1006-NT	-06	0.500	12.7	0.485	12.3	0.650	16.5	0.023	0.584	1-1/4	32	7	4.0	5.95
81914/3-1007-NT	-07	0.625	15.9	0.608	15.4	0.770	19.6	0.023	0.584	1-1/2	38	7	4.8	7.14
81914/3-1008-NT	-08	0.750	19.1	0.730	18.5	0.930	23.6	0.023	0.584	1-3/4	44	6	6.1	9.07
81914/3-1009-NT	-09	0.875	22.2	0.860	21.8	1.073	27.3	0.023	0.584	2	51	5	7.0	10.4
81914/3-1010-NT	-10	1.000	25.4	0.975	24.8	1.226	31.1	0.023	0.584	2.370	60	5	8.5	12.7
81914/3-1011-NT	-11	1.125	28.6	1.105	28.1	1.390	35.3	0.023	0.584	2.370	60	5	9.3	13.8
81914/3-1012-NT	-12	1.250	31.8	1.210	30.7	1.539	39.1	0.023	0.584	2-3/4	70	4	10.9	16.2

FEP convuluted tubing is provided in NATURAL without cuffs direct from the factory. Natural part numbers are designated with "NT" after the Mil Spec number (i.e. 81914/3-1014-NT).

Notes

- Working Temperature: 392°F (200°C)
- Tubing is provided in natural without cuffs direct from inventory
- Also available in close convolution 81914/4
- Custom packaging, sizes, lengths, cuffs and colors are quoted upon request

Colors

- Natural, Translucent
- Colors available as custom run, see color code table

When ordering convuluted tubing in colors, the "N" designation for natural should be replaced by the correct color designator;

i.e., 81914/3-1001-0T (black bulk tubing)
i.e., 81914/3-1001-01200 (black tubing - 12 inches long)



WARNING

This product can expose you to chemicals including Tetrafluoroethylene, which is known to the State of California to cause cancer. For more information go to www.P65Warnings.ca.gov.

FEP/PFA Corrugated

Extra Flexible Fluoropolymer Tubing, Series CR03

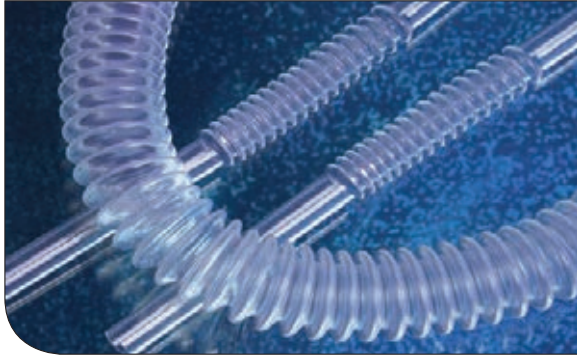

Features

- Capable of turning sharp corners without reducing the inside diameter of the tube
- Extremely flexible
- Kink resistant
- Non stick surface allows for easy cleaning
- Excellent clarity
- Chemically inert
- Available in FEP, PFA and High Purity PFA

Applications/Markets



- Vacuum Applications
- Robotics
- Instrumentation
- DNA Sequencer
- Fluid Transfer
- Pharmaceutical
- Wet Bench

Certifications/Compliance

- FEP - ASTM D3296-03
- PFA - ASTM D3307-10
- FDA Compliant
- USP Class VI Compliant
- VW1 and UL-83 (natural)

Order Information

Example: CR03-3/4-NT

CR03-3/4-NT – Corrugated Tubing

CR03-3/4-NT – FEP

CR03-3/4-NT – Tube I.D. when cuffed in inches (3/4")

CR03-3/4-NT – Color (N=Natural)

CR03-3/4-NT – “T” is bulk - for cuffed tubing add length, ie. CR03-3/4-N1200 = 1" Corr, natural, cut 12" long

Colors

- ○ Natural, Translucent

Notes

- Working Temperature: -100°F (-75°C) to +200°F (93°C) @ 0 pressure -
For higher temperatures, request PFA Corrugated -100°F (-75°C) to +300°F (148°C) @ 0 pressure
- Vacuum Service: 29.9 IN. Hg (759M Hg)
- Extension-Compression Length Ratio: Approximately 2:1
- Tubing is provided in natural in custom lengths with a maximum length of 12 feet/3 meters
- Corrugated tubing is also available in specialty configurations where corrugated and straight tubing run intermittently along the tube
- Custom packaging, sizes, lengths and colors are quoted upon request



WARNING

This product can expose you to chemicals including Tetrafluoroethylene, which is known to the State of California to cause cancer. For more information go to www.P65Warnings.ca.gov.

FEP Tex-Flex® Corrugated

Part Number	Size To Order	Maximum Cuff I.D. "A"		Standard Cuff Length "B"		Wall Thickness "C"		Ref. Outside Diameter "D"		Corrugated Length "E"	Minimum Bend Radius	
		inch	mm	inch	mm	inch	mm	inch	mm		±1	inch
CR03-1/4-NT	1/4	0.250	6.35	3/4	19.1	0.015	0.38	0.375	9.53	To be specified at time of order	0.125	3.18
CR03-3/8-NT	3/8	0.375	9.53	1	25.4	0.020	0.51	0.625	15.9		0.187	4.76
CR03-1/2-NT	1/2	0.500	12.7	1	25.4	0.025	0.64	0.750	19.0		0.250	6.35
CR03-5/8-NT	5/8	0.625	15.9	1	25.4	0.025	0.64	0.938	23.8		0.312	7.94
CR03-3/4-NT	3/4	0.750	19.1	1-1/2	38.1	0.030	0.76	1.063	26.9		0.375	9.53
CR03-7/8-NT	7/8	0.875	22.2	1-1/2	38.1	0.030	0.76	1.250	31.8		0.438	11.1
CR03-1.00-NT	1	1.000	24.8	2	50.8	0.035	0.89	1.438	36.5		0.500	12.7
CR03-1.25-NT	1-1/4	1.250	31.8	2	50.8	0.035	0.89	1.625	41.3		0.625	15.9
CR03-1.50-NT	1-1/2	1.500	38.1	2	50.8	0.035	0.89	1.813	46.1		0.750	19.1
CR03-2.00-NT	2	2.000	50.8	2	50.8	0.040	1.02	2.625	66.7		1.000	25.4
CR03-2.50-NT	2-1/2	2.5000	63.8	2-1/2	63.5	0.070	1.78	3.360	85.3		2.500	63.5

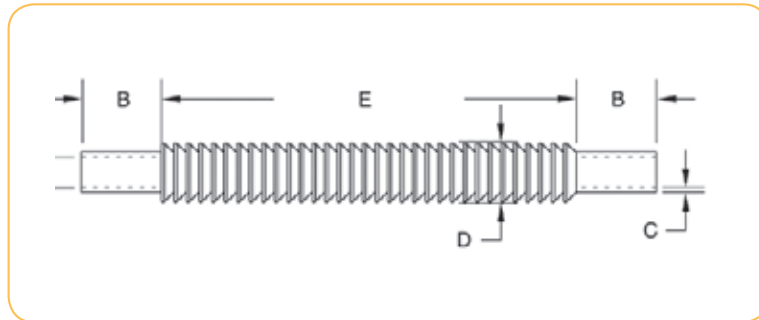

WARNING

This product can expose you to chemicals including Tetrafluoroethylene, which is known to the State of California to cause cancer. For more information go to www.P65Warnings.ca.gov.

B Tubing Fluoropolymer

C Coiled Air Hose & Fittings

D Transportation

E Fittings

F Tooling, Equipment & Accessories

G General Technical

Retractable Coiled Tubing

Single or Dual Containment, Series 703, 704, 705



Features

- Extremely flexible
- Excellent clarity
- Chemically inert
- Low coefficient of friction
- Self extinguishing
- Non-wetting
- Available in FEP, PFA and High Purity PFA

Certifications/Compliance

- FEP - ASTM D3296-03
- PFA - ASTM D3307-10
- FDA Compliant
- USP Class VI Compliant
- VW1 and UL-83 (natural)

Applications/Markets



- Fluid Handling
- Wet Bench
- Lab Equipment
- Gas Dispensing
- Medical

Order Information

Example: 704-0312062-xx0012

704-0312062-xx0012 – **Retractable tubing**

704-0312062-xx0012 – **PFA**

704-**0312062**-xx0012 – **Tube O.D.** in inches (**3/16"**)

704-0312**062**-xx0012 – **Wall (0.062")**

704-0312062-**xx**0012 – **Custom Options** (when needed)

704-0312062-xx**0012** – **Length 12"**

Fittings

Fittings available for sizes 3/16" up to 1/2"

Parker Fittings available from:
Fluid System Connectors Division
Otsego, MI

(269) 692-6555

(269) 692-6634 FAX

FSC Product Families:

- Compression
- Compress-Align®
- TrueSeal™

Colors

- ○ Natural, Translucent

Notes

- Working Temperature: -100°F (-75°C) to +200°F (93°C) @ 0 pressure. For higher temperatures, request PFA -100°F (-75°C) to +300°F (148°C) @ 0 pressure; above these temperatures, the coils dimensions are not stable and the coils will lose their shape
- Wall thickness of tubing .062"/1.57mm
- "X" denotes resin type - Replace "X" with 3 for FEP, 4 for PFA and 5 for HP PFA
- "xx" denotes custom options - Use when needed
- Standard left/right tail length is 6 inches
- Custom packaging, sizes, lengths and colors are quoted upon request



WARNING

This product can expose you to chemicals including Tetrafluoroethylene, which is known to the State of California to cause cancer. For more information go to www.P65Warnings.ca.gov.

Retractable Tubing

Part Number	Size To Order O.D. x I.D.	Coil Inside Diameter		Retracted Length "A"		Extended Length	
		inch	mm	inch	mm	inch	mm
70X-0188062-xx0003	3/16" x 1/16"	0.750	19.1	3	76	12	305
70X-0188062-xx0006	3/16" x 1/16"	0.750	19.1	6	152	24	610
70X-0188062-xx0012	3/16" x 1/16"	0.750	19.1	12	305	48	1219
70X-0188062-xx0018	3/16" x 1/16"	0.750	19.1	18	457	72	1829
70X-0250062-xx0003	1/4" x 1/8"	1	25.4	3	76	12	305
70X-0250062-xx0006	1/4" x 1/8"	1	25.4	6	152	24	610
70X-0250062-xx0012	1/4" x 1/8"	1	25.4	12	305	48	1219
70X-0250062-xx0018	1/4" x 1/8"	1	25.4	18	457	72	1829
70X-0312062-xx0003	5/16" x 3/16"	1.625	41.3	3	76	12	305
70X-0312062-xx0006	5/16" x 3/16"	1.625	41.3	6	152	24	610
70X-0312062-xx0012	5/16" x 3/16"	1.625	41.3	12	305	48	1219
70X-0312062-xx0018	5/16" x 3/16"	1.625	41.3	18	457	72	1829
70X-0375062-xx0003	3/8" x 1/4"	1.625	41.3	3	76	12	305
70X-0375062-xx0006	3/8" x 1/4"	1.625	41.3	6	152	24	610
70X-0375062-xx0012	3/8" x 1/4"	1.625	41.3	12	305	48	1219
70X-0375062-xx0018	3/8" x 1/4"	1.625	41.3	18	457	72	1829
70X-0438062-xx0003	7/16" x 5/16"	3	76.2	3	76	12	305
70X-0438062-xx0006	7/16" x 5/16"	3	76.2	6	152	24	610
70X-0438062-xx0012	7/16" x 5/16"	3	76.2	12	305	48	1219
70X-0500062-xx0003	1/2" x 3/8"	3	76.2	3	76	12	305
70X-0500062-xx0006	1/2" x 3/8"	3	76.2	6	152	24	610
70X-0500062-xx0012	1/2" x 3/8"	3	76.2	12	305	48	1219

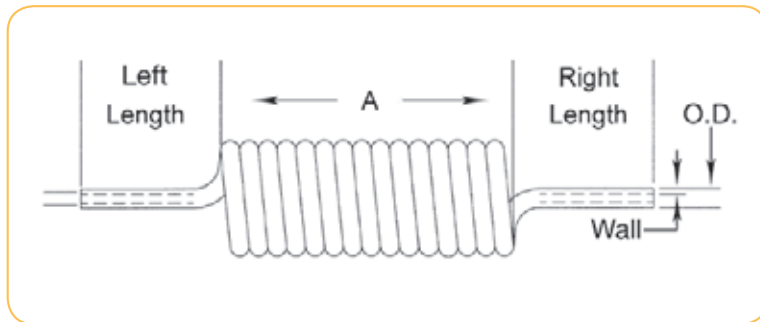

WARNING

This product can expose you to chemicals including Tetrafluoroethylene, which is known to the State of California to cause cancer. For more information go to www.P65Warnings.ca.gov.

PFA Tubing

Series Fractional & Metric: 104, 204



Features

- Virgin Perfluoroalkoxy
- Translucent
- High purity resins available
- Low permeability
- Exceptional heat resistance
- Chemically inert
- Long continuous lengths
- Low coefficient of friction
- Self extinguishing
- Non-wetting
- Non leaching

Certifications/Compliance

- ASTM D3307-10
- VW1 and UL-83 (natural)
- FDA Compliant
- USP Class VI Compliant

Applications/Markets



- Air Sampling
- Gas Sampling
- Fluid Transfer
- Laboratory
- Wet Bench
- Flow Monitoring
- Steam Plant

Order Information

Example: 104-0188062-NT-100

104-0188062-NT-100 – Fractional

104-0188062-NT-100 – PFA

104-0188062-NT-100 – Tube O.D. in inches (3/16")

104-0188062-NT-100 – Tube Wall Thickness in inches (.062")

104-0188062-NT-100 – Natural

104-0188062-NT-100 – Package Quantity in feet (100')

Fittings

Fittings available for sizes 3/32" up to 1"

Parker Fittings available from:
Fluid System Connectors Division
Otsego, MI (269) 692-6555 (269) 692-6634 FAX

FSC Product Families:

- Compression
- Compress-Align®
- Metric Compression
- TrueSeal™

Notes

- Working Temperature: -100°F (-75°C) to +500°F (260°C)
- Working pressure calculated using a Design Factor of 4 at 73°F (23°C)
- Custom packaging and sizes are quoted upon request

Options

- Smoothbore
- Convoluted
- Corrugated
- Retractable Coils
- Heat Shrink

Colors

- ○ Natural, Translucent
- Colors available as custom run, see color code table

Color Code					
○	N	Natural	●	5	Green
●	0	Black	●	6	Blue
●	1	Brown	●	7	Violet
●	2	Red	●	8	Gray
●	3	Orange	○	9	White
●	4	Yellow			

PFA Tubing (Series 104, 204) Maximum Working Pressure (bar)

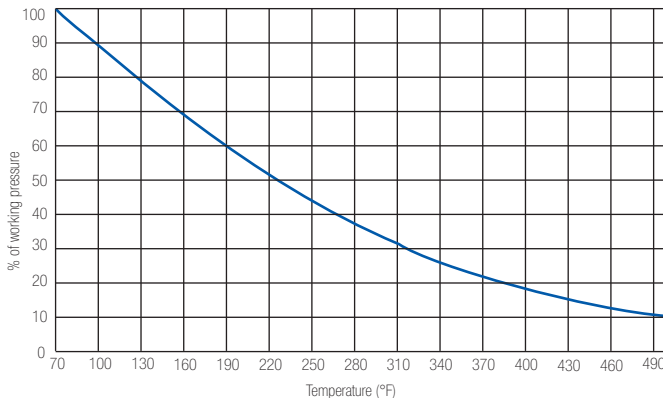

WARNING

This product can expose you to chemicals including Tetrafluoroethylene, which is known to the State of California to cause cancer. For more information go to www.P65Warnings.ca.gov.

104 PFA Industrial Wall Fractional Size Tubing

Part Number	Order Size	Nominal O.D.				Nominal I.D.				Reference Wall		Working Pressure		Burst Pressure		Min. Bend Radius		Vac. Rating	Weight	
		inch	tol.	mm	tol.	inch	tol.	mm	tol.	inch	mm	psi 73°F	bar 23°C	psi 73°F	bar 23°C	inch	mm		at 73°F	lb. per ft.
#																				
104-0094031	3/32	0.094	±0.004	2.40	±0.102	0.031	±0.002	0.79	±0.051	0.031	0.79	680	47	2720	188	0.250	6	28	0.006	0.009
104-0125031	1/8	0.125	±0.004	3.18	±0.102	0.064	±0.004	1.63	±0.102	0.031	0.79	500	34	2000	138	0.375	10	28	0.009	0.013
104-0156031	5/32	0.157	±0.005	3.99	±0.127	0.094	±0.003	2.39	±0.076	0.031	0.79	390	27	1560	108	0.625	16	28	0.011	0.016
104-0188031	3/16	0.188	±0.005	4.78	±0.127	0.125	±0.005	3.18	±0.127	0.031	0.79	320	22	1280	88	0.625	16	28	0.014	0.021
104-0250031	1/4	0.250	±0.005	6.35	±0.127	0.188	±0.005	4.78	±0.127	0.031	0.79	230	16	920	63	0.875	22	28	0.020	0.030
104-0312031	5/16	0.312	±0.005	7.92	±0.127	0.250	±0.005	6.35	±0.127	0.031	0.79	180	12	720	50	1.750	44	28	0.025	0.037
104-0375031	3/8	0.375	±0.005	9.52	±0.127	0.312	±0.005	7.92	±0.127	0.031	0.79	140	10	560	39	3.250	83	28	0.031	0.046
104-0438031	7/16	0.438	±0.005	11.13	±0.127	0.375	±0.005	9.53	±0.127	0.031	0.79	120	8	480	33	3.250	83	28	0.037	0.055
104-0500031	1/2	0.500	±0.005	12.70	±0.127	0.438	±0.005	11.13	±0.127	0.031	0.79	100	7	400	28	4.750	121	28	0.043	0.064
104-0563031	9/16	0.563	±0.006	14.30	±0.152	0.500	±0.006	12.70	±0.152	0.031	0.79	80	6	320	22	5.000	127	28	0.048	0.071

104 PFA Heavy Wall Fractional Size Tubing

Part Number	Order Size	Nominal O.D.				Nominal I.D.				Reference Wall		Working Pressure		Burst Pressure		Min. Bend Radius		Vac. Rating	Weight	
		inch	tol.	mm	tol.	inch	tol.	mm	tol.	inch	mm	psi 73°F	bar 23°C	psi 73°F	bar 23°C	inch	mm		at 73°F	lb. per ft.
#																				
104-0188062	3/16	0.188	±0.005	4.78	±0.127	0.062	±0.005	1.57	±0.127	0.062	1.57	680	47	2720	188	0.500	13	28	0.023	0.034
104-0250040	1/4	0.250	±0.005	6.35	±0.127	0.170	±0.005	4.32	±0.127	0.040	1.02	300	21	1200	83	0.875	22	28	0.025	0.037
104-0250047	1/4	0.250	±0.005	6.35	±0.127	0.156	±0.005	3.96	±0.127	0.047	1.19	370	26	1480	102	1.000	25	28	0.028	0.042
104-0250062	1/4	0.250	±0.005	6.35	±0.127	0.125	±0.005	3.18	±0.127	0.062	1.57	500	34	2000	138	0.500	13	28	0.034	0.051
104-0312062	5/16	0.312	±0.005	7.92	±0.127	0.188	±0.005	4.78	±0.127	0.062	1.57	390	27	1560	108	0.750	19	28	0.045	0.067
104-0375062	3/8	0.375	±0.005	9.52	±0.127	0.250	±0.005	6.35	±0.127	0.062	1.57	320	22	1280	88	1.250	32	28	0.057	0.085
104-0438062	7/16	0.438	±0.005	11.13	±0.127	0.312	±0.005	7.92	±0.127	0.062	1.57	270	19	1080	74	2.625	67	28	0.068	0.101
104-0500062	1/2	0.500	±0.005	12.70	±0.127	0.375	±0.005	9.53	±0.127	0.062	1.57	230	16	920	63	3.000	76	28	0.079	0.118
104-0750062	3/4	0.750	±0.006	19.05	±0.152	0.625	±0.006	15.88	±0.152	0.062	1.57	140	10	560	39	6.000	152	28	0.125	0.186
104-1000062	1	1.000	±0.010	25.40	±0.254	0.875	±0.010	22.22	±0.254	0.062	1.57	100	7	400	28	8.000	203	28	0.170	0.253

204 Metric PFA Tubing

Part Number	Order Size	Nominal O.D.				Nominal I.D.				Reference Wall		Working Pressure		Burst Pressure		Min. Bend Radius		Vac. Rating	Weight	
		mm	tol.	inch	tol.	mm	tol.	inch	tol.	mm	inch	bar 23°C	psi 73°F	bar 23°C	psi 73°F	mm	inch		at 73°F	kg. per m.
#																				
204-0400100	4	4	±0.11	.157	±0.004	2	±0.11	.079	±0.250	1	0.039	34	500	138	2000	6	0.250	28	0.020	0.014
204-0600100	6	6	±0.11	.236	±0.004	4	±0.11	.157	±0.004	1	0.039	22	320	88	1280	25	1.000	28	0.034	0.023
204-0800100	8	8	±0.11	.315	±0.004	6	±0.11	.236	±0.004	1	0.039	16	230	63	920	51	2.000	28	0.047	0.032
204-1000100	10	10	±0.11	.393	±0.004	8	±0.11	.315	±0.004	1	0.039	12	180	50	720	70	2.750	28	0.061	0.041
204-1200100	12	12	±0.15	.472	±0.006	10	±0.15	.393	±0.006	1	0.039	10	140	39	560	89	3.500	28	0.074	0.050



WARNING

This product can expose you to chemicals including Tetrafluoroethylene, which is known to the State of California to cause cancer. For more information go to www.P65Warnings.ca.gov.

High Purity PFA Tubing

Series Fractional & Metric: 105, 205

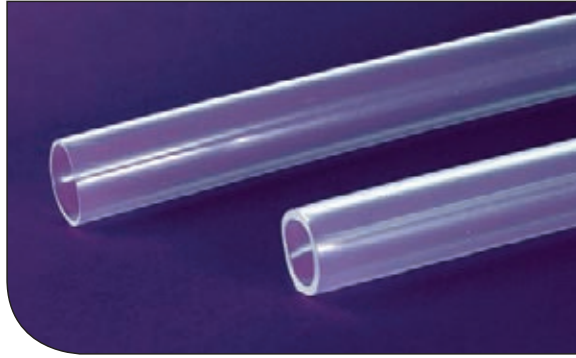

Features

- Withstands corrosive surfactants for longer periods of time
- Highest molecular weight available
- Lowest level of extractables
- Low permeability
- Exceptional heat resistance
- Chemically inert
- Long continuous lengths
- Low coefficient of friction
- Self extinguishing
- Non leaching

Certifications/Compliance

- ASTM D3307-10
- VW1 and UL-83 (natural)
- FDA Compliant
- USP Class VI Compliant

Applications/Markets



- Flow Monitoring
- Gas Transfer
- Food
- Wet Bench
- DI Water Dispensers
- DI Recirculators
- Heat Exchangers
- Pure Chemical Dispensers
- High Purity Applications

Order Information

Example: 105-0375031-NT-100

105-0375031-NT-100 – **Fractional**

105-0375031-NT-100 – **High Purity PFA**

105-**0375031**-NT-100 – **Tube O.D.** in millimeters (**3/8"**)

105-0375**031**-NT-100 – **Tube Wall Thickness** in millimeters (**.031"**)

105-0375031-**NT**-100 – **Natural**

105-0375031-NT-**100** – **Package Quantity** in feet (**100'**)

Notes

- Working Temperature: -100°F (-75°C) to +500°F (260°C)
- Working pressure calculated using a Design Factor of 4 at 73°F (23°C)
- Custom packaging and sizes are quoted upon request

Options

- Smoothbore
- Convoluted
- Corrugated
- Retractable Coils

Colors

- Natural, Translucent

Fittings

Fittings available for sizes 4mm up to 12mm

Parker Fittings available from:
Fluid System Connectors Division
Otsego, MI

(269) 692-6555

(269) 692-6634 FAX

FSC Product Families:

- Compression
- Compress-Align®
- Metric Compression
- TrueSeal



WARNING

This product can expose you to chemicals including Tetrafluoroethylene, which is known to the State of California to cause cancer. For more information go to www.P65Warnings.ca.gov.

105 High Purity PFA Industrial Wall Fractional Size Tubing

Part Number	Order Size	Nominal O.D.				Nominal I.D.				Reference Wall		Working Pressure		Burst Pressure		Min. Bend Radius		Vac. Rating	Weight	
		inch	inch	tol.	mm	tol.	inch	tol.	mm	tol.	inch	mm	psi 73°F	bar 23°C	psi 73°F	bar 23°C	inch		mm	at 73°F
#																				
105-0125031	1/8	0.125	±0.004	3.18	±0.102	0.064	±0.004	1.63	±0.102	0.031	0.79	500	34	2000	138	0.500	13	28	0.009	0.013
105-0188031	3/16	0.188	±0.005	4.78	±0.127	0.125	±0.005	3.18	±0.127	0.031	0.79	320	22	1280	88	0.750	19	28	0.014	0.021
105-0250031	1/4	0.250	±0.005	6.35	±0.127	0.188	±0.005	4.78	±0.127	0.031	0.79	230	16	920	63	1.000	25	28	0.020	0.030
105-0375031	3/8	0.375	±0.005	9.52	±0.127	0.312	±0.005	7.92	±0.127	0.031	0.79	140	10	560	39	3.500	89	28	0.031	0.047

B Tubing Fluoropolymer

105 High Purity PFA Heavy Wall Fractional Size Tubing

Part Number	Order Size	Nominal O.D.				Nominal I.D.				Reference Wall		Working Pressure		Burst Pressure		Min. Bend Radius		Vac. Rating	Weight	
		inch	inch	tol.	mm	tol.	inch	tol.	mm	tol.	inch	mm	psi 73°F	bar 23°C	psi 73°F	bar 23°C	inch		mm	at 73°F
#																				
105-0250040	1/4	0.250	±0.005	6.35	±0.127	0.170	±0.005	4.32	±0.127	0.040	1.02	300	21	1200	83	0.938	24	28	0.025	0.037
105-0250047	1/4	0.250	±0.005	6.35	±0.127	0.156	±0.005	3.96	±0.127	0.047	1.19	370	26	1480	102	0.500	13	28	0.028	0.042
105-0250062	1/4	0.250	±0.005	6.35	±0.127	0.125	±0.005	3.18	±0.127	0.062	1.57	500	34	2000	138	0.625	16	28	0.034	0.051
105-0375062	3/8	0.375	±0.005	9.52	±0.127	0.250	±0.005	6.35	±0.127	0.062	1.57	320	22	1280	88	1.125	29	28	0.057	0.085
105-0500062	1/2	0.500	±0.005	12.70	±0.127	0.375	±0.005	9.53	±0.127	0.062	1.57	230	16	920	63	2.250	57	28	0.079	0.119
105-0750062	3/4	0.750	±0.006	19.05	±0.152	0.625	±0.006	15.88	±0.152	0.062	1.57	140	10	560	39	4.250	108	28	0.125	0.186
105-1000062	1	1.000	±0.010	25.40	±0.254	0.875	±0.010	22.22	±0.254	0.062	1.57	100	7	400	28	8.000	203	*	0.170	0.254

C Coiled Air Hose & Fittings

D Transportation

205 Metric High PFA Tubing

Part Number	Order Size	Nominal O.D.				Nominal I.D.				Reference Wall		Working Pressure		Burst Pressure		Min. Bend Radius		Vac. Rating	Weight	
		mm	mm	tol.	inch	tol.	mm	tol.	inch	tol.	mm	inch	bar 23°C	psi 73°F	bar 23°C	psi 73°F	mm		inch	at 73°F
#																				
205-0300100	3	3	±0.11	0.118	±0.004	1	±0.11	0.039	±0.004	1	0.039	47	680	188	2720	13	0.500	28	0.014	0.009
205-0400100	4	4	±0.11	0.157	±0.004	2	±0.11	0.079	±0.004	1	0.039	34	500	138	2000	13	0.500	28	0.020	0.020
205-0600100	6	6	±0.11	0.236	±0.004	4	±0.11	0.157	±0.004	1	0.039	22	320	88	1280	22	0.875	28	0.034	0.023
205-0800100	8	8	±0.11	0.315	±0.004	6	±0.11	0.236	±0.004	1	0.039	16	230	63	920	35	1.375	28	0.047	0.032
205-1000100	10	10	±0.11	0.393	±0.004	8	±0.11	0.315	±0.004	1	0.039	12	180	50	720	51	2.000	28	0.061	0.041
205-1200100	12	12	±0.15	0.472	±0.006	10	±0.15	0.394	±0.006	1	0.039	10	140	39	560	89	3.500	28	0.074	0.050

E Fittings

F Tooling, Equipment & Accessories

G General Technical



WARNING

This product can expose you to chemicals including Tetrafluoroethylene, which is known to the State of California to cause cancer. For more information go to www.P65Warnings.ca.gov.

Notes

A Hose	
Tubing Fluoropolymer	
Coiled Air Hose & Fittings	
D Transportation	
F Fittings	
Tooling, Equipment & Accessories	
G General Technical	

Air Hose and Fittings

Fast-Stor®

NoMar® Fast-Stor®



Table of Contents

Hose & Tubing

Introduction.....C-4

Fast-Stor® Air HoseC-6

NoMar® Fast-Stor® Urethane Coiled Assemblies, AUFSC-8

NoMar® Fast-Stor® High Durometer Urethane Coiled Assemblies, AHUFSC-10

Fittings

Fast-Stor® FittingsC-7



NoMar® Fast-Stor® FittingsC-11

Technical

Size Selection Procedure.....C-5

Coiled Air Hose Visual Index

Fast-Stor® Coiled Air Hose Assembly	Air Hose Assembly
	 C-6

Fast-Stor® Fittings & Replacement Parts	MC Male Connector	ML Live Male Pipe Swivel
	 C-7	 C-7

NoMar® Fast-Stor® Assemblies & Coils	AUFS Assemblies
	 C-8

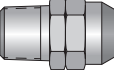
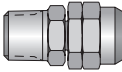
NoMar® Fast-Stor® Fittings	MCB Male Pipe Rigid	MLB Male Pipe Swivel
	 C-11	 C-11

AHUFs Coils	AHUFs Assemblies
	 C-10

A
Hose

B
Tubing

C
Coiled Air Hose
& Fittings

D
Transportation

E
Fittings

F
Tooling,
Equipment
& Accessories

G
General
Technical

Air Hose

Every hydraulic, pneumatic and lubrication system requires some form of tube line fabrication and fitting installation for completion. Proper fabrication and installation are essential for the overall efficiency, leak free performance, and general appearance of any system.

Start by planning ahead. After sizing the tube lines and selecting the appropriate style of fitting, consider the following in the design of your system:

- Accessibility of joints
- Proper routing of lines
- Adequate tube line supports
- Available fabricating tools

Routing of Lines

Routing of lines is probably the most difficult, yet most significant, of these system design considerations. Proper routing involves getting a connecting line from one point to another through the most logical path.

Always try to leave fitting joints as accessible as possible. Hard to reach joints are hard to assemble and tighten properly. Inaccessible joints are also more difficult and time consuming to service.



Size Selection Procedure

Proper size selection is extremely important in choosing any air hose in order to prevent “starvation” of the air tool and to ensure maximum torque and tool speed. Starved tools don’t produce!

Steps in size selection:

1. Determine air flow rate and pressure required by following air-tool manufacturers recommendations.
2. Refer to “Air Flow Characteristics” graphs, shown below. Find air flow requirement in standard cubic feet per minute (SCFM) on vertical line to left of graph. Now follow horizontal line on same graph to determine total extended length of hose required. Follow vertical line above hose length to intersection with the horizontal air flow SCFM line.
3. Note pressure drop above curve nearest to intersection of SCFM and hose length lines. Pressure drop, subtracted from line pressure, equals “available pressure” at the selected SCFM flow rate and hose length.
4. If “available pressure” is below the tool manufacturers’ recommendations, refer to chart for successively larger hose sizes until an acceptable “available pressure” is found. Choose this size Fast-Stor® Air Hose for your application.
5. Refer to “working pressure vs. temperature” chart (pg. B-11) to be sure your application falls within the working range of Fast-Stor® Air Hose.

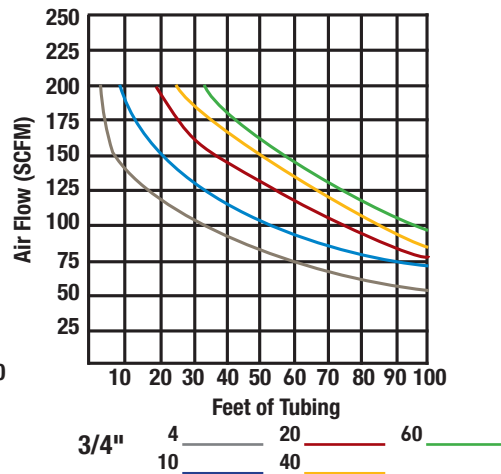
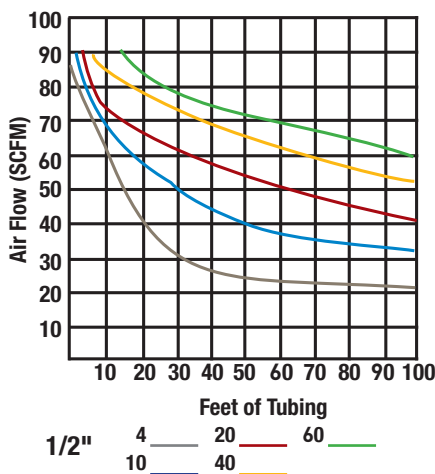
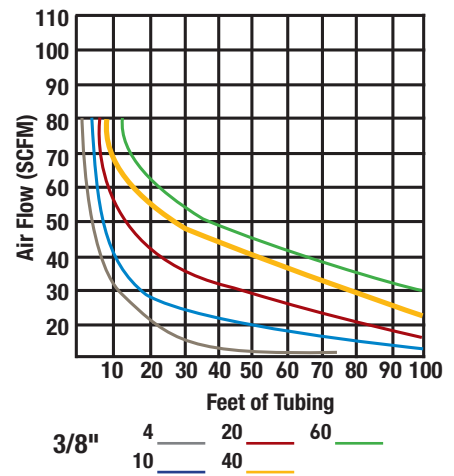
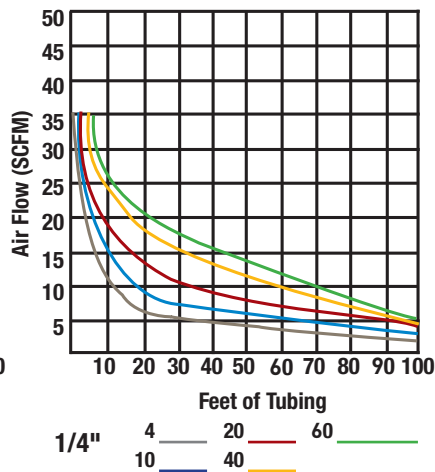
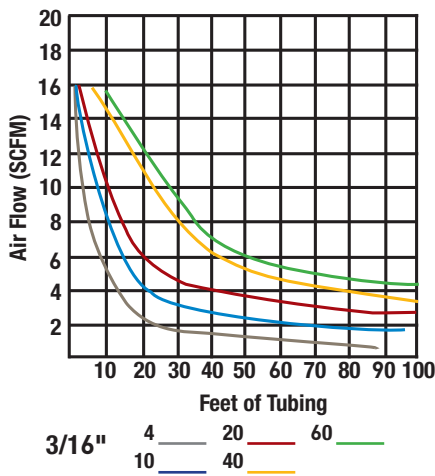

Actual working pressure charts are located in the tubing section on the specific product page.

Fast-Stor® Air Hose



Features

- Manufactured from tough, abrasion-resistant nylon
- Excellent memory characteristics over a wide temperature range
- Long service life in rugged applications
- Desirable Safety Yellow color per U.S. Government OSHA directives

Applications/Markets



- Blow Guns
- Construction
- Mfg. Air Drops
- Machine Tool Lubrication
- Water Hose

Fast-Stor® Assemblies

Popular Stock Assemblies

Assembly Part Number	Hose I.D.		Total Length		Working Length		Nominal Compact Length		Coil I.D.		Maximum Working Pressure 73°F/23°C		Minimum Burst at 73°F/23°C		End Fittings
	inch	mm	ft.	mtr.	ft.	mtr.	inch	mm	inch	mm	psi	MPa	psi	MPa	
#															
A0412-MC4-ML4*	1/4	6	12	3.7	9	2.7	4.3	109	3	76	225	1.55	680	4.69	1/4" NPT
A0425-MC4-ML4*	1/4	6	25	7.6	18	5.5	8.6	218	3	76	225	1.55	680	4.69	1/4" NPT
A0450-MC4-ML4	1/4	6	50	15.2	38	11.6	18.1	460	3	76	225	1.55	680	4.69	1/4" NPT
A0612-MC6-ML6*	3/8	10	12	3.7	9	2.7	4.3	109	4.5	114	225	1.55	680	4.69	3/8" NPT
A0625-MC6-ML6	3/8	10	25	7.6	18	5.5	8.5	216	4.5	114	225	1.55	680	4.69	3/8" NPT
A0650-MC6-ML6	3/8	10	50	15.2	38	11.6	17.9	455	4.5	114	225	1.55	680	4.69	3/8" NPT
A0812-MC8-ML8	1/2	13	12	3.7	9	2.7	4.3	109	6.5	165	225	1.55	680	4.69	1/2" NPT
A0825-MC8-ML8	1/2	13	25	7.6	18	5.5	8.5	216	6.5	165	225	1.55	680	4.69	1/2" NPT
A0850-MC8-ML8	1/2	13	50	15.2	38	11.6	16.8	427	6.5	165	225	1.55	680	4.69	1/2" NPT

Construction

Tube: Yellow Nylon
Spring Guard: Steel
Fittings: Brass

Notes

*Retail packaging available - Add "R" suffix when ordering

Operating Parameters

Service temperature range:
-40°F (-40°C) to +200°F (93°C)

Maximum working pressure based on safety
factor of 3:1 over burst



WARNING

This product can expose you to chemicals including Lead, which is known to the State of California to cause cancer and birth defects or other reproductive harm. For more information go to www.P65Warnings.ca.gov.

Fast-Stor® Fittings

Fittings for Fast-Stor® hose are constructed from heavy duty brass with built in insert-supports. Fitting bodies are SAE Standard sizes. Hose entry length into the fittings is the longest in the industry due to Parflex's SAE body design and size standardization, assuring a strong grip on the hose.

All fitting part numbers include body, nut, ferrule and spring guard.

MC – Male Connector

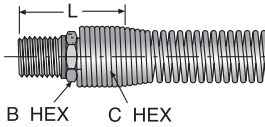

Part Number	Thread Size	Hose I.D.		L		B Hex		C Hex	
		inch	mm	inch	mm	inch	mm	inch	mm
#									
MC-04-2	1/8	1/4	6	1-3/8	35	9/16	14	9/16	14
MC-04-4	1/4	1/4	6	1-9/16	40	9/16	14	9/16	14
MC-06-6	3/8	3/8	10	1-13/16	46	11/16	17	13/16	21
MC-08-6	3/8	1/2	13	2-1/8	54	7/8	22	15/16	24
MC-08-8	1/2	1/2	13	2-1/8	54	7/8	22	15/16	24
*MC-12-12	3/4	3/4	19	2-1/4	57	1-1/4	32	1-3/8	35

*No spring guard required.

ML – Live Male Pipe Swivel

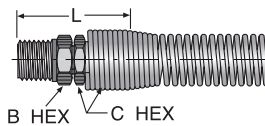

Part Number	Thread Size	Hose I.D.		L		B Hex		C Hex	
		inch	mm	inch	mm	inch	mm	inch	mm
#									
ML-04-4	1/4	1/4	6	1-9/16	40	9/16	14	9/16	14
ML-06-6	3/8	3/8	10	1-7/8	47	3/4	19	13/16	21
ML-08-8	1/2	1/2	13	2-3/8	60	5/8	22	15/16	24



WARNING

This product can expose you to chemicals including Lead, which is known to the State of California to cause cancer and birth defects or other reproductive harm. For more information go to www.P65Warnings.ca.gov.

Parflex NoMar® Fast-Stor® Assemblies AUFS



Features

- Manufactured from durable, abrasion-resistant Polyurethane
- Excellent memory characteristics over a wide temperature range

Applications/Markets



- Auto Repair

- Blow Guns

- Construction

- Carpentry

- Furniture Manufacturing

- Mfg. Air Drops

- Marine

- Water Hose



Urethane Fast-Stor® Assemblies

Includes live male end and rigid male end

Assembly Part Number	Hose O.D.		Hose I.D.		Working Length		Nominal Compact Length		Nominal Coil I.D.		Maximum Working Pressure 73°F/23°C		Minimum Burst at 73°F/23°C		End Fittings
	inch	mm	ft.	mtr.	ft.	mtr.	inch	mm	inch	mm	psi	MPa	psi	MPa	
#															
AUFS-42-TBLU-010	1/4	6	1/8	3	10	3	8.3	210	3/4	19	175	1.21	525	3.62	1/4" NPT
AUFS-42-TBLU-025	1/4	6	1/8	3	25	7.6	23.9	607	3/4	19	175	1.21	525	3.62	1/4" NPT
AUFS-64-TBLU-010*	3/8	10	1/4	6	8	3	5.6	142	1-3/4	44	180	1.24	540	3.72	1/4" NPT
AUFS-64-TBLU-015*	3/8	10	1/4	6	8	4.6	9.3	236	1-3/4	44	180	1.24	540	3.72	1/4" NPT
AUFS-64-TBLU-020	3/8	10	1/4	6	8	6.1	13	330	1-3/4	44	180	1.24	540	3.72	1/4" NPT
AUFS-64-TBLU-025*	3/8	10	1/4	6	8	7.6	16	406	1-3/4	44	180	1.24	540	3.72	1/4" NPT
AUFS-85-TBLU-010	1/2	13	21/64	8	8	3	5.5	140	2-1/2	64	150	1.03	450	3.10	3/8" NPT
AUFS-85-TBLU-015	1/2	13	21/64	8	15	4.6	9	229	2-1/2	64	150	1.03	450	3.10	3/8" NPT
AUFS-85-TBLU-020	1/2	13	21/64	8	20	6.1	12.5	317	2-1/2	64	150	1.03	450	3.10	3/8" NPT
AUFS-85-TBLU-025	1/2	13	21/64	8	25	7.6	16	406	2-1/2	64	150	1.03	450	3.10	3/8" NPT
AUFS-96-TBLU-010	9/16	17	3/8	10	10	3	6.1	155	2-1/2	64	140	0.97	420	2.90	3/8" NPT
AUFS-96-TBLU-015	9/16	17	3/8	10	15	4.6	9.9	251	2-1/2	64	140	0.97	420	2.90	3/8" NPT
AUFS-96-TBLU-020	9/16	17	3/8	10	20	6.1	13.7	348	2-1/2	64	140	0.97	420	2.90	3/8" NPT
AUFS-96-TBLU-025	9/16	17	3/8	10	25	7.6	17.5	444	2-1/2	64	140	0.97	420	2.90	3/8" NPT



WARNING

This product can expose you to chemicals including Lead, which is known to the State of California to cause cancer and birth defects or other reproductive harm. For more information go to www.P65Warnings.ca.gov.

Construction

Tube: Transparent Blue Polyurethane

Fittings: Brass

Operating Parameters

Service temperature range: -40°F (-40°C) to +180°F (82°C)

Notes

Pigtail Lengths - 16" swivel end, 8" rigid end

*Retail packaging available - Add "R" suffix when ordering

Colors

Color Code		
	TBLU	Transparent Blue

Order Information

Example: AUFS-64-TBLU-025

AUFS-64-TBLU-025 – Assembled Urethane Fast-Stor

AUFS-**64**-TBLU-025 – Tube O.D. (3/8")

AUFS-**64**-TBLU-025 – Tube I.D. (1/4")

AUFS-64-**TBLU**-025 – Color (Transparent Blue)

AUFS-64-TBLU-**025** – Total Length (25')



WARNING

This product can expose you to chemicals including Lead, which is known to the State of California to cause cancer and birth defects or other reproductive harm. For more information go to www.P65Warnings.ca.gov.

Parflex NoMar® Fast-Stor® Coiled Assembly AHUFS



Features

- Manufactured from durable, abrasion-resistant 98 Durometer Polyurethane
- Excellent memory characteristics over a wide temperature range
- Long service life in rugged applications

Applications/Markets



- Auto Repair
- Blow Guns
- Construction
- Carpentry
- Furniture Manufacturing
- Mfg. Air Drops
- Marine
- Water Hose

Includes live male end and rigid male end

Assembly Part Number	Hose I.D.		Total Length		Working Length		Nominal Compact Length		Nominal Coil I.D.		Maximum Working Pressure 73°F/23°C		Minimum Burst at 73°F/23°C		End Fittings
	inch	mm	ft.	mtr.	ft.	mtr.	inch	mm	inch	mm	psi	MPa	psi	MPa	
#															
AHUFS-6-xxx-015	3/8	10	1/4	6	15	4.6	13	330	1-1/4	32	180	1.24	375	2.59	1/4"
AHUFS-6-xxx-025	3/8	10	1/4	6	25	6.7	22	559	1-1/4	32	180	1.24	375	2.59	1/4"

Construction

Tube: 98 Durometer Polyurethane
Fitting: Brass

Operating Parameters

Service temperature range: -40°F (-40°C) to +180°F (82°C)

Maximum working pressure based on safety factor of 3:1 over burst.

Notes

xxx- Denotes Color

Retail packaging available - Add "R" suffix when ordering
Pigtail Lengths - 16" swivel end, 8" rigid end

Other sizes available upon request

Order Information

Example: AHUFS-6-BLK-015

AHUFS-6-BLK-015 – Assembled High Durometer Urethane Fast-Stor

AHUFS-6-BLK-015 – **Tube O.D. (3/8")**

AHUFS-6-**BLK**-015 – **Color (Black)**

AHUFS-6-BLK-**015** – **Total Length (15')**

Colors

Color Code		
	BLK	Black
	BLU	Blue
	RED	Red
	YEL	Yellow

Other colors available upon request - consult factory



WARNING

This product can expose you to chemicals including Lead, which is known to the State of California to cause cancer and birth defects or other reproductive harm. For more information go to www.P65Warnings.ca.gov.

Parflex NoMar® Fast-Stor® Fittings

(for reference only - not sold separately)

Parflex NoMar® Fast-Stor® fittings are manufactured from a heavy brass construction utilizing all standards for NPTF pipe threads. The engineered barb design generates the maximum gripping and sealing power when combined with the socket.

MCB Male Pipe Rigid

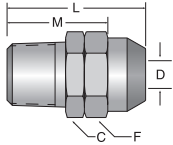

Part Number	Hose Part Number	Thread Size	Hose I.D.		L		Cutoff M		C Hex		F Hex	
			inch	mm	inch	mm	inch	mm	inch	mm	inch	mm
#	#											
MCB-4x2-2	UFS-42	1/8 NPT	0.12	3	1	25.4	0.74	18.8	7/16	11	7/16	11
MCB-4x2-4	UFS-42	1/4 NPT	0.12	3	1.16	29.5	0.9	22.9	9/16	14	7/16	11
MCB-6x4-4	UFS-64	1/4 NPT	0.23	5.8	1.16	29.5	0.9	22.9	5/8	16	5/8	16
MCB-6x4-6	UFS-64	3/8 NPT	0.23	5.8	1.2	30.5	0.94	23.9	3/4	19	5/8	16
MCB-8x5-6	UFS-85	3/8 NPT	0.27	6.9	1.29	32.8	0.99	25.1	3/4	19	3/4	19
MCB-9x6-6	UFS-96	3/8 NPT	0.31	7.9	1.47	37.3	1.1	27.9	7/8	22	7/8	22
MCB-9x6-8	UFS-96	1/2 NPT	0.32	8.1	1.61	40.9	1.24	31.5	7/8	22	7/8	22

MLB Male Live Swivel

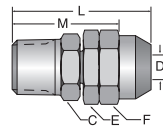

Part Number	Hose Part Number	Thread Size	Hose I.D.		L		Cutoff M		C Hex		E Hex		F Hex	
			inch	mm	inch	mm	inch	mm	inch	mm	inch	mm	inch	mm
#	#													
MLB-4x2-4	UFS-42	1/4 NPT	0.12	3	1.37	34.8	1.11	28.2	9/16	14	7/16	11	9/16	14
MLB-6x4-4	UFS-64	1/4 NPT	0.22	5.6	1.37	34.8	1.11	28.2	9/16	14	5/8	16	5/8	16
MLB-6x4-6	UFS-64	3/8 NPT	0.23	5.8	1.58	40.1	1.32	33.5	3/4	19	5/8	16	5/8	16
MLB-8x5-6	UFS-85	3/8 NPT	0.27	6.9	1.68	42.7	1.38	35.1	3/4	19	3/4	19	3/4	19
MLB-9x6-6	UFS-96	3/8 NPT	0.31	7.9	1.87	47.5	1.5	38.1	3/4	19	7/8	22	7/8	22
MLB-9x6-8	UFS-96	1/2 NPT	0.31	7.9	1.95	49.5	1.58	40.1	15/16	24	7/8	22	7/8	22



WARNING

This product can expose you to chemicals including Lead, which is known to the State of California to cause cancer and birth defects or other reproductive harm. For more information go to www.P65Warnings.ca.gov.

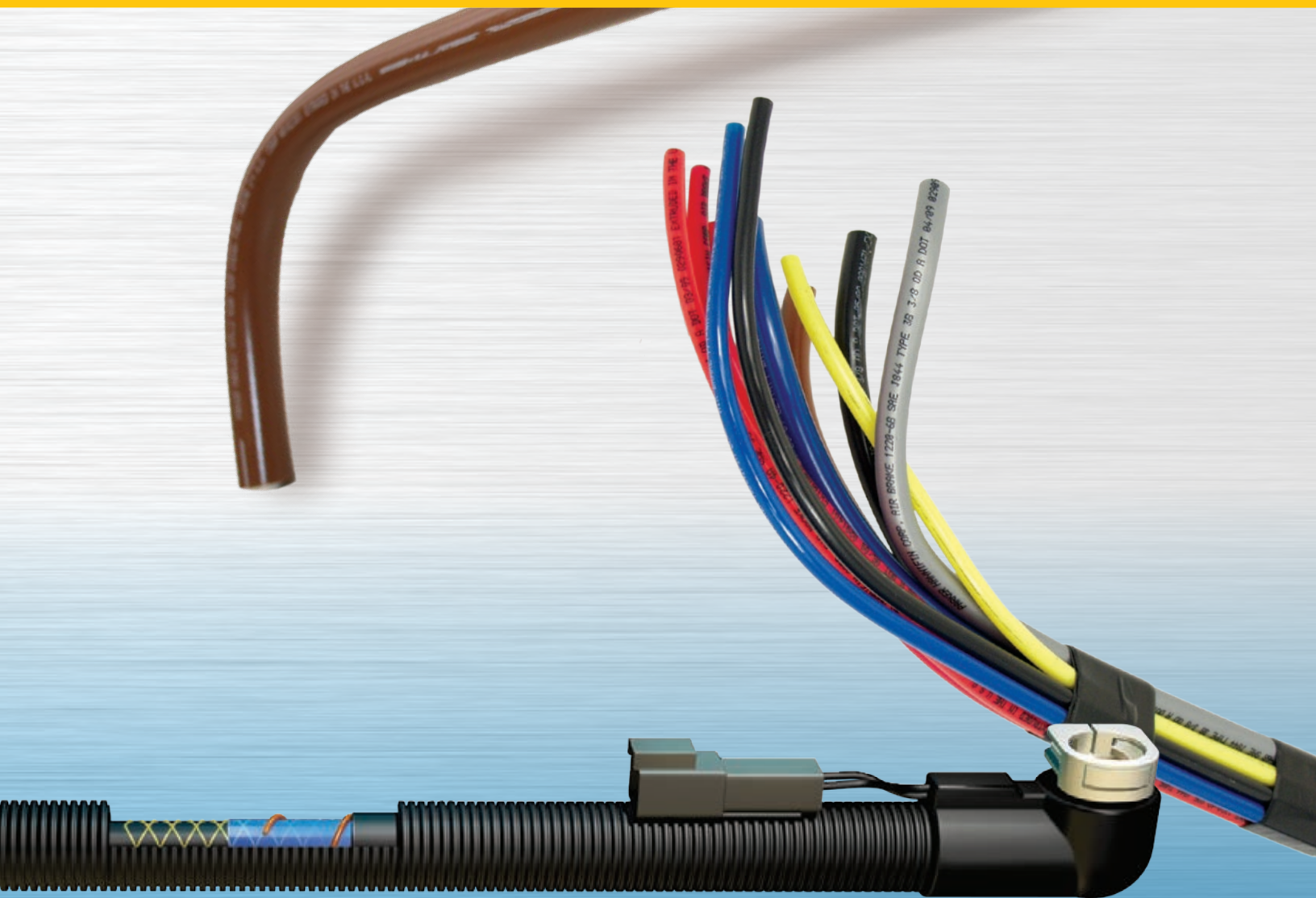

Table of Contents

Air Brake TubingD-4

BRAKCoil®D-8

Cut TubesD-11

Fifth Wheel SliderD-10

Formed Assemblies.....D-11

Formed HarnessesD-11

Formed Tubes and HosesD-11

HTFL Diesel Fuel Tubing, High TempD-6

Jacketed BundlesD-11













PFT-FL Diesel Fuel Tubing.....D-5

SCR HoseD-12

SliderCoil™D-9

Straight Harnesses.....D-11

Transportation Visual Index

Transportation Products	Air Brake Tubing  D-4	PFT-FL Diesel Fuel Tubing  D-5	HTFL High-Temperature Diesel Fuel Tubing  D-6	BRAKCoil®  D-8	SliderCoil™  D-9
	Fifth Wheel Slider  D-10	Cut Tubes  D-11	Formed Tubes & Hoses  D-11	Jacketed Bundles  D-11	Straight Harnesses  D-11
Formed Harnesses  D-11	SCR Hose  D-12				

Parflex Transportation Products

Hose
A

Tubing
B

Coiled Air Hose
& Fittings
C

Transportation
D

Fittings
E

Tooling,
Equipment
& Accessories
F

General
Technical
G

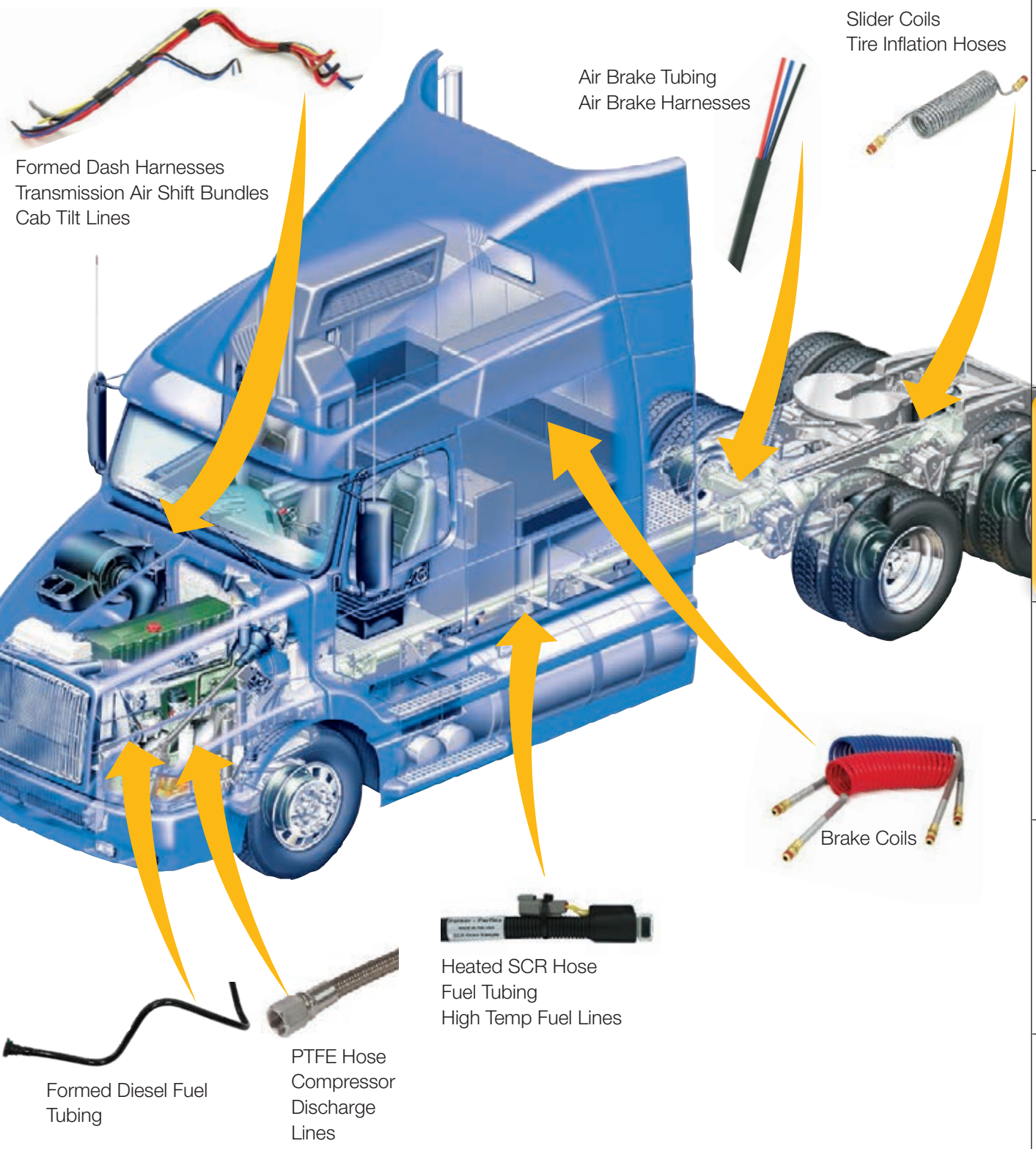

Nylon Air Brake Tubing



Features

- 100% pressure tested
- Excellent UV stability
- Abrasion resistant
- Kink resistant

Certifications

- Meets SAE Specification J844
- Meets DOT FMVSS 49CFR 571.106
*2A, 3A, and 5A are not DOT sizes

Applications/Markets



- Air brake lines

Part Number	Tube O.D.	Outside Diameter		Inside Diameter		Nominal Wall Thickness		Burst Pressure at 73°F /23°C		Minimum Bend Radius		Weight		Standard Reel		Standard Pallet		
		inch	mm	inch	mm	inch	mm	psi	bar	inch	mm	lbs./100 ft.	kg./31 mtr.	feet	meter	feet	meter	
#																		
PFT-2A-XXX-1000*	1/8	.125	3.2	.079	2.0	.023	0.6	1000	69.0	.370	9.4	.340	.154	1000	305	24,000	7315	
PFT-2.5-XXX-1000	5/32	.156	4.0	.092	2.3	.032	0.8	1200	82.7	.500	12.7	.570	.259	1000	305	24,000	7315	
PFT-3A-XXX-1000*	3/16	.188	4.8	.118	3.0	.035	0.9	1200	82.7	.750	19.1	.770	.349	1000	305	24,000	7315	
1120-4A-XXX-1000	1/4	.250	6.4	.170	4.3	.040	1.0	1200	82.7	1.00	25.4	1.21	.549	1000	305	24,000	7315	
PFT-5A-BLK-500*	5/16	.313	7.9	.232	5.9	.040	1.0	1000	69.0	1.25	31.8	1.57	.712	500	152	12,000	3658	
1120-6B-XXX-500	3/8	.375	9.5	.251	6.4	.062	1.6	1400	96.5	1.50	38.1	2.70	1.22	500	152	12,000	3658	
1120-8B-XXX-500	1/2	.500	12.7	.376	9.6	.062	1.6	950	65.5	2.00	50.8	3.90	1.77	500	152	6,000	3658	
1120-10B-XXX-250	5/8	.625	15.9	.441	11.2	.092	2.3	900	62.1	2.50	63.5	7.00	3.18	250	76	3,000	914	
1120-12B-XXX-250	3/4	.750	19.1	.566	14.4	.092	2.3	800	55.2	3.00	76.2	8.60	3.90	250	76	3,000	914	

Note: *2A, 3A, and 5A are not DOT sizes XXX represents color code

Construction

Material:
Type A - Single-wall extruded Nylon (polyamide)

Type B - Nylon (polyamide) core, fiber reinforcement,
Nylon (polyamide) cover/sheath

Operating Parameters

Temperature Range:
-40°F (-40°C) to +200°F (93°C)

Working Pressure: 150 psi (10.3 bar)

Fittings

Parker Fittings available from:
Fluid System Connectors Division
Otsego, MI
(269) 692-6555
(269) 694-4614 FAX

FSC Product Families:

- NTA
- Prestomatic
- PTC
- Air Brake
- PMT

Colors

Color Code		
●	BLK	Black
●	BLU	Blue
●	BRN	Brown
●	GRN	Green
●	ORG	Orange
●	PUR	Purple
●	RED	Red
●	SIL	Silver
●	TAN	Tan
●	YEL	Yellow
○	WHT	White



WARNING

This product can expose you to chemicals including Nickel compounds, which are known to the State of California to cause cancer. For more information go to www.P65Warnings.ca.gov.

Parflex Diesel Fuel Tubing

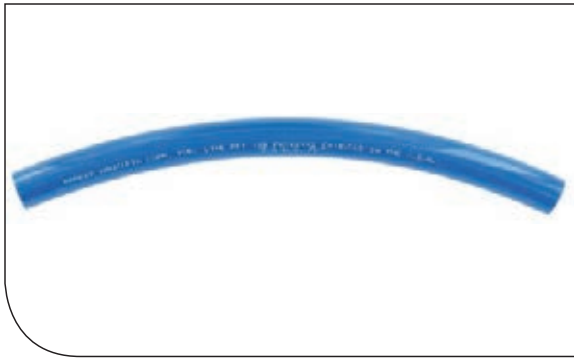

Features

- Nylon tubing designed for use in tractor, trailer and other mobile fuel systems
- Heat and light stabilized
- 100% quality controlled – 100% pressure tested
- Saves weight and labor in comparison with hose and hard-line tubing

Approvals

- Compatible with JP-5 (MIL-DTL-5624) and JP-8 (MIL-DTL-83133)
- Compatible with Biodiesel per Parflex PPB PL-18 hard-line tubing

Applications/Markets



- D.O.T. diesel fuel applications

Part Number	Nominal Tube O.D.		Nominal Tube I.D.		Minimum Bend Radius		Weight		Standard Reel	
	inch	mm	inch	mm	inch	mm	lbs./ft.	kg./mtr.	feet	meter
#										
PFT-4A-BLU-1000-FL	1/4	6	.170	4	1	25	.012	.017	1000	305
PFT-6B-BLU-500-FL	3/8	10	.251	6	1-1/2	38	.027	.040	500	152
PFT-8B-BLU-500-FL	1/2	13	.376	10	2	51	.039	.058	500	152
PFT-10B-BLU-250-FL	5/8	16	.441	11	2-1/2	64	.070	.104	250	76
PFT-12B-BLU-250-FL	3/4	19	.566	14	3	76	.086	.128	250	76

Construction

Heat and light stabilized seamless extruded nylon core reinforced with fibrous reinforcement and bonded with a protective blue nylon cover sheath

Operating Parameters

Temperature Range:

-40°F (-40°C) to +200°F (93°C)

Maximum Working Pressure: 150 psi (10.3 bar)

Do not exceed temperature and pressure ranges

Color

- BLU

Fittings

Parker Fittings available from:
Fluid System Connectors Division
Otsego, MI
(269) 692-6555
(269) 694-4614 FAX

FSC Product Families:

- NTA
- DF (Diesel Fuel Only)



WARNING

This product can expose you to chemicals including Nickel compounds, which are known to the State of California to cause cancer. For more information go to www.P65Warnings.ca.gov.

HTFL Diesel Fuel Line Tubing (High-Temperature)



Features

- Heat and UV stabilized
- For use in high temperature applications
- 100% pressure tested
- Light weight
- Pre-formed tubes available

Applications/Markets



Part Number	Nominal Tube O.D.		Nominal Tube I.D.		Nominal Wall Thickness		Working Pressure		Minimum Burst at 73°F / 23°C		Minimum Bend Radius		Weight		Standard Reel	
	inch	mm	inch	mm	inch	mm	psi	bar	psi	bar	inch	mm	lbs./ft.	kg./mtr	feet	meter
#																
HTFL-6B-BRN-500	3/8	10	.251	6	.062	1.6	175	12.1	1,400	96.5	1-1/2	38	.028	.041	500	152
HTFL-8B-BRN-500	1/2	13	.376	10	.062	1.6	155	10.7	950	65.5	2	51	.039	.058	500	152
HTFL-10B-BRN-250	5/8	16	.441	11	.092	2.3	140	9.7	900	62.1	2-7/8	73	.071	.106	250	76
HTFL-12B-BRN-250	3/4	19	.566	14	.092	2.3	150	10.3	800	55.1	3	76	.086	.128	250	76

Construction

Tube: High-temperature and chemical-resistant special polyamide

Reinforcement: High-strength yarn fiber

Cover: High-temperature and UV-resistant special polyamide

Color

● BRN

Operating Parameters

Temperature Range:
-50°F (-46°C) to +266°F (130°C)

Vacuum Rating: 28 inch Hg

Notes

Compatible with JP-5 (MIL-DTL-5624) and JP-8 (MIL-DTL-83133)

Compatible with Biodiesel per Parflex PPB PL-18

Fittings

Parker Fittings available from:
Fluid System Connectors Division
Otsego, MI
(269) 692-6555
(269) 694-4614 FAX

FSC Product Families:

NTA



WARNING

This product can expose you to chemicals including Nickel compounds, which are known to the State of California to cause cancer. For more information go to www.P65Warnings.ca.gov.



HTFL fuel tubing can be formed for easy installation in tight spaces.

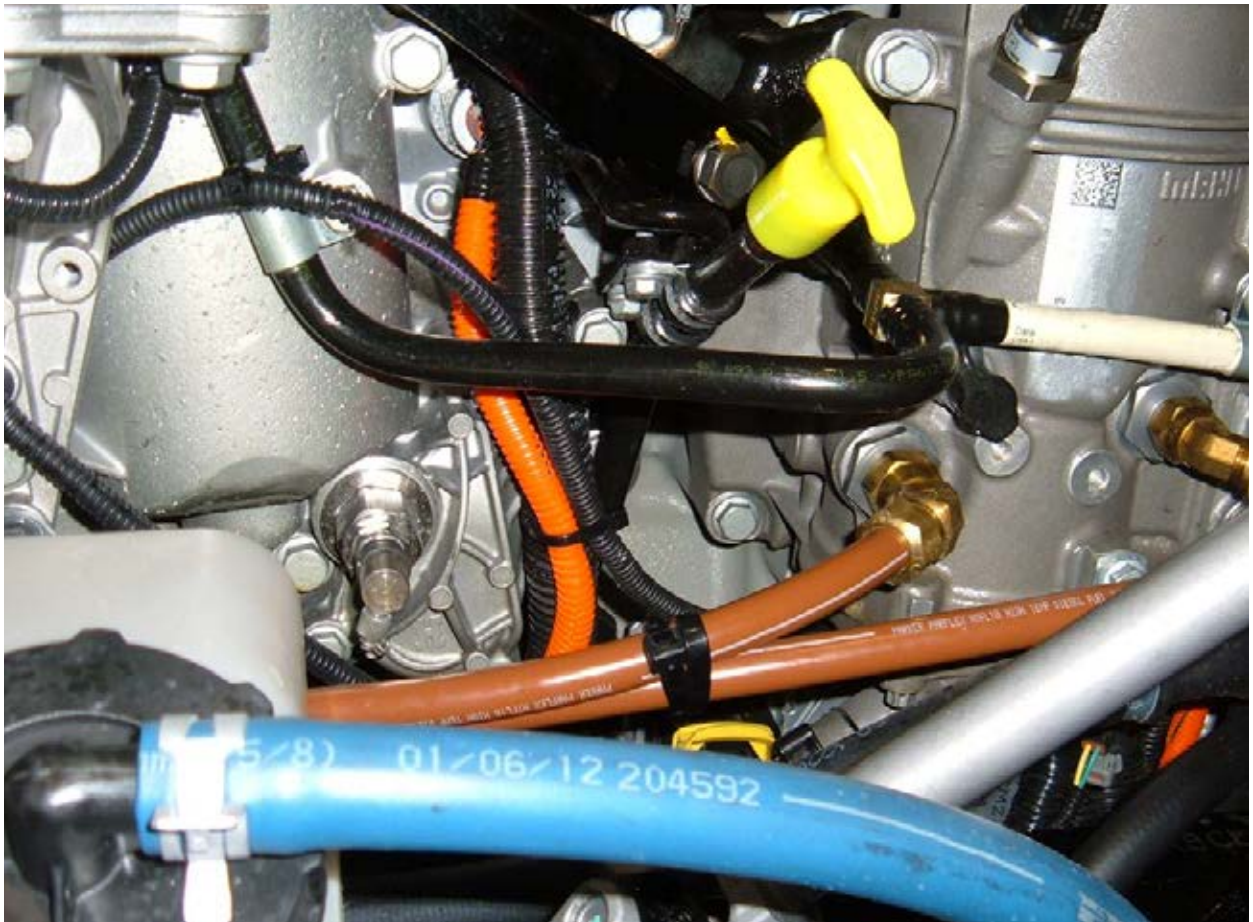

A Hose

B Tubing

C Coiled Air Hose & Fittings

D Transportation

E Fittings

F Tooling, Equipment & Accessories

G General Technical

BrakCoil®



Features

- Tractor-to-trailer coiled nylon air-brake connections
- Maintenance-free performance - designed for trouble-free service on your rig
- Years of city delivery and line haul testing
- Heavy-duty plated spring guards are rust-resistant for added protection
- More coils offer you maximum working lengths
- No need for pogo sticks or spring hangers
- Color coding gives you mistake-free hook-ups – blue for service, red for emergency

Certifications

- Meets or exceeds SAE J844 and D.O.T. FMVSS 106 Specifications at -70°F to +200°F

Applications/Markets



- Tractor to Trailer

Kit Coil Number	Individual Coil Part Number	Tube O.D.		Valve Tail Length		Brass Male Ends (NPT)				Working Length		Number of Coils
		inch	mm	inch	mm	Valve	Gladhand		feet	meter		
#	#	⊙										
731516	731512-RED 731512-BLU	-8	13	12	305	1/2	13	1/2	13	15	4.6	21-1/2
751597	731611-RED 731611-BLU	-8	13	12	305	3/8	10	1/2	13	15	4.6	21-1/2
731522	731513-RED 731513-BLU	-8	13	40	1016	1/2	13	1/2	13	15	4.6	21-1/2
741526	731612-RED 731612-BLU	-8	13	40	1016	3/8	10	1/2	13	15	4.6	21-1/2
751641	741590-RED 741590-BLU	-8	13	6	152	1/2	13	1/2	13	12	3.7	18-1/2
751655	751656-Blk Black Only	-8	13	6	152	3/8	10	1/2	13	12	3.7	18-1/2

Order Information

BRAKCOIL® kits are supplied complete – **Parker pre-assembled**, with everything needed, including spring guards and male pipe NTA brass fittings, **ready to install**. Special pipe thread sealant is factory applied. No cutting or assembly necessary. Just attach the gladhands (sold separately or pre-assembled). They are available in kits or as separate lines. A kit consists of both a red and blue tube assembly.

Construction

Tube: Coiled Nylon Air Brake Tubing

Operating Parameters

Temperature Range:
-70°F (-57°C) to +200°F (93°C)

Options

Extended BRAKCOIL® handle available, part no. 771164

Gladhands available

- BLU - Part # GH9211
- RED - Part # GH9212



WARNING

This product can expose you to chemicals including Lead, which is known to the State of California to cause cancer and birth defects or other reproductive harm. For more information go to www.P65Warnings.ca.gov.

SliderCoil™



Features

- Used between an adjustable rear trailer axle and the final point on a trailer chassis
- No need to install springs or hangers
- Will retract to its original shape even after long periods of extended use

Certifications

- Meets or exceeds SAE J844 and D.O.T. FMVSS 106 Specifications at -70°F to +200°F

Applications/Markets



- Tractor Trailers (Sliding)
- Tractor Trailers (Axles)

Kit Coil Number	Individual Coil Part Number	Tube O.D.		Valve Tail Length		Brass Male Ends (NPT)				Working Length		Number of Coils
						Valve 90° End		Gladhand 180° End				
#	#	⊙										
		inch	mm	inch	mm	inch	mm	inch	mm	feet	meter	
751657	751657-BLU, 751657-RED	-8	13	8	13	1/4	6	1/4	6	9	2.7	13-1/2
751659	751659-BLU, 751659-RED	-8	13	8	13	3/8	10	3/8	10	9	2.7	13-1/2

Order Information

SliderCoil™ kits are supplied complete – **Parker pre-assembled**, with everything needed, including spring guards and male pipe end NTA fittings, **ready to install**. Special pipe thread sealant is factory applied. No cutting or assembly necessary. They are available in kits or as separate lines. A kit consists of both a red and blue coil assemblies.

Construction

Tube: Coiled Nylon Air Brake Tubing

Operating Parameters

Temperature Range:
-70°F (-57°C) to +200°F (93°C)

Color

- Blue
- Red

Options

Extended BRAKCOIL® handle available, part no. 771164



WARNING

This product can expose you to chemicals including Lead, which is known to the State of California to cause cancer and birth defects or other reproductive harm. For more information go to www.P65Warnings.ca.gov.

Fifth Wheel Slider Coil



Features

- Clutter-free hook-up and maintenance-free performance of adjustable length pneumatic tubing for fifth wheel sliding action
- Self-adjusts from 10" to fully extended 74" working length
- Universal, ready for immediate installation
- No maintenance required - stays on the job at peak performance through years of trouble-free life
- Coil set is strong and permanent - Even after prolonged use in fully extended position, coils will retract to shorter length without sagging and eliminating hazards of chafing and wear

Certifications

- Conforms to SAE Specification J844 Type A
- Meets D.O.T. FMVSS 106

Applications/Markets



- Double Trailers
- Convert, Dollies

Part Number	Fittings	Pigtail Length		Maximum Extended Length		Retracted Length	
		inch	mm	inch	mm	inch	mm
#							
811537	(2)68NTA-4-4	2	51	74	1880	10	254
811537-NF-BLK	-	2	51	74	1880	10	254

Order Information

Fifth Wheel Slider Coil part# 811537 comes complete with fittings. Part# 811537-NF-BLK does not include fittings.

Construction

Tube: 1/4" O.D. extruded Nylon, heat and light stabilized, single wall

Operating Parameters

Temperature Range:
-40°F (-40°C) to +200°F (93°C)

Color

- SIL

Options

Available with or without fittings



WARNING

This product can expose you to chemicals including Lead, which is known to the State of California to cause cancer and birth defects or other reproductive harm. For more information go to www.P65Warnings.ca.gov.

Custom Harness, Bundles & Tubing

Order Information

Several different harnesses may be required on a single unit depending upon the model of the vehicle, wheel base and options available. To determine your harness application needs:

- 1. Recognize the cost savings** available to you through the use of harnesses. How many dollars will be saved on tubing installation alone? On scrap reduction?
- 2. Call Parker.** Have one of our application engineers study your application.
- 3. Have Parker engineers design and build a prototype** harness for your approval.
- 4. Approve the prototype** as our basis to engineer your production model harness.
- 5. Implement the harness** into your Purchasing and Production systems – one harness, one part number instead of multiple part numbers you once had for each air brake line.



Cut Tubes

Any tube offered by Parflex can be cut-to-length, with options for additional marking



Formed Tubes

Tubes can be formed into shapes for ease of installation

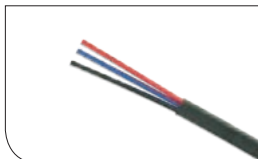

Jacketed Bundles

Two or more tubes can be bundled together with an extruded thermoplastic jacket

Features

- Preformed, pre-bundled tubing or hose custom designed to reduce installation time and improve throughput
- Your production line will run faster and be virtually free from tubing scrap
- Individual tubes are pre-cut and assembled into a single unit

Certifications

- Designed and engineered to meet the exacting requirements of each bus or truck manufacturer for each vehicle
- The air brake tubing used in a Parflex Harness conforms to SAE J844 type 3A and 3B (all sizes) and also D.O.T. FMVSS 49CFR 571, 106 (Except sizes 2A, 3A and 5A)
- Parflex Division is third party certified for ISO 14001 and TS 16949
- 6mm Nylon, 5.5mm EPDM, and 4mm EPDM are IP6X, IPX8, and IPX9K Certified

Tubing

Construction

Tube: Nylon Air Brake Tubing

Operating Parameters

Temperature Range: -40°F (-40°C) to +200°F (93°C)

Working Pressure: 150 psi (10.3 bar)

Options

Each tube can be color-coded and/or numbered

Each harness may contain any number of tube sizes ranging from 1/8" O.D. to 3/4" O.D.

The harness can be supplied with special clamps, brackets and fittings to meet any need required by the customer

Hose

Contact Parflex Customer Service for custom formed hoses and hose assemblies

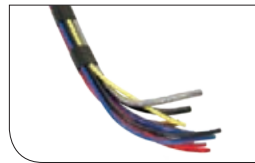

Straight Harnesses

Combine multiple cut tubes into a harness built specifically for your application



Formed Harnesses

Combine multiple formed tubes to create a repeatable tubing routing solution



Formed Assemblies

Most Parflex thermoplastic hoses can be formed into application specific shapes



WARNING

This product can expose you to chemicals including Lead, which is known to the State of California to cause cancer and birth defects or other reproductive harm. For more information go to www.P65Warnings.ca.gov.

SCR Hose Assemblies for Tier IV Compliance



Features

- Thermoplastic and EPDM core tubes reinforced for strength and flexibility
- Stainless steel heating wire
- Extruded thermoplastic jacket
- Heated fittings
- Optional heat/abrasion shield
- 100% electrically tested, pressure tested, and cleaned before shipped

Certifications

- TS 16949
- ISO 14001
- IP6X, IPX8, and IPX9K Certified (4mm EPDM, 5.5mm EPDM, and 6mm Nylon)

Applications/Markets



With Parflex Electrically Heated SCR Hose Assemblies, a cleaner exhaust system means a cleaner environment.

Designed for heating and conveying DEF (Diesel Exhaust Fluid) throughout the SCR system on commercial vehicles. Parflex hoses are made to handle both on-road and off-road applications while helping you stay Tier IV and EPA 10 compliant. Combine these hoses with other high value Parflex fluid conveyance products (pilot lines, grease lines, hydraulic hoses, etc.) and customers can enjoy best in class durability and performance.



Unlike the competition's electrically heated hose, Parflex SCR hoses lock-in the heating elements with an extruded sheath for added protection and long-lasting uniform heating.

U.S. Patent No. 8,819,922
Check www.scrhose.com
for product updates





- Protective Overmolding
 - Protection against water ingress and damage of electrical components
 - Bolsters fitting strength and impact resistance
- Thermoplastic and EPDM core tubes reinforced for strength and flexibility
- Stainless steel heating wire
- Extruded thermoplastic jacket
- Heated fittings
- Optional heat/abrasion shield
- 100% electrically tested, pressure tested, and cleaned before shipped

Core Tube Material	I.D. mm	O.D. mm	With Heat / Abrasion Shield (optional) mm	Maximum Operating Pressure		Minimum Burst Pressure		Vacuum Resistance		Bend Radius mm
				psi	bar	psi	bar	inch	Hg/bar	
EPDM	4	14.5	21	174	12	435	30	14.8	500	30
	5.5	14.5	21	174	12	435	30	14.8	500	40
Nylon	6	14	21	150	10	600	40	8.9	300	40

Operating Parameters

EPDM Temperature Range: -40°F (-40°C) to +248°F (+120°C) with spikes to +266°F (+130°C)

EPDM 5.5 mm Pressure Range: 174 psi. (12 bar) with spikes to 232 psi (16 bar)

Nylon Pressure Line Temperature Range: -40°F (-40°C) to +248°F (+120°C) with spikes to +284°F(+140°C)

Nylon Suction/Throttle Line Temperature Range: -40°F (-40°C) to +158°F (+70°C) with spikes to +221°F(+105°C)

Available in 12VDC, 24VDC, and unheated

Certifications

TS 16949

ISO 14001

IP6X, IPX8, and IPX9K Certified (4mm EPDM, 5.5mm EPDM, and 6mm Nylon)

Notes

EPDM 7.5 mm and 12.3 mm core tubes are available on request in custom configurations.

Standard lengths available in 500 mm increments, ranging from 500 mm (0.5 m) O.A.L. through 6000 mm (6.0 m) in most configurations.



CUSTOM OPTIONS AVAILABLE

SCR options include, but are not limited to:

- different electrical connectors, including options for heat and abrasion shield over lead wires;
- 1/4, 5/16, and 3/8 fittings; wide variety of lengths;
- 12V or 24V

Parflex also has designs for other sizes and core tubes for SCR hoses. These designs ensure that Parflex hoses can be utilized on SCR systems from multiple suppliers.



WARNING

This product can expose you to chemicals including Carbon black extracts, Titanium Dioxide which are known to the State of California to cause cancer and Toluene, which is known to the State of California to cause birth defects or other reproductive harm. For more information go to www.P65Warnings.ca.gov

A Hose

B Tubing

C Coiled Air Hose
& Fittings

D Transportation

F Fittings

M Tooling,
Equipment
& Accessories

G General
Technical

Notes

Permanent/Crimp
Field Attachable



Table of Contents

Introduction

Hose Fitting Nomenclature	E-3
Fitting Configurations by Connection and End Code.....	E-4
Page Series - Sanitary Sizing	E-6

Permanent/Crimp

54 Series	E-10
56 Series	E-13
91N Series	E-34
92 Series	E-43
93N Series	E-44
94/95 Series	E-47
PAGE Fittings	E-48
CG Series	E-56
CY Series	E-62
MS Series	E-65
SF Series	E-67
SQ Series	E-68

Field Attachable/Reuseable

51 Series	E-8
90 Series	E-29
BU Series	E-55
MS Series	E-65

Parflex Fittings

Parker Legacy Fitting Nomenclature

Example: 10356-8-6

This example describes a permanent crimp 1/2" Male JIC 37° with a 3/8" I.D. hose size. This fitting is constructed of steel since the designated material is blank.

- 10356-8-6 – **Fitting Type** (1 = Permanent/Crimp)
(2 = Field Attachable Fitting)
- 10356-8-6 – **End Configuration Code** (Male JIC 37°)
- 10356-8-6 – **Fitting Series** (Series 56)
- 10356-8-6 – **End Size** (1/2")
- 10356-8-6 – **Hose I.D.** (3/8")
- 10356-8-6C – **Alternate Material**

Fitting part numbers that start with a "2" are field attachable fittings

Legacy Fitting Material Selection

- Blank = Steel (unless otherwise noted)
- C = Stainless Steel
- S = Steel – Used only with PTFE Fittings



PAGE Fitting Nomenclature

Example: 08-16SAN-S

This example describes a permanent sanitary flange step down, 1/2" I.D. hose with a 1" sanitary flange. This fitting is constructed of stainless steel since the designated material is -S.

As demonstrated below, the nomenclature associated with the PAGE fitting is not consistent with the traditional Parker products, as the end size and hose I.D. are reversed and located at the front of the part construction.

- 08-16SAN-S – **Hose I.D.** (1/2")
- 08-16SAN-S – **End Size** (1")
- 08-16SAN-S – **End Configuration Code**
(Sanitary Flange)
- 08-16SAN-S – **Alternate Material**

PAGE Fitting Material Selection

- C = Steel
- S = Stainless Steel

NOTE: The PAGE fittings, which are designed for use with traditional PAGE fluoropolymer hoses only, are a two piece crimp connection and need to be combined with the corresponding crimp collars located on page E-48.

A
Hose

B
Tubing

C
Coiled Air Hose
& Fittings

D
Transportation

E
Fittings

F
Tooling,
Equipment
& Accessories

G
General
Technical

Standard Fitting Configurations by Connection and End Code

	Description	End Code
Pipe	Male NPTF Pipe - Rigid - Straight	01
	Male NPTF Pipe - Swivel - Straight	13
	Male NPTF Pipe - Swivel - 90° Elbow	1L
	Female NPTF Pipe - Rigid - Straight	02
	Female NPSM Pipe - Swivel - Straight (60° Cone)	07
SAE Str. Trd.	Male SAE Straight Thread with O-ring - Rigid - Straight	05
	Male SAE Straight Thread with O-ring - Swivel - Straight	0G
	Male SAE Straight Thread with O-ring - Swivel - 90° Elbow	0L
	Male SAE Straight Thread with O-ring - Adjustable - 90° Elbow	35
Flare	Male JIC 37° - Rigid - Straight	03
	Male JIC 37° - Bulkhead without Locknut - Straight	LB
	Female JIC 37° - Swivel - Straight	06
	Female JIC 37° - Swivel - 45° Elbow - Short Drop	37
	Female JIC 37° - Swivel - 45° Elbow - Medium Drop	L7
	Female JIC 37° - Swivel - 90° Elbow - Short Drop	39
	Female JIC 37° - Swivel - 90° Elbow - Medium Drop	L9
	Female JIC 37° - Swivel - 90° Elbow - Long Drop	41
	Male SAE 45° - Rigid - Straight	04
	Female SAE 45° - Swivel - Straight	08
	Female SAE 45 / Swivel - 45° Elbow	77
	Female SAE 45 / Swivel - 90° Elbow	79
	Female SAE 45 / Swivel - 90° Elbow - Long Drop	81
	Female JIC 37°/SAE 45° Dual Flare - Swivel - Straight	06
	Inverted Flare	Male Inverted SAE 45° - Swivel - Straight
Male Inverted SAE 45° - Swivel - 45° Elbow		67
Male Inverted SAE 45° - Swivel - 90° Elbow		69
Female Inverted SAE 45° - Rigid - Straight		29
Seal-Lok	Male Seal-Lok - Rigid - Straight (with O-ring)	J0
	Male Seal-Lok - Bulkhead without Locknut-Straight (with O-ring)	JB
	Female Seal-Lok - Swivel - Straight - Long	JS
	Female Seal-Lok - Swivel - Straight - Short	JC
	Female Seal-Lok - Swivel - 30° Elbow	J2
	Female Seal-Lok - Swivel - 22 1/2° Elbow	J6
	Female Seal-Lok - Swivel - 45° Elbow	J7
	Female Seal-Lok - Swivel - 90° Elbow - Short Drop	J9
	Female Seal-Lok - Swivel - 90° Elbow - Medium Drop	J5
	Female Seal-Lok - Swivel - 90° Elbow - Long Drop	J1
JIS	Female Metric Swivel - Straight (30° Flare)	MU
	Female BSP Parallel Pipe - Swivel - Straight (30° Flare)	FU
	Male BSP Taper Pipe - Rigid - Straight (60° Cone)	UT
	Female BSP Parallel Pipe - Swivel - Straight (60° Cone)	GU
	Female BSP Parallel Pipe - Swivel - 45° Elbow (60° Cone)	G1
Metric	Female BSP Parallel Pipe - Swivel - 90° Elbow (60° Cone)	G2
	Male Metric L - Rigid - Straight (24° Cone)	D0
	Male Standpipe Metric L - Rigid - Straight	1D

Standard Fitting Configurations by Connection and End Code

	Description	End Code
Metric	Female Metric L - Swivel - Straight (Ball Nose)	C3
	Female Metric L - Swivel - 45° Elbow (Ball Nose)	C4
	Female Metric L - Swivel - 90° Elbow (Ball Nose)	C5
	Female Metric L - Swivel - Straight (24° Cone with O-ring)	CA
	Female Metric L - Swivel - 45° Elbow (24° Cone with O-ring)	CE
	Female Metric L - Swivel - 90° Elbow (24° Cone with O-ring) -	CF
	Male Metric S - Rigid - Straight (24° Cone)	D2
	Male Standpipe Metric S - Rigid - Straight	3D
	Female Metric S - Swivel - Straight (Ball Nose)	C6
	Female Metric S - Swivel - 45° Elbow (Ball Nose)	C7
	Female Metric S - Swivel - 90° Elbow (Ball Nose)	C8
	Female Metric S - Swivel - Straight (24° Cone with O-ring)	C9
	Female Metric S - Swivel - 45° Elbow (24° Cone with O-ring)	0C
	Female Metric S - Swivel - 90° Elbow (24° Cone with O-ring)	1C
	BSP	Male BSP Taper Pipe - Rigid - Straight
Female BSP Parallel Pipe - Swivel - Straight (60° Cone)		92
Male BSP Parallel Pipe - Rigid - Straight (60° Cone)		D9
Female BSP Parallel Pipe - Swivel - 45° Elbow (60° Cone)		B1
Female BSP Parallel Pipe - Swivel - 90° Elbow (60° Cone)		B2
Female BSP Parallel Pipe - Swivel - 90° Elbow Block Type (60° Cone)		B4
Female BSP Parallel Pipe - Swivel - Straight (Flat Seat)		B5
Male BSP Taper Pipe - Rigid - 45° Elbow		BV
Male BSP Taper Pipe - Rigid - 90° Elbow or Side Outlet		BZ
Fr. Gaz	Male French Gaz Series - Rigid - Straight (24° Cone)	FG
	Female French Gaz Series - Swivel - Straight (Ball Nose)	F4
Specialty	Male Ferulok Flareless Rigid-Straight (24° Cone with Nut & Ferrule)	11
	Female Ferulok Flareless - Swivel - Straight (24° Cone)	12
	DIN Metric Banjo - Straight	49
	ANSI B16.5 Flange	4K
	Female A-Lok® Compression	AL
	Female Cam & Groove	FC
	Sanitary Flange & Step Downs	FN
	Mini Sanitary Flange	FV
	Bulkhead w/Zerk Port Integrated	GK
	Male I-Line® Sanitary	H1
	Female I-Line® Sanitary	H2
	Male Sanitary Bevel Seat	H4
	Female Sanitary Bevel Seat	H5
	Male Standpipe - Rigid - Straight (Inch Size Tube O.D.)	34
	Male Standpipe - Rigid - Straight with V-Notch	TW
	Universal Tube Stub	TU
	Male Rapid Assembly, Straight	WU
	Male Rapid Assembly, 45° Elbow	WW
	Male Rapid Assembly, 90° Elbow	WY

A
Hose

B
Tubing

C
Coiled Air Hose
& Fittings

D
Transportation

E
Fittings

F
Tooling,
Equipment
& Accessories

G
General
Technical

PAGE Series - Sanitary Sizing

Typical Dimensions

These actual size drawings are provided to eliminate sizing errors when specifying sanitary fittings. The outside diameter is the same for 1/8", 1/4", 3/8", 1/2" and the 3/4" (mini) styles. For your convenience and ordering accuracy, all of these drawings may be used as sizing I.D. and O.D. patterns. These fittings are ASME-BPE compliant.

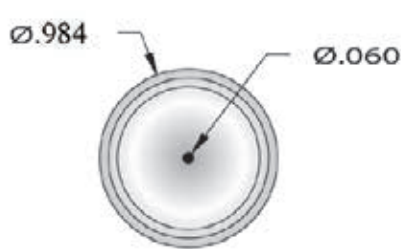

1/8" MINI T.C.

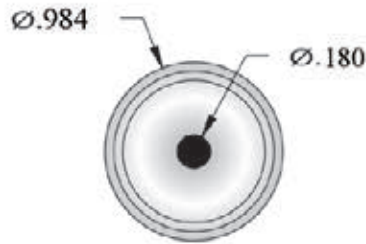

1/4" MINI T.C.

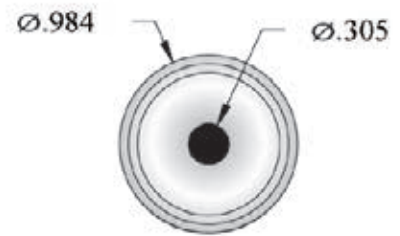

3/8" MINI T.C.

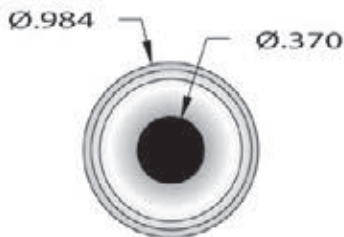

1/2" MINI T.C.

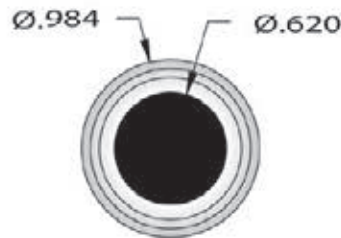

3/4" MINI T.C.

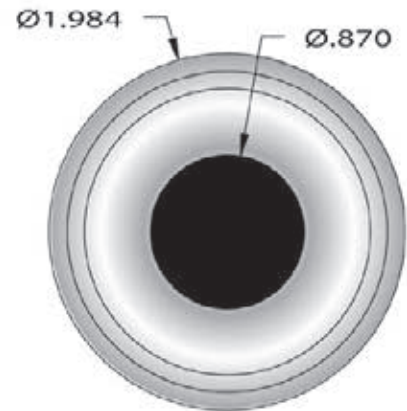

1" T.C.

PAGE Series - Sanitary Sizing

Typical Dimensions

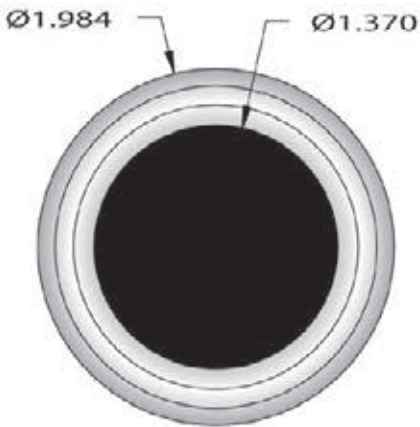

1 1/2" T.C.

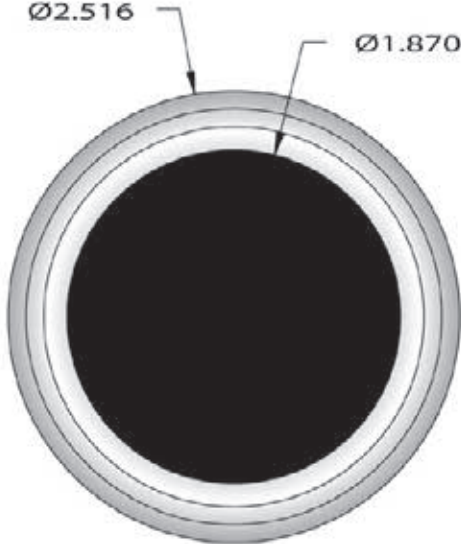

2" T.C.

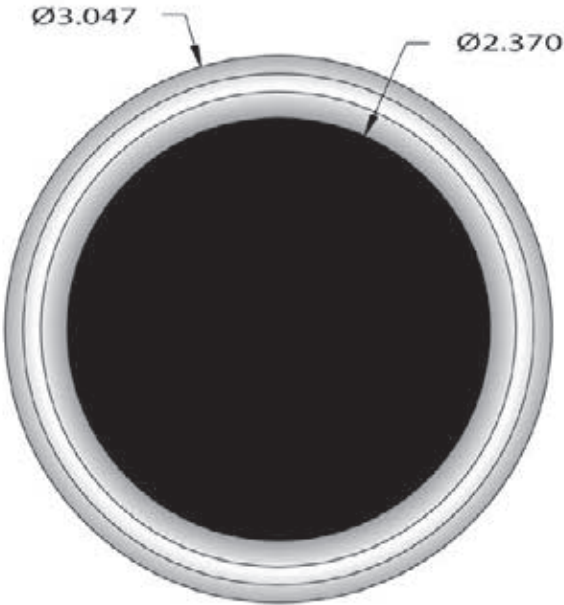

2 1/2" T.C.

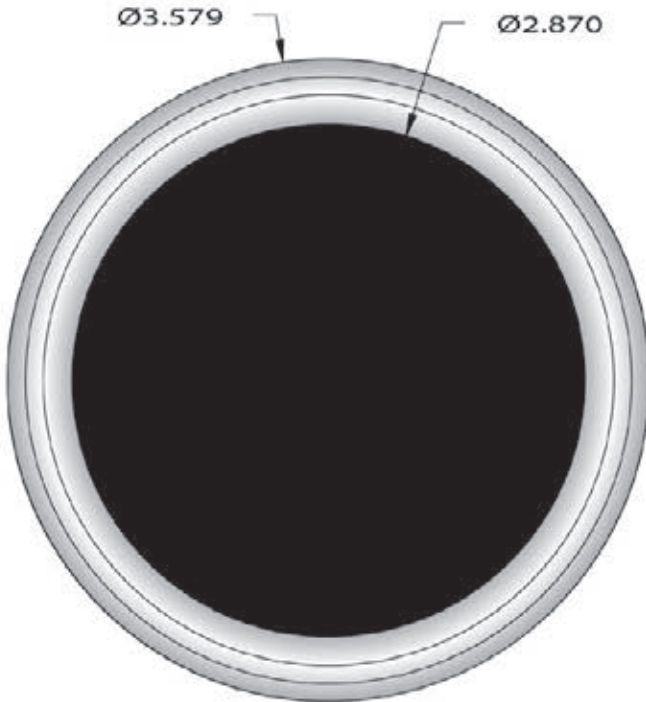

3" T.C.

A
Hose

B
Tubing

C
Coiled Air Hose
& Fittings

D
Transportation

E
Fittings

F
Tooling,
Equipment
& Accessories

G
General
Technical



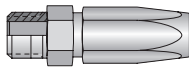
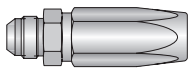
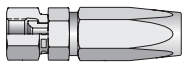
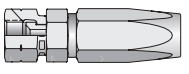
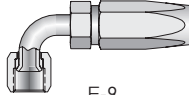

51 Series Visual Index

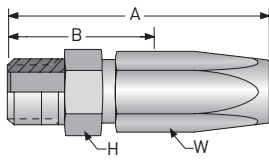
51 Series FIELD ATTACHABLE	201 Male Taper Pipe Rigid	203 Male (JIC) 37°	206 SAE (JIC) 37° Swivel	208 SAE 45° Swivel	239 (JIC) 37° Swivel 90° Elbow Short
	 E-8	 E-8	 E-9	 E-9	 E-9

20151 Male Taper Pipe Rigid





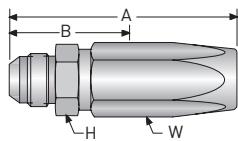

Construction: Steel. Add "C" for Stainless Steel.

Part Number	Thread Size	Hose I.D.		A		Cutoff Allow. B		H Hex	W Hex
		inch	mm	inch	mm	inch	mm	inch	inch
#									
20151-2-3	1/8-27	3/16	5	1.71	43	1	25	7/16	5/8
20151-4-3	1/4-18	3/16	5	1.90	48	1-1/8	29	9/16	5/8
20151-2-4	1/8-27	1/4	6	1.90	48	1	25	1/2	5/8
20151-4-4	1/4-18	1/4	6	2.08	53	1-3/16	30	9/16	5/8
20151-4-5	1/4-18	5/16	8	2.17	55	1-7/16	37	9/16	3/4
20151-6-5	3/8-18	5/16	8	2.17	55	1-7/16	37	3/4	3/4
20151-4-6	1/4-18	3/8	10	2.61	66	1-7/16	37	3/4	7/8
20151-6-6	3/8-18	3/8	10	2.61	66	1-7/16	37	3/4	7/8
20151-8-6	1/2-14	3/8	10	2.80	71	1-9/16	40	7/8	7/8
20151-6-8	3/8-18	1/2	13	2.99	76	1-1/2	38	7/8	1-1/16
20151-8-8	1/2-14	1/2	13	3.17	81	1-11/16	43	7/8	1-1/16
20151-12-12	3/4-14	3/4	19	3.42	87	1-3/4	44	1-1/8	1-3/8
20151-16-16	1-11-1/2	1	25	3.74	95	2-1/4	57	1-3/8	1-9/16

20351 Male (JIC) 37° Rigid



Construction: Steel. Add "C" for Stainless Steel.

Part Number	Thread Size	Hose I.D.		A		Cutoff Allow. B		H Hex	W Hex
		inch	mm	inch	mm	inch	mm	inch	inch
#									
20351-4-3	7/16-20	3/16	5	1.88	48	1-1/8	29	1/2	5/8
20351-5-4	1/2-20	1/4	6	2.06	52	1-1/8	29	9/16	5/8
20351-6-5	9/16-18	5/16	8	2.16	55	1-5/16	33	5/8	3/4
20351-6-6	9/16-18	3/8	10	2.61	66	1-7/16	37	3/4	7/8
20351-8-6	3/4-16	3/8	10	2.71	69	1-7/16	37	13/16	7/8
20351-8-8	3/4-16	1/2	13	3.08	78	1-5/8	41	7/8	1-1/16

51 series field attachable couplings are not intended for use on hose that has previously been in service.



WARNING

This product can expose you to chemicals including Lead, which is known to the State of California to cause cancer and birth defects or other reproductive harm. For more information go to www.P65Warnings.ca.gov.

20651 SAE (JIC) 37° Swivel

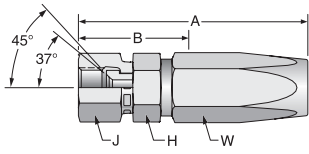

Construction: Steel. Add "C" for Stainless Steel.

Part Number	Thread Size	Hose I.D.		A		Cutoff Allow. B		H Hex	J Hex	W Hex
		inch	mm	inch	mm	inch	mm	inch	inch	inch
#										
20651-4-3	7/16-20	3/16	5	1.99	51	1-1/4	32	9/16	9/16	5/8
20651-4-4	7/16-20	1/4	6	2.18	55	1-1/4	32	9/16	9/16	5/8
20651-5-4	1/2-20	1/4	6	2.24	57	1-7/16	37	5/8	5/8	5/8
20651-6-4	9/16-18	1/4	6	2.34	59	1-7/16	37	11/16	11/16	5/8
20651-6-5	9/16-18	5/16	8	2.37	60	1-1/2	38	11/16	11/16	3/4
20651-6-6	9/16-18	3/8	10	2.74	70	1-7/16	37	11/16	11/16	7/8
20651-8-6	3/4-16	3/8	10	2.88	73	1-5/8	41	7/8	7/8	7/8
20651-8-8	3/4-16	1/2	13	3.25	83	1-3/4	44	7/8	7/8	1-1/16
20651-10-8	7/8-14	1/2	13	3.37	86	1-7/8	48	1	1	1-1/16
20651-12-12	1-1/16-12	3/4	19	3.75	95	2-1/8	54	1-1/4	1-1/4	1-3/8
20651-16-16	1-5/16-12	1	25	3.87	98	2-1/4	57	1-1/2	1-1/2	1-9/16

20851 SAE 45° Swivel

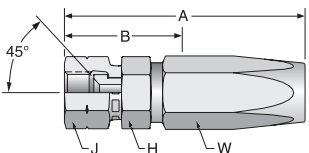

Construction: Steel. Add "C" for Stainless Steel.

Part Number	Thread Size	Hose I.D.		A		Cutoff Allow. B		H Hex	J Hex	W Hex
		inch	mm	inch	mm	inch	mm	inch	inch	inch
#										
20851-6-6	5/8-18	3/8	10	2.82	72	1-9/16	40	3/4	3/4	7/8

23951 JIC 37° Swivel 90° Elbow Short Drop

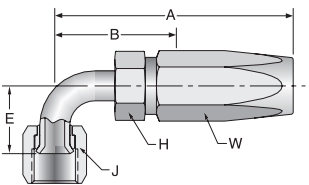

Construction: Steel. Add "C" for Stainless Steel.

Part Number	Thread Size	Hose I.D.		A		Cutoff Allow. B		E		H Hex	J Hex	W Hex
		inch	mm	inch	mm	inch	mm	inch	mm	inch	inch	inch
#												
23951-4-3	7/16-20	3/16	5	1.77	45	1	25	0.83	21	3/8	9/16	5/8
23951-6-6	9/16-18	3/8	10	2.70	69	1-7/16	37	0.85	22	9/16	11/16	7/8
23951-8-6	3/4-16	3/8	10	2.90	74	1-5/8	41	1.09	28	11/16	7/8	7/8

51 series field attachable couplings are not intended for use on hose that has previously been in service.



WARNING

This product can expose you to chemicals including Lead, which is known to the State of California to cause cancer and birth defects or other reproductive harm. For more information go to www.P65Warnings.ca.gov.

A Hose

B Tubing

C Coiled Air Hose & Fittings

D Transportation

E Fittings

F Tooling, Equipment & Accessories

G General Technical

54 Series Visual Index

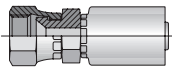
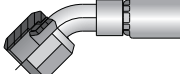
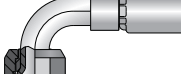
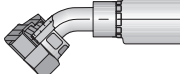
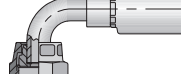
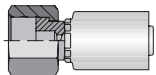
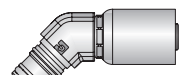
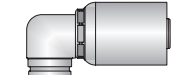
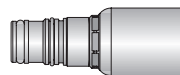

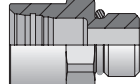
54 Series PERMANENT	106 Female SAE (JIC) 37° Swivel	137 Female (JIC) 37° Swl, 45° Elbow	139 Female (JIC) 37° Swl, 90° Elbow	1J7 Female Seal-Lok™ 45° Elbow	1J9 Female Seal-Lok™ 90° Elbow Short
	 E-11	 E-11	 E-11	 E-10	 E-11
	1JC Female Seal-Lok™ Str. Short O-ring	1WW Male Rapid Assembly, 45° Elb.	1WY Male Rapid Assembly, 90° Elb.	1WU Male Rapid Assembly, Straight	
	 E-10	 E-12	 E-12	 E-12	

54 Series Adapter PERMANENT	685RA Female Rapid Assy. Adapter Male SAE
	 E-12

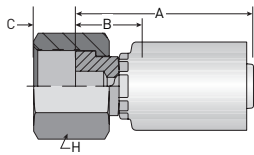
1JC54 Female Seal-Lok™ Straight Short O-ring Face Seal ISO 12151-1 SWSA





Construction: Steel.

Part Number	Thread Size	Hose I.D.		A		Cutoff Allow. B		C		H Hex
		inch	mm	inch	mm	inch	mm	inch	mm	inch
#										
1JC54-4-4	9/16-18	1/4	6	1.38	35	5/8	16	.32	8	11/16
1JC54-6-6	11/16-16	3/8	10	1.58	40	9/16	14	.32	8	13/16

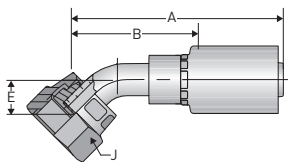
1J754 Female Seal-Lok™ 45° Elbow O-ring Face Seal ISO 12151-1 SWE45



Construction: Steel.

Part Number	Thread Size	Hose I.D.		A		Cutoff Allow. B		E		J Hex
		inch	mm	inch	mm	inch	mm	inch	mm	inch
#										
1J754-4-4	9/16-18	1/4	6	2.16	55	1-3/8	35	0.41	10	11/16

WARNING This product can expose you to chemicals including Lead, which is known to the State of California to cause cancer and birth defects or other reproductive harm. For more information go to www.P65Warnings.ca.gov.

1J954 Female Seal-Lok™ 90° Elbow O-ring Face Seal Short Drop ISO 12151-1 SWES90

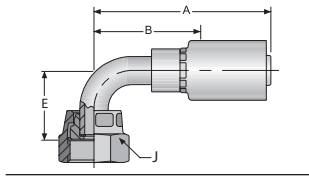

Construction: Steel.

Part Number	Thread Size	Hose I.D.		A		Cutoff Allow. B		E		J Hex
		inch	mm	inch	mm	inch	mm	inch	mm	inch
#										
1J954-4-4	9/16-18	1/4	6	2.14	54	1-3/8	35	0.83	21	11/16
1J954-6-6	11/16-16	3/8	10	2.32	59	1-3/8	35	0.90	23	13/16

10654 Female SAE (JIC) 37° Swivel

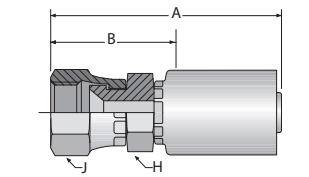

Construction: Steel.

Part Number	Thread Size	Hose I.D.		A		Cutoff Allow. B		H Hex	J Hex
		inch	mm	inch	mm	inch	mm	inch	inch
#									
10654-4-4	7/16-20	1/4	6	1.75	45	1	25	9/16	9/16
10654-6-6	9/16-18	3/8	10	2.13	54	1-3/16	30	11/16	11/16

NOTE: Sizes -4 incorporates a dual seat.

13754 Female JIC 37° Swivel 45° Elbow Short Drop

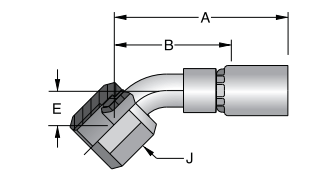

Construction: Steel.

Part Number	Thread Size	Hose I.D.		A		Cutoff Allow. B		E		J Hex
		inch	mm	inch	mm	inch	mm	inch	mm	inch
#										
13754-4-4	7/16-20	1/4	6	2.08	53	1-1/4	32	.33	8	9/16

13954 Female JIC 37° Swivel 90° Elbow Short Drop

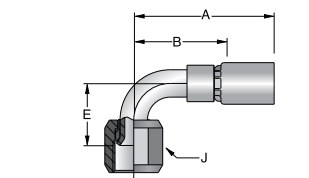

Construction: Steel.

Part Number	Thread Size	Hose I.D.		A		Cutoff Allow. B		E		J Hex
		inch	mm	inch	mm	inch	mm	inch	mm	inch
#										
13954-4-4	7/16-20	1/4	6	1.97	50	1-3/16	30	.68	17	9/16
13954-6-6	9/16-18	3/8	10	2.30	59	1-5/8	41	.85	22	11/16



WARNING

This product can expose you to chemicals including Lead, which is known to the State of California to cause cancer and birth defects or other reproductive harm. For more information go to www.P65Warnings.ca.gov.

A Hose

B Tubing

C Coiled Air Hose & Fittings

D Transportation

E Fittings

F Tooling, Equipment & Accessories

G General Technical

1WW54 Male Rapid Assembly 45° Elbow

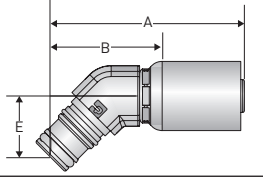

Construction: Steel, Nitrile O-ring.

Part Number	Stem O.D.		Hose I.D.		A		Cutoff Allow. B		E	
	inch	mm	inch	mm	inch	mm	inch	mm	inch	mm
#										
1WW54-4-4	1/4	6	1/4	6	1.97	50	1-3/16	30	.67	17
1WW54-6-6	3/8	10	3/8	10	2.19	56	1-3/16	30	.69	18

NOTE: Use with mating adapter PN 685RA.

1WY54 Male Rapid Assembly 90° Elbow

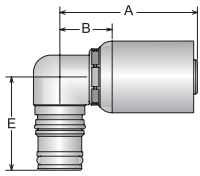

Construction: Steel, Nitrile O-ring.

Part Number	Stem O.D.		Hose I.D.		A		Cutoff Allow. B		E	
	inch	mm	inch	mm	inch	mm	inch	mm	inch	mm
#										
1WY54-4-4	1/4	6	1/4	6	1.27	32	1/2	13	.90	23
1WY54-6-6	3/8	10	3/8	10	1.49	38	1/2	13	1.00	25

NOTE: Use with mating adapter PN 685RA.

1WU54 Male Rapid Assembly Straight

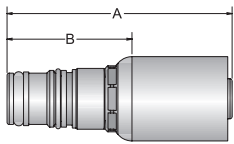

Construction: Steel, Nitrile O-ring.

Part Number	Stem O.D.		Hose I.D.		A		Cutoff Allow. B	
	inch	mm	inch	mm	inch	mm	inch	mm
#								
1WU54-4-4	1/4	6	1/4	6	1.85	47	1-1/16	27
1WU54-6-6	3/8	10	3/8	10	2.13	54	1-1/8	29

NOTE: Use with mating adapter PN 685RA.

685RA Adapter Female Rapid Assembly - Male SAE Straight Thread ORB

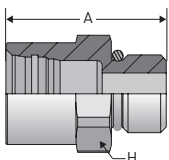

Construction: Steel, Nitrile O-ring.

Part Number	Stem O.D.		Thread Size	A		H Hex
	inch	mm		inch	mm	inch
#						
685RA-4-4	1/4	6	7/16-20	1.05	27	11/16
685RA-6-4	3/8	10	7/16-20	1.15	29	3/4
685RA-4-6	1/4	6	9/16-18	1.12	28	3/4
685RA-6-6	3/8	10	9/16-18	1.15	29	3/4









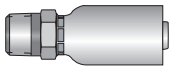
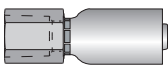
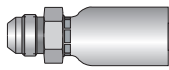
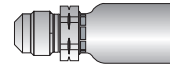
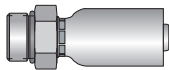
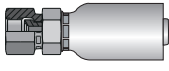
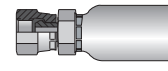
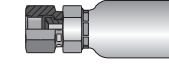

NOTE: Use with mating fittings 1WU54, 1WW54, 1WY54.

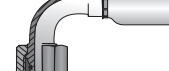
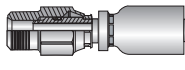
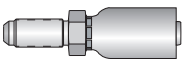
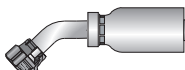
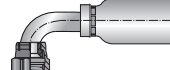

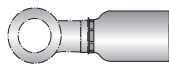
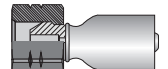
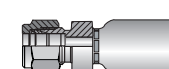
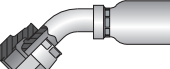
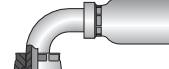
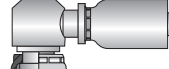
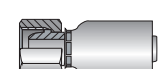
WARNING

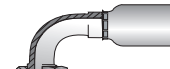
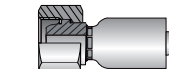
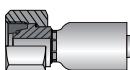
This product can expose you to chemicals including Lead, which is known to the State of California to cause cancer and birth defects or other reproductive harm. For more information go to www.P65Warnings.ca.gov.

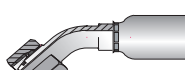
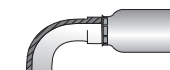
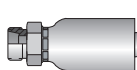
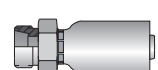
56 Series Visual Index

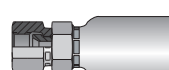
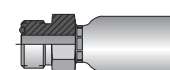
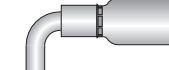
56 Series PERMANENT	101 Male Taper Pipe Rigid	102 Female Taper Pipe Rigid	103 Male (JIC) 37° Rigid	104 Male SAE 45° Rigid	105 Male Str. Thread O-ring
					
	E-14	E-14	E-15	E-15	E-15
	106 SAE (JIC) 37° Swivel	107 Female Pipe Swivel	108 Female SAE 45° Swivel	10C M FM Swivel 24° O-ring 45° Elb. Lt.	11C M FM Swivel 24° O-ring 90° Elb. Lt.
					
	E-16	E-16	E-17	E-23	E-23
	113 Male Pipe Swivel	13E Male (JIC) 37° Long	137 FM JIC 37° Swivel 45° Elbow	139 FM JIC 37° Swivel 90° Elbow	141 Female JIC 37° Swivel 90° Elbow-Lg
					
	E-17	E-17	E-18	E-18	E-19
	149 Banjo Union	192 FM BSP Parallel Pipe Swivel Str.	1AL A-Lok Compression	1B1 Female BSP Pipe Swivel 45° Elb. (60° Cone)	1B2 Female BSP Pipe Swivel 90° Elb. (60° Cone)
					
E-19	E-23	E-24	E-24	E-24	
1B4 FM BSP Swivel 90° Elb. Block Type (60° Cone)	1C3 M FM Swivel Nut Light	1C4 M FM Swivel 45° Elbow Lt.	1C5 M FM Swivel 90° Elbow Lt.	1C6 M FM Swivel DIN 20078 HW w/o O-ring	
					
E-24	E-25	E-25	E-25	E-26	
1C9 M FM Swivel DIN 20078 HW O-ring	1CA M FM Swivel 24° Lt. O-ring	1CE M FM Swivel 24° O-ring 45° Elb.	1CF M FM Swivel 24° O-ring 90° Elb.	1D0 M Male Stud DIN 20078 Lt.	
					
E-26	E-26	E-27	E-27	E-28	
1D2 M Male Stud 24° Heavy	1D9 Male BSPP - Str. (60° Cone)	1FU JIS/BSP 30° Flare Swivel Female	1J0 Male Seal-Lok™ Rigid Str. w/O-ring	1J1 Female Seal-Lok™ 90° Elbow Long	
					
E-28	E-28	E-27	E-20	E-20	



WARNING

This product can expose you to chemicals including Lead, which is known to the State of California to cause cancer and birth defects or other reproductive harm. For more information go to www.P65Warnings.ca.gov.

A Hose

B Tubing

C Coiled Air Hose & Fittings

D Transportation

E Fittings

F Tooling, Equipment & Accessories

G General Technical

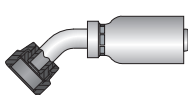
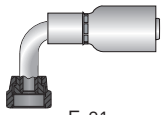
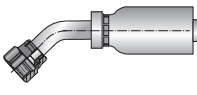
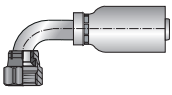
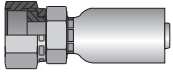
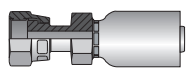
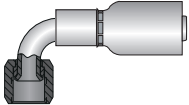
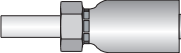

56 Series Permanent

A Hose	56 Series PERMANENT	1J2 Female Seal-Lok™ 30° Elbow	1J5 Female Seal-Lok™ Swivel 90° Elb. Med.	1J7 Female Seal-Lok™ Swivel 45° Elbow	1J9 Female Seal-Lok™ Swivel 90° Elb. Short	1JC Female Seal-Lok™ Str. Swivel Short
		 E-21	 E-21	 E-22	 E-22	 E-20
B Tubing	1JS Female Seal-Lok™ Straight	1L9 Female JIC 37° Swivel 90° Elb. Med.	1TU Universal Inch Tube Stub End			
	 E-21	 E-19	 E-22			

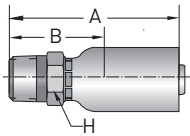
10156 Male Taper Pipe Rigid





Construction: Steel. Add "C" for Stainless Steel.

Part Number	Thread Size	Hose I.D.		A		Cutoff Allow. B		H Hex
		inch	mm	inch	mm	inch	mm	inch
#								
10156-2-2	1/8-27	1/8	3	1.35	34	3/4	19	1/2
10156-2-3	1/8-27	3/16	5	1.60	41	7/8	22	9/16
10156-4-2	1/4-18	1/8	3	1.56	40	15/16	24	5/8
10156-4-3	1/4-18	3/16	5	1.82	46	1-1/8	28	9/16
10156-4-4	1/4-18	1/4	6	2.09	53	1-1/8	28	9/16
10156-4-6	1/4-18	3/8	10	2.16	55	1-3/16	30	11/16
10156-6-6	3/8-18	3/8	10	2.16	55	1-3/16	30	3/4
10156-8-8	1/2-14	1/2	13	2.55	65	1-7/16	37	7/8
10156-12-10	3/4-14	5/8	16	2.88	73	1-9/16	40	1-1/8
10156-12-12	3/4-14	3/4	19	2.97	75	1-5/8	41	1-1/16
10156-16-16	1-11-1/2	1	25	3.76	96	1-7/8	48	1-3/8

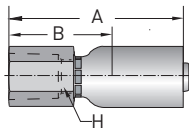
10256 Female Taper Pipe Rigid



Construction: Steel. Add "C" for Stainless Steel.

Part Number	Thread Size	Hose I.D.		A		Cutoff Allow. B		H Hex
		inch	mm	inch	mm	inch	mm	inch
#								
10256-4-4	1/4-18	1/4	6	1.99	51	1	25	11/16

WARNING This product can expose you to chemicals including Lead, which is known to the State of California to cause cancer and birth defects or other reproductive harm. For more information go to www.P65Warnings.ca.gov.

10356 Male (JIC) 37° Rigid

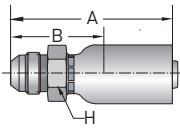

Construction: Steel. Add "C" for Stainless Steel.

Part Number	Thread Size	Hose I.D.		A		Cutoff Allow. B		H Hex
		inch	mm	inch	mm	inch	mm	inch
#								
10356-4-3	7/16-20	3/16	5	1.83	46	1-1/8	28	9/16
10356-4-4	7/16-20	1/4	6	2.10	53	1-1/8	28	9/16
10356-5-4	1/2-20	1/4	6	2.10	53	1-1/8	28	9/16
10356-6-4	9/16-18	1/4	6	2.14	54	1-3/16	30	11/16
10356-6-5	9/16-18	5/16	8	2.22	56	1-3/16	30	11/16
10356-5-6	1/2-20	3/8	10	2.14	54	1-1/8	28	5/8
10356-6-6	9/16-18	3/8	10	2.15	55	1-3/16	30	5/8
10356-8-6	3/4-16	3/8	10	2.25	57	1-1/4	32	13/16
10356-8-8	3/4-16	1/2	13	2.40	61	1-5/16	33	7/8
10356-10-8	7/8-14	1/2	13	2.60	66	1-1/2	38	15/16
10356-12-10	1-1/16-12	5/8	16	2.97	75	1-5/8	42	1-1/8
10356-12-12	1-1/16-12	3/4	19	3.07	78	1-3/4	44	1-1/8
10356-16-16	1-5/16-12	1	25	3.66	93	1-3/4	44	1-3/8

10456 Male SAE 45° Rigid

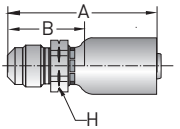

Construction: Steel. Add "C" for Stainless Steel.

Part Number	Thread Size	Hose I.D.		A		Cutoff Allow. B		H Hex
		inch	mm	inch	mm	inch	mm	inch
#								
10456-4-3	7/16-20	3/16	5	1.71	43	1	25	9/16
10456-5-4	1/2-20	1/4	6	2.11	54	1-1/8	28	9/16
10456-6-5	5/8-18	5/16	8	2.18	55	1-3/16	30	11/16
10456-6-6	5/8-18	1/2	13	2.16	55	1-3/16	30	11/16
10456-6-8	5/8-18	1/2	13	2.37	60	1-1/4	32	3/4
10456-8-8	3/4-16	1/2	13	0.25	64	1-3/8	35	7/8
10456-12-12	1-1/16-14	3/4	19	3.11	79	1-3/4	44	1-1/8

10556 Male Straight Thread O-ring (Nitrile O-ring included)

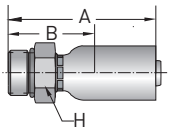

Construction: Steel. Add "C" for Stainless Steel.

Part Number	Thread Size	Hose I.D.		A		Cutoff Allow. B		H Hex
		inch	mm	inch	mm	inch	mm	inch
#								
10556-4-3	7/16-20	3/16	4	1.61	41	15/16	24	9/16
10556-6-3	9/16-18	3/16	4	1.64	42	15/16	24	11/16
10556-4-4	7/16-20	1/4	6	1.84	47	7/8	22	9/16
10556-5-4	1/2-20	1/4	6	1.84	47	7/8	22	5/8
10556-6-4	9/16-18	1/4	6	1.91	49	15/16	24	11/16
10556-4-5	7/16-20	5/16	8	1.91	49	7/8	22	5/8
10556-5-5	1/2-20	5/16	8	1.91	49	7/8	22	5/8
10556-6-6	9/16-18	3/8	10	1.95	50	15/16	24	11/16
10556-8-6	3/4-16	3/8	10	1.98	50	1	25	7/8
10556-8-8	3/4-16	1/2	12	2.21	56	1-1/8	28	7/8
10556-10-8	7/8-14	1/2	12	2.28	58	1-3/16	30	1



WARNING

This product can expose you to chemicals including Lead, which is known to the State of California to cause cancer and birth defects or other reproductive harm. For more information go to www.P65Warnings.ca.gov.

A Hose

B Tubing

C Coiled Air Hose & Fittings

D Transportation

E Fittings

F Tooling, Equipment & Accessories

G General Technical

A Hose

10656 SAE (JIC) 37° Swivel

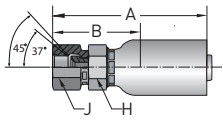

Construction: Steel. Add "C" for Stainless Steel.

B Tubing

C Coiled Air Hose & Fittings

D Transportation

F Fittings

F Tooling, Equipment & Accessories

G General Technical

Part Number	Thread Size	Hose I.D.		A		Cutoff Allow. B		H Hex	J Hex
		inch	mm	inch	mm	inch	mm	inch	inch
#									
10656-2-2	5/16-24	1/8	3	1.63	41	1	25	1/2	1/2
10656-3-2	3/8-24	1/8	3	1.60	41	1	25	1/2	9/16
10656-4-2	7/16-20	1/8	3	1.68	43	1	25	1/2	5/8
10656-3-3	3/8-24	3/16	5	1.91	49	1-3/16	30	1/2	1/2
10656-4-3	7/16-20	3/16	5	1.78	45	1-1/16	27	9/16	9/16
10656-5-3	1/2-20	3/16	5	1.84	47	1-1/8	28	9/16	5/8
10656-2-4	3/8-24	1/4	6	1.98	50	1	25	1/2	7/16
10656-4-4	7/16-20	1/4	6	2.05	52	1-1/16	27	9/16	9/16
10656-5-4	1/2-20	1/4	6	2.12	54	1-1/8	28	9/16	5/8
10656-6-4	9/16-18	1/4	6	2.14	54	1-3/16	30	11/16	9/16
10656-4-5	7/16-20	5/16	8	2.10	53	1-1/16	27	9/16	9/16
10656-5-5	1/2-20	5/16	8	2.21	56	1-3/16	30	5/8	5/8
10656-6-5	9/16-18	5/16	8	2.23	57	1-3/16	30	5/8	11/16
10656-4-6	7/16-20	3/8	10	2.09	53	1-1/8	28	9/16	9/16
10656-5-6	1/2-20	3/8	10	2.23	57	1-1/4	32	5/8	5/8
10656-6-6	9/16-18	3/8	10	2.22	56	1-1/4	32	11/16	11/16
10656-8-6	3/4-16	3/8	10	2.37	60	1-3/8	35	11/16	7/8
10656-6-8	9/16-18	1/2	13	2.42	61	1-5/16	33	3/4	11/16
10656-8-8	3/4-16	1/2	13	2.54	64	1-7/16	36	13/16	7/8
10656-10-8	7/8-14	1/2	13	2.64	67	1-1/2	38	7/8	1
10656-8-10	3/4-16	5/8	16	2.73	69	1-7/16	36	15/16	7/8
10656-10-10	7/8-14	5/8	16	2.99	76	1-11/16	43	15/16	1
10656-12-10	1-1/16-12	5/8	16	3.06	78	1-3/4	44	1-1/16	1-1/4
10656-10-12	7/8-14	3/4	19	2.88	73	1-1/2	38	1-1/16	1
10656-12-12	1-1/16-12	3/4	19	3.06	78	1-3/4	44	1-1/16	1-1/4
10656-16-12	1-5/16-12	3/4	19	3.27	83	1-15/16	49	1-1/4	1-1/2
10656-16-16	1-5/16-12	1	25	3.81	97	1-15/16	49	1-3/8	1-1/2
10656-20-16	1-5/8-12	1	25	3.96	101	2-1/16	52	1-5/8	2

Sizes -4, -5, -8 and -10 incorporate a dual seat.

10756 Female Pipe Swivel

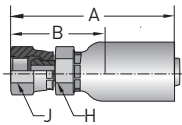

Construction: Steel. Add "C" for Stainless Steel.

Part Number	Thread Size	Hose I.D.		A		Cutoff Allow. B		H Hex	J Hex
		inch	mm	inch	mm	inch	mm	inch	inch
#									
10756-4-4	1/4-18	1/4	6	2.03	52	1-1/16	27	9/16	11/16
10756-4-5	1/4-18	5/16	8	2.09	53	1-1/16	27	9/16	11/16
10756-6-6	3/8-18	3/8	10	2.13	54	1-1/8	28	11/16	7/8
10756-8-8	1/2-14	1/2	13	2.40	61	1-5/16	33	7/8	1
10756-12-12	3/4-14	3/4	19	2.98	76	1-5/8	41	1-1/16	1-1/4
10756-16-16	1-11-1/2	1	25	3.74	95	1-7/8	48	1-3/8	1-1/2



WARNING

This product can expose you to chemicals including Lead, which is known to the State of California to cause cancer and birth defects or other reproductive harm. For more information go to www.P65Warnings.ca.gov.

10856 Female SAE 45° Swivel

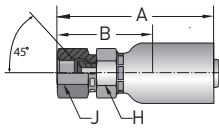

Construction: Steel. Add "C" for Stainless Steel.

Part Number	Thread Size	Hose I.D.		A		Cutoff Allow. B		H Hex	J Hex
		inch	mm	inch	mm	inch	mm	inch	inch
#									
10856-6-4	5/8-18	1/4	6	2.19	56	1-1/4	32	11/16	3/4
10856-6-5	5/8-18	5/16	8	2.28	58	1-1/4	32	11/16	3/4
10856-6-6	5/8-18	3/8	10	2.36	60	1-3/8	35	11/16	3/4
10856-12-12	1-1/16-14	3/4	19	3.06	78	1-3/4	44	1-1/16	1-1/4

11356 Male Pipe Swivel

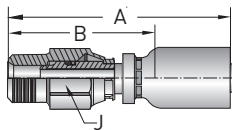

Construction: Steel. Add "C" for Stainless Steel.
 WARNING: Fittings allow minor movement to relieve stress on hose but are not recommended for continued or extensive swiveling. Not recommended for use in CNG applications

Part Number	Thread Size	Hose I.D.		A		Cutoff Allow. B		J Hex
		inch	mm	inch	mm	inch	mm	inch
#								
11356-2-2	1/8-27	1/8	3	1.96	50	1-5/16	33	1/2
11356-2-3	1/8-27	3/16	5	2.17	73	1-1/2	54	5/8
11356-4-3	1/4-18	3/16	5	2.59	66	1-7/8	48	5/8
11356-4-4	1/4-18	1/4	6	2.95	75	2	50	5/8
11356-4-5	1/4-18	5/16	8	2.77	75	1-3/4	49	5/8
11356-6-6	3/8-18	3/8	10	3.06	78	2-1/16	52	3/4
11356-8-6	1/2-14	3/8	10	3.24	82	2-1/4	57	7/8
11356-8-8	1/2-14	1/2	13	3.37	86	2-1/4	57	7/8
11356-12-12	3/4-14	3/4	19	3.71	94	2-3/8	60	1-1/4
11356-16-16	1-11-1/2	1	25	4.35	118	2-7/16	70	1-1/2

NOTE: Nitrile O-ring. See O-ring Material Selection section, pg. G-43.

13E56 Male (JIC) 37° Long

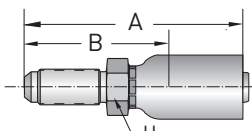

Construction: Steel. Add "C" for Stainless Steel.

Part Number	Thread Size	Hose I.D.		A		Cutoff Allow. B		H Hex
		inch	mm	inch	mm	inch	mm	inch
#								
13E56-4-4	7/16-20	1/4	6	2.80	71	1-13/16	46	5/8
13E56-6-5	9/16-18	5/16	8	2.97	75	1-15/16	49	3/4
13E56-6-6	9/16-18	3/8	10	2.97	75	2	50	7/8
13E56-8-8	3/4-16	1/2	13	3.24	82	2-1/8	54	7/8

NOTE: Bulkhead Locknut sold separately. WLN Locknuts are manufactured by the Tube Fittings Division. Refer to Catalog 4300 for additional information.



WARNING

This product can expose you to chemicals including Lead, which is known to the State of California to cause cancer and birth defects or other reproductive harm. For more information go to www.P65Warnings.ca.gov.

A Hose

B Tubing

C Coiled Air Hose & Fittings

D Transportation

E Fittings

F Tooling, Equipment & Accessories

G General Technical

A Hose

13756 Female JIC 37° Swivel 45° Elbow

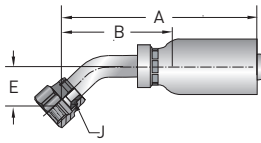

Construction: Steel. Add "C" for Stainless Steel.

Part Number	Thread Size	Hose I.D.		A		Cutoff Allow. B		E		J Hex
		inch	mm	inch	mm	inch	mm	inch	mm	inch
#										
13756-4-2	7/16-20	1/8	3	1.98	50	1-5/16	33	.33	8	9/16
13756-4-3	7/16-20	3/16	5	1.93	49	1-1/4	32	.39	10	9/16
13756-4-4	7/16-20	1/4	6	2.19	56	1-1/4	32	.39	10	9/16
13756-5-4	1/2-20	1/4	6	2.46	62	1-1/2	38	.39	10	5/8
13756-6-4	9/16-18	1/4	6	2.24	57	1-1/4	32	.43	11	11/16
13756-6-5	9/16-18	5/16	8	2.53	64	1-1/2	38	.43	11	11/16
13756-6-6	9/16-18	3/8	10	2.57	65	1-9/16	40	.43	11	11/16
13756-8-6	3/4-16	3/8	10	2.76	70	1-3/4	44	.59	15	7/8
13756-8-8	3/4-16	1/2	13	2.72	69	1-5/8	41	.59	15	7/8
13756-10-8	7/8-14	1/2	13	2.87	73	1-3/4	45	.63	16	1
13756-10-10	7/8-14	5/8	16	3.23	83	2	50	.63	16	1
13756-12-10	1-1/16-12	5/8	16	3.74	95	2.40	61	.83	21	1-1/4
13756-12-12	1-1/16-12	3/4	19	4.03	102	2-11/16	68	.83	21	1-1/4
13756-16-16	1-5/16-12	1	25	4.53	115	2.63	67	.94	24	1-1/2

B Tubing

C Coiled Air Hose & Fittings

D Transportation

13956 Female JIC 37° Swivel 90° Elbow

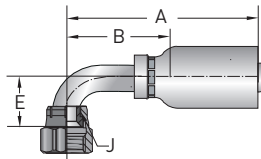

Construction: Steel. Add "C" for Stainless Steel.

Part Number	Thread Size	Hose I.D.		A		Cutoff Allow. B		E		J Hex
		inch	mm	inch	mm	inch	mm	inch	mm	inch
#										
13956-4-2	7/16-20	1/8	3	1.83	46	1-1/4	32	.68	17	9/16
13956-4-3	7/16-20	3/16	5	1.75	44	1-1/16	27	.83	21	9/16
13956-4-4	7/16-20	1/4	6	2.01	51	1-1/16	27	.83	21	9/16
13956-5-4	1/2-20	1/4	6	2.01	51	1-1/16	27	.83	21	5/8
13956-6-4	9/16-18	1/4	6	2.01	51	1-1/16	27	.91	23	11/16
13956-6-5	9/16-18	5/16	8	2.14	54	1-1/8	28	.91	23	11/16
13956-6-6	9/16-18	3/8	10	2.22	56	1-1/4	32	.91	23	11/16
13956-8-6	3/4-16	3/8	10	2.55	65	1-9/16	40	1.14	29	7/8
13956-8-8	3/4-16	1/2	13	2.48	63	1-3/8	35	1.14	29	7/8
13956-10-8	7/8-14	1/2	13	2.60	66	1-1/2	38	1.26	32	1
13956-10-10	7/8-14	5/8	16	2.96	75	1-5/8	41	1.26	32	1
13956-12-10	1-1/16-12	5/8	19	3.39	86	2-1/16	52	1.89	48	1-1/4
13956-12-12	1-1/16-12	3/4	19	3.89	99	2-9/16	65	1.89	48	1-1/4
13956-16-16	1-5/16-12	1	25	4.50	114	2.60	66	2.20	56	1-1/2

F Fittings

G Tooling, Equipment & Accessories

H General Technical



WARNING

This product can expose you to chemicals including Lead, which is known to the State of California to cause cancer and birth defects or other reproductive harm. For more information go to www.P65Warnings.ca.gov.

14156 Female JIC 37° Swivel 90° Elbow Long Drop

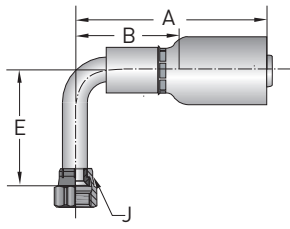

Construction: Steel. Add "C" for Stainless Steel.

Part Number	Thread Size	Hose I.D.		A		Cutoff Allow. B		E		J Hex
		inch	mm	inch	mm	inch	mm	inch	mm	inch
#										
14156-4-3	7/16-20	3/16	5	2.00	51	1-5/16	33	1.81	46	9/16
14156-4-4	7/16-20	1/4	6	2.31	59	1-3/8	35	1.81	46	9/16
14156-5-4	1/2-20	1/4	6	2.34	60	1-3/8	35	1.81	46	5/8
14156-6-4	9/16-18	1/4	6	2.39	61	1-7/16	36	2.13	54	11/16
14156-6-5	9/16-18	5/16	8	2.36	60	1-5/16	33	2.13	54	11/16
14156-6-6	9/16-18	3/8	10	2.39	61	1-3/8	35	2.13	54	11/16
14156-8-6	3/4-16	3/8	10	2.49	63	1-1/2	38	2.52	64	7/8
14156-8-8	3/4-16	1/2	13	2.61	66	1-1/2	38	2.52	64	7/8
14156-10-8	7/8-14	1/2	13	2.48	63	1-3/8	35	2.76	70	1
14156-12-12	1-1/16-12	3/4	19	3.59	91	2-1/4	57	3.78	96	1-1/4
14156-16-16	1-5/16-12	1	25	4.36	111	2-1/2	63	4.49	114	1-1/2

1L956 Female JIC 37° Swivel 90° Elbow Medium Drop

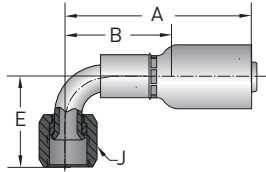

Construction: Steel. Add "C" for Stainless Steel.

Part Number	Thread Size	Hose I.D.		A		Cutoff Allow. B		E		J Hex
		inch	mm	inch	mm	inch	mm	inch	mm	inch
#										
1L956-4-3	7/16-20	3/16	5	1.97	50	1-1/4	32	1.26	32	9/16
1L956-4-4	7/16-20	1/4	6	2.29	58	1-5/16	34	1.26	32	9/16
1L956-5-4	1/2-20	1/4	6	2.31	59	1-3/8	35	1.26	32	5/8
1L956-6-5	9/16-18	5/16	8	2.33	59	1-5/16	34	1.50	38	11/16
1L956-6-6	9/16-18	3/8	10	2.36	60	1-1/4	31	1.50	38	11/16
1L956-8-6	3/4-16	3/8	10	2.44	62	1-7/16	37	1.61	41	7/8
1L956-8-8	3/4-16	1/2	13	2.57	65	1-7/16	37	1.61	41	7/8
1L956-10-8	7/8-14	1/2	13	2.48	63	1-3/8	35	1.85	47	1
1L956-12-12	1-1/16-12	3/4	19	3.89	99	2-9/16	65	2.28	58	1-1/4
1L956-16-16	1-5/16-12	1	25	4.36	111	2-1/2	63	2.80	71	1-1/2

14956 - Banjo Union DIN7642

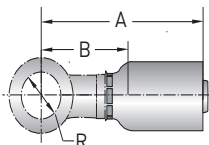

Construction: Steel.

Part Number	Diameter R	Hose I.D.		A		Cutoff Allow. B	
		mm	inch	mm	inch	mm	inch
#							
14956-14-3	14	5	3/16	49	1.93	31	1.22
14956-12-4	12	6	1/4	50	1.97	25	1.50
14956-14-4	14	6	1/4	56	2.20	32	1.26
14956-12-5	12	8	5/16	54	2.13	29	1.14
14956-14-5	14	8	5/16	53	2.09	27	1.06
14956-16-6	16	10	3/8	58	2.28	33	1.30
14956-17-6	17	10	3/8	55	2.17	29	1.14



WARNING

This product can expose you to chemicals including Lead, which is known to the State of California to cause cancer and birth defects or other reproductive harm. For more information go to www.P65Warnings.ca.gov.

A Hose

B Tubing

C Coiled Air Hose & Fittings

D Transportation

E Fittings

F Tooling, Equipment & Accessories

G General Technical

A Hose

1J056 Male Seal-Lok™ Rigid Straight w/O-ring ISO 12151-1-S

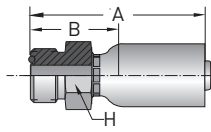

Construction: Steel. Add "C" for Stainless Steel.

Part Number	Thread Size	Hose I.D.		A		Cutoff Allow. B		H Hex		
		inch	mm	inch	mm	inch	mm	inch	mm	
#										
1J056-4-4	9/16-18	1/4	6	1.93	49	15/16	24	5/8		
1J056-6-4	11/16-16	1/4	6	2.01	51	1-1/16	27	3/4		
1J056-6-6	11/16-16	3/8	10	1.98	50	1	25	3/4		
1J056-8-6	13/16-16	1/2	13	2.16	55	1-3/16	30	7/8		
1J056-8-8	13/16-16	1/2	13	2.18	55	1-1/16	27	7/8		

B Tubing

C Coiled Air Hose & Fittings

1J156 Female Seal-Lok™ Swivel 90° Elbow Long Drop ISO 12151-1-SWEL90

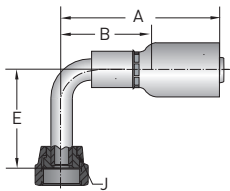

Construction: Steel. Add "C" for Stainless Steel.

Part Number	Thread Size	Hose I.D.		A		Cutoff Allow. B		E		J Hex
		inch	mm	inch	mm	inch	mm	inch	mm	inch
#										
1J156-4-3	9/16-18	3/16	5	2.05	52	1-3/8	35	1.81	46	11/16
1J156-4-4	9/16-18	1/4	6	2.37	60	1-3/8	35	1.81	46	11/16
1J156-6-4	11/16-16	1/4	6	2.45	62	1-1/2	38	2.13	54	13/16
1J156-6-6	11/16-16	3/8	10	2.45	62	1-7/16	37	2.13	54	13/16
1J156-8-6	13/16-16	3/8	10	2.53	64	1-7/16	37	2.52	64	15/16
1J156-8-8	13/16-16	1/2	13	2.67	68	1-9/16	40	2.52	64	15/16
1J156-12-12	1-3/16-12	3/4	19	3.59	91	2-1/4	57	3.78	96	1-3/8
1J156-16-16	1-7/16-12	1	25	4.36	111	2-1/2	63	4.49	114	1-5/8

D Transportation

1JC56 Female Seal-Lok™ Straight Swivel Short ISO 12151-1-SWSA

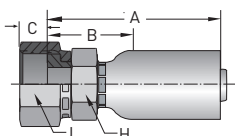

Construction: Steel. Add "C" for Stainless Steel.

Part Number	Thread Size	Hose I.D.		A		Cutoff Allow. B		C		H Hex	J Hex
		inch	mm	inch	mm	inch	mm	inch	mm	inch	inch
#											
1JC56-4-2	9/16-18	1/8	3	1.34	34	3/4	19	0.32	8	5/8	11/16
1JC56-4-3	9/16-18	3/16	5	1.58	40	7/8	22	.32	8	9/16	11/16
1JC56-4-4	9/16-18	1/4	6	1.86	47	7/8	22	.32	8	9/16	11/16
1JC56-6-4	11/16-16	1/4	6	1.90	48	15/16	24	.34	9	11/16	13/16
1JC56-4-5	9/16-18	5/16	8	1.81	46	13/16	21	.32	8	11/16	11/16
1JC56-6-5	11/16-16	5/16	8	1.95	49	15/16	24	.34	9	11/16	13/16
1JC56-4-6	9/16-18	3/8	10	1.91	48	15/16	24	.32	8	5/8	11/16
1JC56-6-6	11/16-16	3/8	10	1.89	48	7/8	22	.34	9	11/16	13/16
1JC56-8-6	13/16-16	3/8	10	2.00	51	1	25	.43	11	13/16	15/16
1JC56-8-8	13/16-16	1/2	13	2.13	54	1	25	.43	11	13/16	15/16
1JC56-10-8	1-14	1/2	13	2.30	58	1-3/16	30	.48	12	15/16	1-1/8
1JC56-10-10	1-14	5/8	16	2.48	63	1-3/16	30	.48	12	15/16	1-1/8
1JC56-12-10	1-3/16-12	5/8	16	2.61	66	1-5/16	33	.55	14	1-1/8	1-3/8
1JC56-10-12	1-14	3/4	19	2.50	64	1-3/16	30	.48	12	1-1/8	1-1/8
1JC56-12-12	1-3/16-12	3/4	19	2.54	65	1-3/16	30	.55	14	1-1/8	1-3/8
1JC56-16-16	1-7/16-12	1	25	3.21	82	1-5/16	33	.56	14	1-3/8	1-5/8

F Fittings

G Tooling, Equipment & Accessories

WARNING This product can expose you to chemicals including Lead, which is known to the State of California to cause cancer and birth defects or other reproductive harm. For more information go to www.P65Warnings.ca.gov.

G General Technical

1J556 Female Seal-Lok™ Straight ISO 12151-1-SWSB

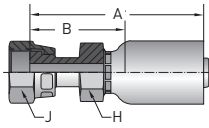

Construction: Steel. Add "C" for Stainless Steel.

Part Number	Thread Size	Hose I.D.		A		Cutoff Allow. B		H Hex		J Hex
		inch	mm	inch	mm	inch	mm	inch	inch	
#										
1J556-4-3	9/16-18	3/16	5	1.89	48	1-3/16	30	9/16	11/16	
1J556-4-4	9/16-18	1/4	6	2.17	51	1-3/16	30	9/16	11/16	
1J556-6-4	11/16-16	1/4	6	2.24	57	1-1/4	32	11/16	13/16	
1J556-6-5	11/16-16	5/16	8	2.29	58	1-1/4	32	11/16	13/16	
1J556-6-6	11/16-16	3/8	10	2.28	58	1-5/16	33	11/16	13/16	
1J556-8-6	13/16-16	3/8	10	2.40	61	1-7/16	36	13/16	15/16	
1J556-6-8	11/16-16	1/2	13	2.40	61	1-5/16	33	3/4	13/16	
1J556-8-8	13/16-16	1/2	13	2.52	64	1-3/8	35	13/16	15/16	
1J556-10-8	1-14	1/2	13	2.68	68	1-9/16	40	15/16	1-1/8	
1J556-10-10	1-14	5/8	16	2.92	74	1-5/8	41	15/16	1-1/8	
1J556-12-12	1-3/16-12	3/4	19	3.17	81	1-13/16	46	1-1/8	1-3/8	
1J556-16-16	1-7/16-12	1	25	3.76	96	1-7/8	48	1-3/8	1-5/8	

1J256 Female Seal-Lok™ Swivel 30° Elbow

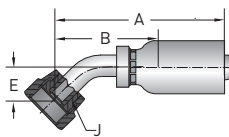

Construction: Steel. Add "C" for Stainless Steel.

Part Number	Thread Size	Hose I.D.		A		Cutoff Allow. B		E		J Hex
		inch	mm	inch	mm	inch	mm	inch	mm	inch
#										
1J256-8-8	13/16-16	1/2	13	2.84	72	1-11/16	43	.43	11	15/16

1J556 Female Seal-Lok™ Swivel 90° Elbow Medium Drop ISO 12151-1-SWEM90

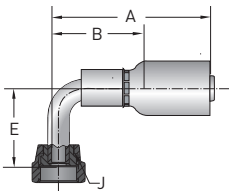

Construction: Steel. Add "C" for Stainless Steel.

Part Number	Thread Size	Hose I.D.		A		Cutoff Allow. B		E		J Hex
		inch	mm	inch	mm	inch	mm	inch	mm	inch
#										
1J556-4-3	9/16-18	3/16	5	1.89	48	1-3/16	30	1.26	32	11/16
1J556-4-4	9/16-18	1/4	6	2.14	53	1-1/8	28	1.26	32	11/16
1J556-6-4	11/16-16	1/4	6	2.14	55	1-3/16	30	1.50	38	13/16
1J556-6-5	11/16-16	5/16	8	2.28	58	1-1/4	32	1.50	38	13/16
1J556-6-6	11/16-16	3/8	10	2.42	61	1-7/16	36	1.50	38	13/16
1J556-8-6	13/16-16	3/8	10	2.22	56	1-1/4	32	1.61	41	15/16
1J556-8-8	13/16-16	1/2	13	2.48	63	1-3/8	35	1.61	41	15/16
1J556-10-8	1-14	1/2	13	2.48	63	1-3/8	35	1.85	47	1-1/8
1J556-10-10	1-14	5/8	16	2.83	72	1-1/2	38	1.85	47	1-1/8
1J556-12-12	1-3/16-12	3/4	19	3.59	91	2-1/4	57	2.28	58	1-3/8
1J556-16-16	1-7/16-12	1	25	4.36	111	2-1/2	63	2.80	71	1-5/8



WARNING

This product can expose you to chemicals including Lead, which is known to the State of California to cause cancer and birth defects or other reproductive harm. For more information go to www.P65Warnings.ca.gov.

A Hose

B Tubing

C Coiled Air Hose & Fittings

D Transportation

E Fittings

F Tooling, Equipment & Accessories

G General Technical

A Hose

1J756 Female Seal-Lok™ Swivel 45° Elbow ISO 12151-1-SWE45

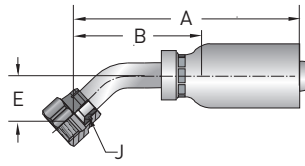

Construction: Steel. Add "C" for Stainless Steel.

Part Number	Thread Size	Hose I.D.		A		Cutoff Allow. B		E		J Hex
		inch	mm	inch	mm	inch	mm	inch	mm	inch
#										
1J756-4-2	9/16-18	1/8	3	2.07	53	1-7/16	36	0.39	10	11/16
1J756-4-3	9/16-18	3/16	5	2.00	51	1-5/16	33	.39	10	11/16
1J756-4-4	9/16-18	1/4	6	2.25	57	1-1/4	32	.39	10	11/16
1J756-6-4	11/16-16	1/4	6	2.27	58	1-5/16	33	.43	11	13/16
1J756-6-5	11/16-16	5/16	8	2.32	59	1-3/8	35	.43	11	13/16
1J756-4-6	9/16-18	3/8	10	2.25	57	1-1/4	32	.39	10	11/16
1J756-6-6	11/16-16	3/8	10	2.35	60	1-3/8	35	.43	11	13/16
1J756-8-6	13/16-16	3/8	10	2.54	65	1-9/16	40	.59	15	15/16
1J756-8-8	13/16-16	1/2	13	2.72	69	1-5/8	41	.59	15	15/16
1J756-10-10	1-14	5/8	16	3.27	83	2	50	.63	16	1-1/8
1J756-12-12	1-3/16-12	3/4	19	4.03	102	2-11/16	68	.83	21	1-3/8
1J756-16-16	1-7/16-12	1	25	4.53	115	2.63	67	.94	24	1-5/8

B Tubing

C Coiled Air Hose & Fittings

1J956 Female Seal-Lok™ Swivel 90° Elbow Short Drop ISO 12151-1-SWE90

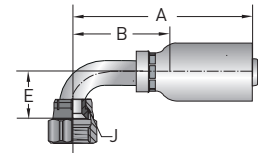

Construction: Steel. Add "C" for Stainless Steel.

Part Number	Thread Size	Hose I.D.		A		Cutoff Allow. B		E		J Hex
		inch	mm	inch	mm	inch	mm	inch	mm	inch
#										
1J956-4-2	9/16-18	1/8	3	2.04	52	1-7/16	36	0.83	21	11/16
1J956-4-3	9/16-18	3/16	5	1.89	48	1-3/16	30	.83	21	11/16
1J956-4-4	9/16-18	1/4	6	2.14	53	1-1/8	28	.83	21	11/16
1J956-6-4	11/16-16	1/4	6	2.14	55	1-3/16	30	.91	23	13/16
1J956-6-5	11/16-16	5/16	8	2.28	58	1-1/4	32	.91	23	13/16
1J956-6-6	11/16-16	3/8	10	2.22	56	1-1/4	32	.91	23	13/16
1J956-8-6	13/16-16	3/8	10	2.22	56	1-1/4	32	1.14	29	15/16
1J956-8-8	13/16-16	1/2	13	2.48	63	1-3/8	35	1.14	29	15/16
1J956-10-8	1-14	1/2	13	2.48	63	1-3/8	35	1.26	32	1-1/8
1J956-10-10	1-14	5/8	16	3.14	80	1-13/16	46	1.26	32	1-1/8
1J956-12-12	1-3/16-12	3/4	19	3.89	99	2-9/16	65	1.89	48	1-3/8
1J956-16-16	1-7/16-12	1	25	4.50	114	2.60	66	2.20	56	1-5/8

D Transportation

F Fittings

1TU56 Universal Inch Tube Stub End

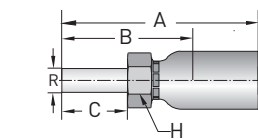

Construction: Steel. Add "C" for Stainless Steel.

Part Number	Diameter R	Hose I.D.		A		Cutoff Allow. B		C		H Hex
		inch	mm	inch	mm	inch	mm	inch	mm	inch
#										
1TU56-4-4	1/4	1/4	6	2.35	60	1-3/8	35	.72	18	5/8
1TU56-6-4	3/8	1/4	6	2.41	61	1-7/16	36	.78	20	11/16
1TU56-6-6	3/8	3/8	10	2.46	62	1-7/16	36	.78	20	3/4
1TU56-8-8	1/2	1/2	13	2.68	68	1-9/16	40	1.03	26	3/4
1TU56-12-12	3/4	3/4	19	2.88	73	1-9/16	40	1.03	26	1
1TU56-16-16	1	1	25	4.03	102	1-7/8	48	1.03	26	1-1/4

NOTE: Use with A-Lok & CPI nuts, sleeves and adapters. These components are manufactured by Parker's Instrumentation Connectors Division. Refer to Catalog 4230/4233 for additional information.



WARNING

This product can expose you to chemicals including Lead, which is known to the State of California to cause cancer and birth defects or other reproductive harm. For more information go to www.P65Warnings.ca.gov.

T Tooling, Equipment & Accessories

G General Technical

10C56 – Metric Female Swivel 24° With O-ring 45° Elbow Heavy Series, ISO 12151-2

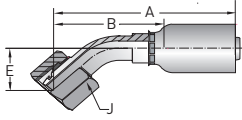

Construction: Steel. Add "C" for Stainless Steel.

Part Number	Thread Size	Hose I.D.		A		Cutoff Allow. B		E		J Hex
		mm	inch	mm	inch	mm	inch	mm	inch	mm
#										
10C56-6-3	M14x1.5	5.0	3/16	58	2.28	40	1.57	16	0.63	17
10C56-8-3	M16x1.5	5	3/16	59	2.32	41	1.61	18	0.71	19
10C56-10-4	M18x1.5	6	1/4	64	2.52	40	1.57	17	0.67	22
10C56-12-5	M20x1.5	8	5/16	69	2.72	43	1.69	17	0.67	24
10C56-12-6	M20x1.5	10	3/8	75	2.95	49	1.93	20	0.79	24
10C56-16-8	M24x1.5	13	1/2	80	3.15	51	2.01	23	0.91	30

11C56 – Metric Female Swivel 24° With O-ring 90° Elbow Heavy Series, ISO 12151-2

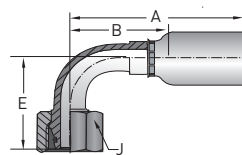

Construction: Steel. Add "C" for Stainless Steel.

Part Number	Thread Size	Hose I.D.		A		Cutoff Allow. B		E		J Hex
		mm	inch	mm	inch	mm	inch	mm	inch	mm
#										
11C56-8-3	M16x1.5	5	3/16	48	1.89	30	1.18	29	1.14	19
11C56-10-4	M18x1.5	6	1/4	53	2.09	29	1.14	32	1.26	22
11C56-12-5	M20x1.5	8	5/16	65	2.56	39	1.54	34	1.34	24
11C56-12-6	M20x1.5	10	3/8	63	2.48	38	1.50	37	1.46	24
11C56-16-8	M24x1.5	13	1/2	68	2.68	40	1.57	45	1.77	30

19256 Female BSP Parallel Pipe Swivel Straight (60° Cone)

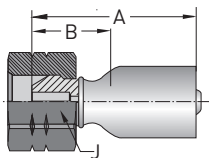

Construction: Steel. Add "C" for Stainless Steel.

Part Number	Thread Size	Hose I.D.		A		Cutoff Allow. B		J Hex
		mm	inch	mm	inch	mm	inch	mm
#								
19256-4-3	G 1/4	5	3/16	35	1.38	17	0.67	19
19256-2-4	G 1/8	6	1/4	43	1.69	18	0.71	14
19256-4-4	G 1/4	6	1/4	42	1.65	17	0.67	19
19256-6-4	G 3/8	6	1/4	45	1.77	20	0.79	22
19256-4-5	G 1/4	8	5/16	47	1.85	21	0.83	19
19256-6-5	G 3/8	8	5/16	46	1.81	20	0.79	22
19256-6-6	G 3/8	10	3/8	46	1.81	21	0.83	22
19256-8-6	G 1/2	10	3/8	48	1.77	23	0.91	27
19256-6-8	G 3/8	13	1/2	53	2.09	25	0.98	22
19256-8-8	G 1/2	13	1/2	51	2.01	23	0.91	27
19256-10-8	G 5/8	13	1/2	49	1.93	22	0.87	30
19256-12-12	G 3/4	19	3/4	60	2.36	26	1.02	32
19256-16-16	G 1	25	1	74	2.91	26	1.02	41



WARNING

This product can expose you to chemicals including Lead, which is known to the State of California to cause cancer and birth defects or other reproductive harm. For more information go to www.P65Warnings.ca.gov.

A Hose

B Tubing

C Coiled Air Hose & Fittings

D Transportation

E Fittings

F Tooling, Equipment & Accessories

G General Technical

A Hose

1AL56 A-LOK® Compression (With Nut and Ferrule)

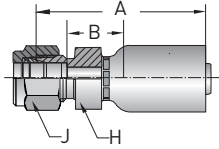

Construction: 316 Stainless nipple and shell.

Part Number	Thread Size	Hose I.D.		A		Cutoff Allow. B		H Hex	J Hex
		inch	mm	inch	mm	inch	mm	mm	mm
#									
1AL56-4-4	7/16-20	1/4	6	1/4	6	1.91	49	9/16	9/16
1AL56-6-6	9/16-20	3/8	10	3/8	10	2.09	53	11/16	11/16
1AL56-8-8	3/4-20	1/2	13	3/8	10	2.21	56	7/8	7/8

NOTE: Nut part No. is XNUX or XNUX-316 for stainless steel.
 Front ferrule part No. is XFFX or XFFX-316 for stainless steel.
 Back ferrule part No. is XBFX or XBFX-316 for stainless steel.
 X denotes dash size.

B Tubing

1B156 - Female BSP Parallel Pipe Swivel 45° Elbow (60° Cone) ISO 228-1

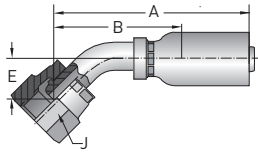

Construction: Steel. Add "C" for Stainless Steel.

Part Number	Thread Size	Hose I.D.		A		Cutoff Allow. B		E		J Hex
		mm	inch	mm	inch	mm	inch	mm	inch	mm
#										
1B156-4-3	G 1/4	5	3/16	57	2.24	15	0.59	39	1.542	19
1B156-4-4	G 1/4	6	1/4	62	2.44	15	0.59	38	1.50	19
1B156-6-5	G 3/8	8	5/16	65	2.56	17	0.67	39	1.54	22
1B156-6-6	G 3/8	10	3/8	67	2.64	17	0.67	42	1.65	22
1B156-8-8	G 1/2	13	1/2	77	3.03	20	0.79	48	1.89	27
1B156-12-12	G 3/4	19	3/4	99	3.90	25	1.00	65	2.56	32
1B156-16-16	G 1	25	1	127	5.00	31	1.22	79	3.11	41

C Coiled Air Hose & Fittings

1B256 - Female BSP Parallel Pipe Swivel 90° Elbow (60° Cone) ISO 228-1

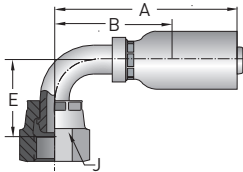

Construction: Steel. Add "C" for Stainless Steel.

Part Number	Thread Size	Hose I.D.		A		Cutoff Allow. B		E		J Hex
		mm	inch	mm	inch	mm	inch	mm	inch	mm
#										
1B256-4-3	G 1/4	5	3/16	48	1.89	28	1.10	30	1.18	19
1B256-4-4	G 1/4	6	1/4	53	2.09	28	1.10	29	1.14	19
1B256-4-5	G 1/4	8	5/16	56	2.20	34	1.34	30	1.18	19
1B256-6-5	G 3/8	8	5/16	55	2.16	30	1.18	30	1.18	22
1B256-6-6	G 3/8	10	3/8	60	2.36	33	1.30	31	1.22	22
1B256-8-8	G 1/2	13	1/2	70	2.76	40	1.57	42	1.65	27
1B256-12-12	G 3/4	19	3/4	92	3.62	52	2.05	58	2.28	32
1B256-16-16	G 1	25	1	125	4.92	68	2.68	77	3.03	41

D Transportation

1B456 - Female BSP Parallel Swivel 90° Elbow Block Type (60° Cone) ISO 228-1

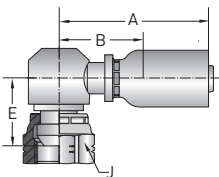

Construction: Steel.

Part Number	Thread Size	Hose I.D.		A		Cutoff Allow. B		E		J Hex
		mm	inch	mm	inch	mm	inch	mm	inch	mm
#										
1B456-4-4	G 1/4	6	1/4	47	1.85	22	0.87	22	0.87	19
1B456-6-6	G 3/8	10	3/8	52	2.05	27	1.06	25	0.98	22
1B456-8-8	G 1/2	13	1/2	58	2.28	29	1.14	29	1.14	27

F Fittings

WARNING This product can expose you to chemicals including Lead, which is known to the State of California to cause cancer and birth defects or other reproductive harm. For more information go to www.P65Warnings.ca.gov.

G Tooling, Equipment & Accessories

General Technical

1C356 – Metric Female Swivel Nut Light Series, 24°/60°

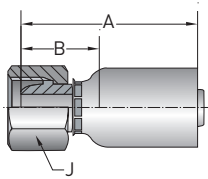

Construction: Steel. Add "C" for Stainless Steel.

Part Number	Thread Size	Hose I.D.		A		Cutoff Allow. B		J Hex	
		mm	inch	mm	inch	mm	inch	mm	inch
#		⊙						⬡	
1C356-6-3	M12x1.5	5	3/16	37	1.46	20	0.79	14	
1C356-8-4	M14x1.5	6	1/4	44	1.73	20	0.79	17	
1C356-10-4	M16x1.5	6	1/4	45	1.77	21	0.83	19	
1C356-10-5	M16x1.5	8	5/16	46	1.81	20	0.79	19	
1C356-12-5	M18x1.5	8	5/16	47	1.85	21	0.83	22	
1C356-10-6	M16x1.5	10	3/8	46	1.81	21	0.83	19	
1C356-12-6	M18x1.5	10	3/8	47	1.85	21	0.83	22	
1C356-15-6	M22x1.5	10	3/8	46	1.81	21	0.83	27	
1C356-15-8	M22x1.5	13	1/2	50	1.97	21	0.83	27	
1C356-18-10	M26x1.5	16	5/8	57	2.24	25	0.98	32	
1C356-18-12	M26x1.5	19	3/4	58	2.28	24	0.94	32	
1C356-22-12	M30x2	19	3/4	60	2.36	27	1.06	36	

1C456 – Metric Female Swivel 45° Elbow Light Series, 24°/60°

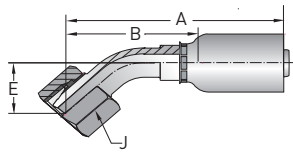

Construction: Steel. Add "C" for Stainless Steel.

Part Number	Thread Size	Hose I.D.		A		Cutoff Allow. B		E		J Hex
		mm	inch	mm	inch	mm	inch	mm	inch	mm
#		⊙								⬡
1C456-6-3	M12x1.5	5	3/16	57	2.24	40	1.57	16	0.63	14
1C456-8-4	M14x1.5	6	1/4	60	2.36	36	1.42	14	0.55	17
1C456-10-5	M16x1.5	8	5/16	62	2.44	37	1.46	15	0.59	19
1C456-10-6	M16x1.5	10	3/8	67	2.64	41	1.61	17	0.67	19
1C456-12-6	M18x1.5	10	3/8	72	2.83	47	1.85	18	0.71	22
1C456-15-8	M22x1.5	13	1/2	76	2.99	48	1.89	19	0.75	27

1C556 – Metric Female Swivel 90° Elbow Light Series, 24°/60°

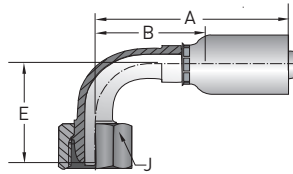

Construction: Steel. Add "C" for Stainless Steel.

Part Number	Thread Size	Hose I.D.		A		Cutoff Allow. B		E		J Hex
		mm	inch	mm	inch	mm	inch	mm	inch	mm
#		⊙								⬡
1C556-6-3	M12x1.5	5	3/16	48	1.89	30	1.18	30	1.18	14
1C556-8-4	M14x1.5	6	1/4	53	2.09	28	1.10	26	1.02	17
1C556-10-4	M16x1.5	6	1/4	53	2.09	28	1.10	27	1.06	19
1C556-12-5	M18x1.5	8	5/16	58	2.28	33	1.30	34	1.34	22
1C556-10-6	M16x1.5	10	3/8	63	2.48	38	1.50	33	1.30	19
1C556-12-6	M18x1.5	10	3/8	63	2.48	38	1.50	34	1.34	22
1C556-15-8	M22x1.5	13	1/2	72	2.83	44	1.73	39	1.54	27
1C556-18-12	M26x1.5	19	3/4	87	3.43	53	2.09	52	2.05	32



WARNING

This product can expose you to chemicals including Lead, which is known to the State of California to cause cancer and birth defects or other reproductive harm. For more information go to www.P65Warnings.ca.gov.

A Hose

B Tubing

C Coiled Air Hose & Fittings

D Transportation

E Fittings

F Tooling, Equipment & Accessories

G General Technical

A Hose

1C656 – Female Metric Swivel DIN 20078 Heavy Series (Without O-ring) ISO 8434-1

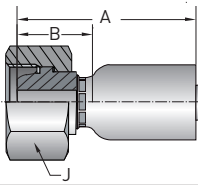

Construction: Steel. Add "C" for Stainless Steel.

Part Number	Thread Size	Hose I.D.		A		Cutoff Allow. B		J Hex
		mm	inch	mm	inch	mm	inch	mm
#								
1C656-8-3	M16x1.5	5	3/16	38	1.50	20	0.79	19
1C656-10-4	M18x1.5	6	1/4	47	1.85	22	0.87	22
1C656-12-5	M20x1.5	8	5/16	50	1.97	24	0.94	24
1C656-12-6	M20x1.5	10	3/8	49	1.93	24	0.94	24
1C656-14-6	M22x1.5	10	3/8	49	1.93	23	0.89	27
1C656-16-8	M24x1.5	10	1/2	53	2.09	25	0.98	30
1C656-20-12	M30x2	13	3/4	61	2.40	27	1.06	36

B Tubing

C Coiled Air Hose & Fittings

1C956 – Female Metric Swivel DIN 20078 Heavy Series (With O-ring) ISO 12151-2-SWS

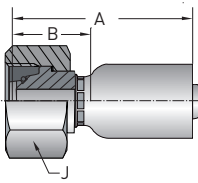

Construction: Steel. Add "C" for Stainless Steel.

Part Number	Thread Size	Hose I.D.		A		Cutoff Allow. B		J Hex
		mm	inch	mm	inch	mm	inch	mm
#								
1C956-8-3	M16x1.5	5	3/16	41	1.61	23	0.91	19
1C956-8-4	M16x1.5	6	1/4	48	1.89	23	0.91	19
1C956-10-4	M18x1.5	6	1/4	48	1.89	23	0.91	22
1C956-12-4	M20x1.5	6	1/4	48	1.89	24	0.94	24
1C956-10-5	M18x1.5	8	5/16	49	1.93	23	0.91	22
1C956-12-5	M20x1.5	8	5/16	50	1.97	24	0.94	24
1C956-12-6	M20x1.5	10	3/8	49	1.93	24	0.94	24
1C956-14-6	M22x1.5	10	3/8	49	1.93	24	0.94	27
1C956-16-8	M24x1.5	13	1/2	56	2.17	27	1.06	30
1C956-20-12	M30x2	19	3/4	65	2.56	31	1.22	36
1C956-25-12	M36x2	19	3/4	66	2.60	32	1.30	46

D Transportation

1CA56 – Metric Female Swivel 24° With O-ring Light Series, ISO 12151-2-SWS

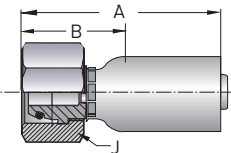

Construction: Steel. Add "C" for Stainless Steel.

Part Number	Thread Size	Hose I.D.		A		Cutoff Allow. B		J Hex
		mm	inch	mm	inch	mm	inch	mm
#								
1CA56-6-3	M12x1.5	5	3/16	40	1.57	22	0.87	14
1CA56-6-4	M12x1.5	6	1/4	48	1.89	24	0.94	14
1CA56-8-4	M14x1.5	6	1/4	47	1.85	23	0.91	17
1CA56-10-4	M16x1.5	6	1/4	47	1.85	22	0.87	19
1CA56-12-4	M18x1.5	6	1/4	47	1.85	22	0.87	22
1CA56-10-5	M16x1.5	8	5/16	48	1.89	22	0.87	19
1CA56-12-5	M18x1.5	8	5/16	48	1.89	22	0.87	22
1CA56-10-6	M16x1.5	10	3/8	48	1.89	22	0.87	19
1CA56-12-6	M18x1.5	10	3/8	48	1.89	22	0.87	22
1CA56-15-6	M22x1.5	10	3/8	50	1.97	25	0.98	27
1CA56-12-8	M18x1.5	13	1/2	53	2.09	27	1.06	22
1CA56-15-8	M22x1.5	13	1/2	53	2.09	25	0.98	27
1CA56-18-8	M26x1.5	13	1/2	53	2.09	25	0.98	32
1CA56-18-10	M26x1.5	16	5/8	60	2.36	26	1.02	32
1CA56-18-12	M26x1.5	19	3/4	60	2.36	26	1.02	32
1CA56-22-12	M30x2	19	3/4	62	2.44	28	1.10	36
1CA56-28-16	M36x2	25	1	77	3.03	28	1.10	41

F Fittings

G Tooling, Equipment & Accessories

H General Technical



WARNING

This product can expose you to chemicals including Lead, which is known to the State of California to cause cancer and birth defects or other reproductive harm. For more information go to www.P65Warnings.ca.gov.

1CE56 – Metric Female Swivel 24° With O-ring 45° Elbow Light Series, ISO 12151-2-SWE45

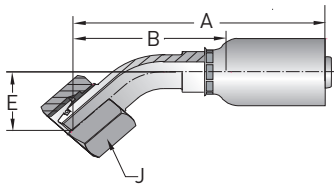

Construction: Steel. Add "C" for Stainless Steel.

Part Number	Thread Size	Hose I.D.		A		Cutoff Allow. B		E		J Hex
		mm	inch	mm	inch	mm	inch	mm	inch	mm
#										
1CE56-6-3	M12x1.5	5	3/16	58	2.28	40	1.57	17	0.67	14
1CE56-8-4	M14x1.5	6	1/4	65	2.56	40	1.57	18	0.71	17
1CE56-10-4	M16x1.5	6	1/4	62	2.44	38	1.50	16	0.63	19
1CE56-10-5	M16x1.5	8	5/16	72	2.83	46	1.81	18	0.71	19
1CE56-10-6	M16x1.5	10	3/8	75	2.95	50	1.97	19	0.75	19
1CE56-12-6	M18x1.5	10	3/8	73	2.87	48	1.89	19	0.75	22
1CE56-15-8	M22x1.5	13	1/2	78	3.07	50	1.97	22	0.87	27
1CE56-18-10	M26x1.5	16	5/8	89	3.50	56	2.20	24	0.94	32
1CE56-18-12	M26x1.5	19	3/4	101	3.74	67	2.64	27	1.06	32
1CE56-22-12	M30x2	19	3/4	100	3.94	66	2.60	26	1.02	36
1CE56-28-16	M36x2	25	1	133	5.27	85	3.35	33	1.30	41

1CF56 – Metric Female Swivel 24° With O-ring 90° Elbow Light Series, ISO 12151-2-SWE90

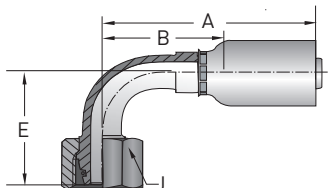

Construction: Steel. Add "C" for Stainless Steel.

Part Number	Thread Size	Hose I.D.		A		Cutoff Allow. B		E		J Hex
		mm	inch	mm	inch	mm	inch	mm	inch	mm
#										
1CF56-6-3	M12x1.5	5	3/16	48	1.89	30	1.18	30	1.18	14
1CF56-6-4	M12x1.5	6	1/6	53	2.09	29	1.14	33	1.30	14
1CF56-8-4	M14x1.5	6	1/6	55	2.17	30	1.18	29	1.14	17
1CF56-10-4	M16x1.5	6	1/6	55	2.17	31	1.22	29	1.14	17
1CF56-10-5	M16x1.5	8	5/16	66	2.60	40	1.57	29	1.14	19
1CF56-12-5	M18x1.5	8	5/16	65	2.56	40	1.57	30	1.18	22
1CF56-10-6	M16x1.5	10	3/8	64	2.52	39	1.54	37	1.46	19
1CF56-12-6	M18x1.5	10	3/8	63	2.48	38	1.50	35	1.38	22
1CF56-15-8	M22x1.5	13	1/2	68	2.68	40	1.57	43	1.69	27
1CF56-18-10	M26x1.5	16	5/8	79	3.11	45	1.77	52	2.05	32
1CF56-22-12	M30x2	19	3/4	91	3.58	57	2.24	55	2.17	36
1CF56-28-16	M36x2	25	1	122	5.0	74	2.91	71	2.80	41

1FU56 – (JIS) /BSP 30° Flare Swivel Female

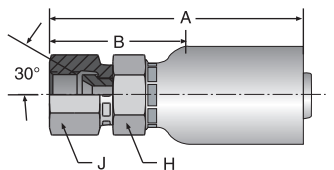

Construction: Steel. Add "C" for Stainless Steel.

Part Number	Thread Size	Hose I.D.		A		Cutoff Allow. B		H Hex	J Hex
		inch	mm	inch	mm	inch	mm	mm	mm
#									
1FU56-4-4	G 1/4-19	1/4	6	2.19	56	1 1/4	31	19	19
1FU56-6-6	G 3/8-19	3/8	10	2.36	60	1 3/8	35	22	22
1FU56-8-8	G 1/2-14	1/2	13	2.68	68	1 9/16	40	27	27
1FU56-12-12	G 3/4-14	3/4	19	3.02	77	1 11/16	43	36	36
1FU56-16-16	G 1-11	1	25	3.76	96	1 7/8	48	41	41



WARNING

This product can expose you to chemicals including Lead, which is known to the State of California to cause cancer and birth defects or other reproductive harm. For more information go to www.P65Warnings.ca.gov.

Hose
A

Tubing
B

Coiled Air Hose
& Fittings
C

Transportation
D

Fittings
E

Tooling,
Equipment
& Accessories
F

General
Technical
G

A Hose

1D056 - Male Stud DIN 20078 Light Series, ISO 8434-1

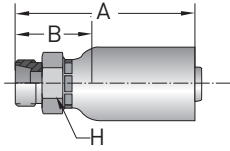

Construction: Steel. Add "C" for Stainless Steel.

B Tubing

C Coiled Air Hose & Fittings

D Transportation

F Fittings

G Tooling, Equipment & Accessories

H General Technical

Part Number	Thread Size	Hose I.D.		A		Cutoff Allow. B		H Hex
		mm	inch	mm	inch	mm	inch	mm
#								
1D056-6-3	M12x1.5	5	3/16	41	1.61	23	0.91	12
1D056-6-4	M12x1.5	6	1/4	48	1.89	23	0.91	12
1D056-8-4	M14x1.5	6	1/4	47	1.85	23	0.91	14
1D056-10-5	M16x1.5	8	5/16	50	1.97	24	0.94	17
1D056-12-5	M18x1.5	8	5/16	52	2.05	26	1.02	19
1D056-10-6	M16x1.5	10	3/8	50	1.97	24	0.94	17
1D056-12-6	M18x1.5	10	3/8	50	1.97	24	0.94	19
1D056-15-6	M22x1.5	10	3/8	52	2.05	27	1.06	22
1D056-15-8	M22x1.5	13	1/2	55	2.16	27	1.06	22
1D056-18-10	M26x1.5	16	5/8	64	2.52	30	1.18	27
1D056-22-12	M30x2	19	3/4	68	2.68	34	1.34	30
1D056-28-16	M36x2	25	1	82	3.23	34	1.34	36

1D256 - Metric Male Stud 24° Heavy Series, ISO 12151-2

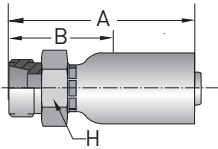

Construction: Steel. Add "C" for Stainless Steel.

Part Number	Thread Size	Hose I.D.		A		Cutoff Allow. B		H Hex
		mm	inch	mm	inch	mm	inch	mm
#								
1D256-8-3	M16x1.5	5	3/16	42	1.65	25	0.98	12
1D256-10-4	M18x1.5	6	1/4	52	2.05	27	1.06	12
1D256-10-5	M18x1.5	8	5/16	53	2.09	27	1.06	14
1D256-12-5	M20x1.5	8	5/16	53	2.09	27	1.06	17
1D256-12-6	M20x1.5	10	3/8	53	2.09	27	1.06	19
1D256-14-6	M22x1.5	10	3/8	57	2.24	31	1.22	17
1D256-16-6	M24x1.5	10	3/8	57	2.24	31	1.22	19
1D256-16-8	M24x1.5	13	1/2	60	2.36	31	1.22	22
1D256-20-12	M30x2	19	3/4	72	2.83	38	1.50	22

1D956 Male BSPP - Straight (60° Cone) ISO 228-1

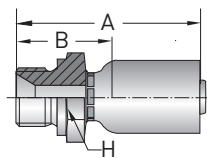

Construction: Steel. Add "C" for Stainless Steel.



Part Number	Thread Size	Hose I.D.		A		Cutoff Allow. B		H Hex
		mm	inch	mm	inch	mm	inch	mm
#								
1D956-4-3	G 1/4	5	3/16	44	1.73	27	1.06	19
1D956-4-4	G 1/4	6	1/4	52	2.05	27	1.06	19
1D956-6-5	G 3/8	8	5/16	53	2.09	27	1.06	22
1D956-6-6	G 3/8	10	3/8	53	2.09	28	1.10	22
1D956-8-8	G 1/2	13	1/2	60	2.36	32	1.26	27
1D956-12-12	G 3/4	19	3/4	75	2.95	41	1.61	32
1D956-16-16	G 1	25	1	91	3.58	42	1.65	41



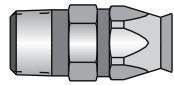

WARNING

This product can expose you to chemicals including Lead, which is known to the State of California to cause cancer and birth defects or other reproductive harm. For more information go to www.P65Warnings.ca.gov.

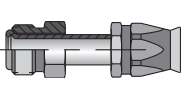
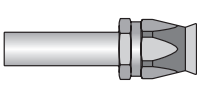
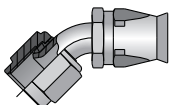
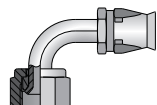
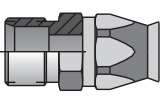
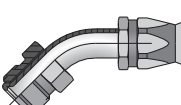
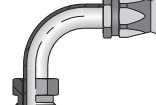
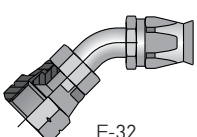
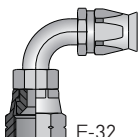
90 Series Visual Index

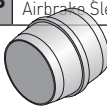
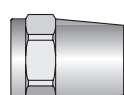

90 Series FIELD ATTACHABLE	201 Male Taper Pipe Rigid  E-29	206 SAE (JIC) 37° Swivel  E-30	208 SAE 45° Swivel  E-30	228 SAE Male Inverted Swivel Straight  E-30	234 Straight Tube  E-31
	237 JIC 37° Swivel 45° Elbow  E-31	239 JIC 37° Swivel 90° Elbow Short  E-31	261 SAE Compression Air Brake  E-31	267 SAE Male Inverted Swivel 45° Elbow  E-32	269 SAE Male Inverted Swivel 90° Elbow  E-32
	277 SAE 45° Swivel 45° Elbow  E-32	279 SAE 45° Swivel 90° Elbow  E-32			

90 Series REPLACEMENT COMPONENTS	200 Replacement Socket  E-33	090 Replacement Ferrule  E-33	60HAB SAE Compression Airbrake Sleeve  E-33	61HAB SAE Compression Airbrake Nut  E-33
--	--	---	---	--

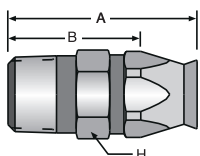
20190 Male Taper Pipe Rigid

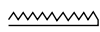

Construction: Brass nipple and ferrule, steel socket. Add "C" for Stainless Steel.

Part Number	Thread Size	Hose Size	A		Cutoff Allow. B		H Hex
			inch	mm	inch	mm	
#							
200812-4	1/8-27	-4	1.33	34	7/8	22	9/16
20190-4-4	1/4-18	-4	1.58	40	1-1/16	27	9/16
20190-4-5	1/4-18	-5	1.66	42	1-1/8	29	5/8
20190-4-6	1/4-18	-6	1.66	42	1-1/8	29	11/16
20190-6-6	3/8-18	-6	1.66	42	1-1/8	29	11/16
20190-6-8	3/8-18	-8	1.77	45	1-3/16	30	7/8
20190-8-8	1/2-14	-8	1.97	50	1-7/16	37	7/8
20190-8-10	1/2-14	-10	2.13	54	1-7/16	37	1
20190-12-12	3/4-14	-12	2.26	57	1-9/16	40	1-1/8
20190-12-16	3/4-14	-16	2.29	58	1-5/8	41	1-3/8
20190-16-16	1-11-1/2	-16	2.46	62	1-7/8	48	1-3/8
20190-20-20	1-1/4-11-1/2	-20	2.69	68	2-1/16	52	2



WARNING

This product can expose you to chemicals including Lead, which is known to the State of California to cause cancer and birth defects or other reproductive harm. For more information go to www.P65Warnings.ca.gov.

A Hose

B Tubing

C Coiled Air Hose & Fittings

D Transportation

E Fittings

F Tooling, Equipment & Accessories

G General Technical

A Hose

20690 SAE (JIC) 37° Swivel

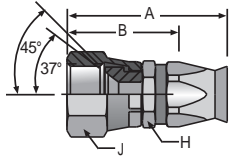

Construction: Brass nipple and ferrule, steel nut and socket.
Add "C" for Stainless Steel.

B Tubing

Part Number	Thread Size	Hose Size	A		Cutoff Allow. B		H Hex	J Hex
			inch	mm	inch	mm	inch	inch
#								
20690-4-4	7/16-20	-4	1.58	40	1-1/8	29	9/16	9/16
20690-5-5	1/2-20	-5	1.66	42	1-1/8	29	5/8	5/8
20690-6-6	9/16-18	-6	1.74	44	1-3/16	35	11/16	11/16
20690-8-6	3/4-16	-6	1.85	47	1-5/16	33	7/8	7/8
20690-8-8	3/4-16	-8	1.98	50	1-3/8	35	7/8	7/8
20690-8-10	3/4-16	-10	2.07	53	1-7/16	37	1	7/8
20690-10-10	7/8-14	-10	2.22	56	1-1/2	38	1	1
20690-12-12	1-1/16-12	-12	2.33	59	1-5/8	41	1-1/4	1-1/4
20690-16-16	1-5/16-12	-16	2.52	64	1-15/16	49	1-3/8	1-1/2
20690-20-20	1-5/8-12	-20	2.99	76	2-5/16	59	2	2

NOTE: Sizes -4, -5, -8 and -10 incorporate a dual seat.

C Coiled Air Hose & Fittings

20890 SAE 45° Swivel

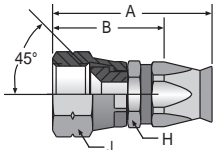

Construction: Brass nipple and ferrule, steel nut and socket.
Add "C" for Stainless Steel.

D Transportation

Part Number	Thread Size	Hose Size	A		Cutoff Allow. B		H Hex	J Hex
			inch	mm	inch	mm	inch	inch
#								
20890-6-6	5/8-18	-6	1.77	45	1-1/4	32	11/16	3/4
20890-12-12	1-1/16-14	-12	2.34	59	1-11/16	43	1-1/8	1-1/4

E Fittings

22890 SAE Male Inverted Swivel Straight

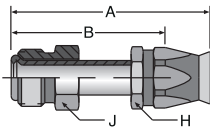

Construction: Steel nipple, nut and socket, brass ferrule.
Add "C" for Stainless Steel.

F Tooling, Equipment & Accessories

Part Number	Thread Size	Hose Size	A		Cutoff Allow. B		H Hex	J Hex
			inch	mm	inch	mm	inch	inch
#								
22890-4-4	7/16-24	-4	2.15	55	1-11/16	43	9/16	7/16
22890-5-5	1/2-20	-5	2.21	56	1-11/16	43	5/8	1/2
22890-5-6	1/2-20	-6	2.20	56	1-11/16	43	11/16	1/2
22890-6-6	5/8-18	-6	2.22	56	1-11/16	43	11/16	5/8
22890-8-8	3/4-18	-8	2.34	59	1-13/16	46	13/16	3/4
22890-10-10	7/8-18	-10	2.53	64	1-7/8	48	15/16	7/8
22890-12-12	1-1/16-16	-12	3.01	76	2-3/8	60	1-1/8	1-1/16

G General Technical

WARNING This product can expose you to chemicals including Lead, which is known to the State of California to cause cancer and birth defects or other reproductive harm. For more information go to www.P65Warnings.ca.gov.

23490 Straight Tube

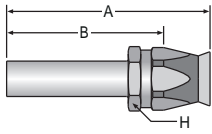

Construction: Brass nipple and ferrule, steel socket.
NOTE: 26T90 fitting includes 23490 with the 60HAB sleeve & 61HAB nut.

Part Number	Hose Size	Tube Size		A		Cutoff Allow. B		H Hex
		inch	mm	inch	mm	inch	mm	inch
#								
23490-8-8	-8	1/2	6	3.06	78	2-1/2	64	13/16
23490-8-10	-10	1/2	8	3.15	80	2-1/2	64	1
23490-10-8	-8	5/8	8	3.26	83	2-5/8	67	13/16
23490-10-10	-10	5/8	10	3.28	83	2-5/8	67	1
23490-12-12	-12	3/4	13	3.28	83	2-11/16	68	1-1/8

23790 JIC 37° Swivel 45° Elbow

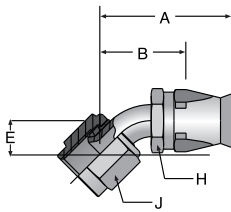

Construction: Brass ferrule, steel tube, nut and socket. Add "C" for Stainless Steel.

Part Number	Thread Size	Hose Size	A		Cutoff Allow. B		E		H Hex	J Hex
			inch	mm	inch	mm	inch	mm	inch	inch
#										
23790-4-4	7/16-20	-4	1.79	45	1-3/8	35	0.33	8	9/16	9/16
23790-5-5	1/2-20	-5	1.86	47	1-3/8	35	0.36	9	5/8	5/8
23790-6-6	9/16-18	-6	1.96	50	1-7/16	37	0.39	10	11/16	11/16
23790-8-6	3/4-16	-6	2.11	54	1-11/16	43	0.55	14	11/16	7/8
23790-8-8	3/4-16	-8	2.40	61	1-3/4	44	0.55	14	13/16	7/8
23790-10-10	7/8-14	-10	2.45	62	1-7/8	48	0.63	16	15/16	1
23790-12-12	1-1/16-12	-12	3.04	77	2-7/16	62	0.78	20	1-1/8	1-1/4
23790-16-16	1-5/16-12	-16	3.28	83	2-11/16	68	0.90	23	1-3/8	1-1/2
23790-20-20	1-5/8-12	-20	3.70	94	3-1/16	78	1.18	30	1-3/4	2

23990 JIC 37° Swivel 90° Elbow Short Drop

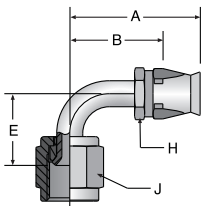

Construction: Brass ferrule, steel tube, nut and socket. Add "C" for Stainless Steel.

Part Number	Thread Size	Hose Size	A		Cutoff Allow. B		E		H Hex	J Hex
			inch	mm	inch	mm	inch	mm	inch	inch
#										
23990-4-4	7/16-20	-4	1.67	41	1-1/4	32	0.68	17	9/16	9/16
23990-5-5	1/2-20	-5	1.75	44	1-1/4	32	0.77	20	5/8	5/8
23990-6-6	9/16-18	-6	1.86	47	1-3/8	35	0.85	22	11/16	11/16
23990-8-6	3/4-16	-6	1.95	50	1-7/16	37	1.09	28	11/16	7/8
23990-8-8	3/4-16	-8	2.15	55	1-1/2	38	1.09	28	13/16	7/8
23990-10-10	7/8-14	-10	2.38	60	1-3/4	44	1.23	31	15/16	1
23990-12-12	1-1/16-12	-12	2.95	75	2-5/16	59	1.82	46	1-1/8	1-1/4
23990-16-16	1-5/16-12	-16	3.13	80	2-1/2	64	2.14	54	1-3/8	1-1/2
23990-20-20	1-5/8-12	-20	3.54	90	2-7/8	73	2.57	65	1-3/4	2

26190 SAE Compression Air Brake

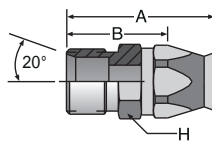

Construction: Brass nipple and ferrule, steel socket.

Part Number	Thread Size	Hose Size	A		Cutoff Allow. B		H Hex
			inch	mm	inch	mm	inch
#							
26190-8-8	11/16-20	-8	1.69	43	1-1/16	27	13/16
26190-8-10	11/16-20	-10	1.86	47	1-3/16	30	1
26190-10-10	13/16-18	-10	1.92	49	1-1/4	32	1
26190-12-10	1-18	-10	2.09	53	1-7/16	37	1
26190-12-12	1-18	-12	2.09	53	1-7/16	37	1-1/8

WARNING This product can expose you to chemicals including Lead, which is known to the State of California to cause cancer and birth defects or other reproductive harm. For more information go to www.P65Warnings.ca.gov.

A Hose

B Tubing

C Coiled Air Hose & Fittings

D Transportation

E Fittings

F Tooling, Equipment & Accessories

G General Technical

A Hose

26790 SAE Male Inverted Swivel 45° Elbow

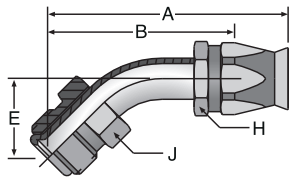

Construction: Brass ferrule, steel tube, nut and socket. Add "C" for Stainless Steel.

Part Number	Thread Size	Hose Size	A		Cutoff Allow. B		E		H Hex	J Hex
			inch	mm	inch	mm	inch	mm	inch	inch
#										
26790-4-4	7/16-24	-4	2.11	54	1-11/16	43	0.63	16	9/16	7/16
26790-5-5	1/2-20	-5	2.51	64	2	51	0.94	24	5/8	1/2
26790-5-6	1/2-20	-6	2.55	65	2-1/16	52	0.94	24	11/16	1/2
26790-6-6	5/8-18	-6	2.61	66	2-1/8	54	0.94	24	11/16	5/8
26790-8-8	3/4-18	-8	2.97	75	2-3/8	60	0.94	24	13/16	3/4
26790-8-10	3/4-18	-10	3.05	77	2-7/16	62	0.94	24	15/16	3/4
26790-10-10	7/8-18	-10	3.43	87	2-11/16	68	1.02	26	15/16	7/8
26790-12-12	1-1/16-16	-12	3.83	97	3-3/16	81	1.15	29	1-1/8	1-1/16

B Tubing

C Coiled Air Hose & Fittings

26990 SAE Male Inverted Swivel 90° Elbow

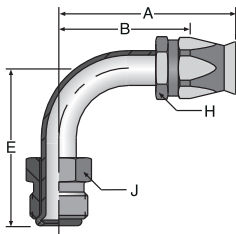

Construction: Brass ferrule, steel tube, nut and socket. Add "C" for Stainless Steel.

Part Number	Thread Size	Hose Size	A		Cutoff Allow. B		E		H Hex	J Hex
			inch	mm	inch	mm	inch	mm	inch	inch
#										
26990-4-4	7/16-24	-4	1.79	45	1-5/16	33	1.19	30	9/16	7/16
26990-5-5	1/2-20	-5	2.01	51	1-1/2	38	1.65	42	5/8	1/2
26990-5-6	1/2-20	-6	2.05	52	1-9/16	40	1.65	42	11/16	1/2
26990-6-6	5/8-18	-6	2.03	52	1-1/2	38	1.70	43	11/16	5/8
26990-8-8	3/4-18	-8	2.30	58	1-11/16	43	1.78	45	13/16	3/4
26990-8-10	3/4-18	-10	2.39	61	1-3/4	44	1.78	45	15/16	3/4
26990-10-10	7/8-18	-10	3.16	80	2-1/2	64	2.18	55	15/16	7/8
26990-12-12	1-1/16-16	-12	3.56	90	2-15/16	75	2.51	64	1-1/8	1-1/16

D Transportation

27790 SAE 45° Swivel 45° Elbow

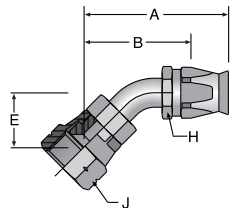

Construction: Brass ferrule, steel tube, nut and socket. Add "C" for Stainless Steel.

Part Number	Thread Size	Hose Size	A		Cutoff Allow. B		E		H Hex	J Hex
			inch	mm	inch	mm	inch	mm	inch	inch
#										
27790-6-6	5/8-18	-6	1.72	44	1-3/16	30	0.39	10	11/16	3/4
27790-12-12	1-1/16-14	-12	3.03	77	2-3/8	60	0.78	20	1-1/8	1-1/4

F Fittings

27990 SAE 45° Swivel 90° Elbow

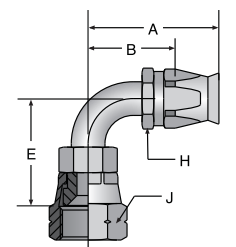

Construction: Brass ferrule, steel tube, nut and socket. Add "C" for Stainless Steel.

Part Number	Thread Size	Hose Size	A		Cutoff Allow. B		E		H Hex	J Hex
			inch	mm	inch	mm	inch	mm	inch	inch
#										
27990-6-6	5/8-18	-6	1.86	47	1-3/8	35	.85	22	11/16	3/4
27990-8-8	3/4-16	-8	2.09	53	1-1/2	38	1.09	28	13/16	7/8
27990-12-12	1-1/16-14	-12	2.95	75	2-5/16	39	1.82	46	1-1/8	1-1/4

T Tooling, Equipment & Accessories

WARNING This product can expose you to chemicals including Lead, which is known to the State of California to cause cancer and birth defects or other reproductive harm. For more information go to www.P65Warnings.ca.gov.

G General Technical

20090 Replacement Socket for Field Attachable Fittings

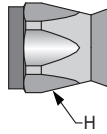

Part Number	H Hex
#	⬡
	inch
20090-4	9/16
20090-5	5/8
20090-6	11/16
20090-8	7/8
20090-10	1
20090-12	1-1/8
20090-16	1-3/8
20090-20	1-3/4

Construction: Steel or Stainless Steel.
Add "C" for Stainless Steel.

60 HAB SAE Compression Airbrake Sleeve

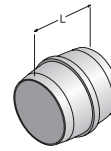

Part Number	Tube Size		L
	inch	mm	
#	⊙		
	inch	mm	inch
60HAB-4	1/4	6	.250
60HAB-6	3/8	10	.313
60HAB-8	1/2	13	.375
60HAB-10	5/8	16	.438
60HAB-12	3/4	19	.500

Construction: Brass.
NOTE: To be used with 13491N & 23490.

For reference only. Not sold as individual components

090 Replacement Ferrule for 90 Series Field Attachable Fittings

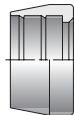

Part Number	Hose Size
#	
090-4B	-4
090-5B	-5
090-6B	-6
090-8B	-8
090-10B	-10
090-12B	-12
090-16B	-16
090-20B	-20

Construction: Brass.
Replace "B" with "C" for Stainless Steel.

61 HAB SAE Compression Airbrake Nut

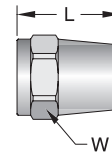

Part Number	Thread Size	Tube Size		L		W Hex
		inch	mm	inch	mm	inch
#	⌘	⊙				⬡
61HAB-4	7/16-24	1/4	6	0.75	19	9/16
61HAB-6	7/32-24	3/8	10	1.13	29	5/8
61HAB-8	11/16-20	1/2	13	1.25	32	13/16
61HAB-10	13/16-18	5/8	16	1.38	35	15/16
61HAB-12	1-18	3/4	19	1.56	40	1-1/8

Construction: Brass.
NOTE: To be used with 13491N & 23490 Fittings.

For reference only. Not sold as individual components



WARNING

This product can expose you to chemicals including Lead, which is known to the State of California to cause cancer and birth defects or other reproductive harm. For more information go to www.P65Warnings.ca.gov.

Hose
A

Tubing
B

Coiled Air Hose
& Fittings
C

Transportation
D

Fittings
E

Tooling,
Equipment
& Accessories
F

General
Technical
G

91N Series Visual Index

Hose

Tubing







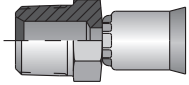
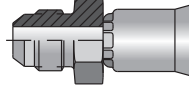
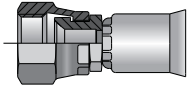
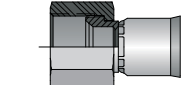
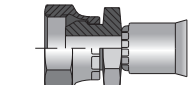
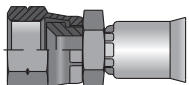
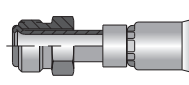
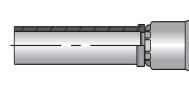
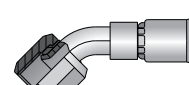
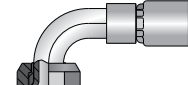
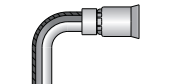
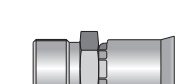

Coiled Air Hose & Fittings

Transportation

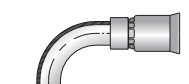
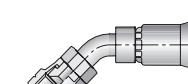
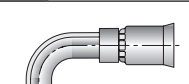
Fittings

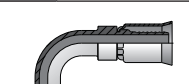
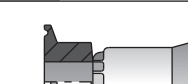
Tooling, Equipment & Accessories

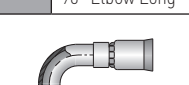
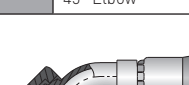
General Technical

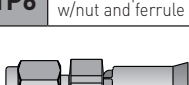
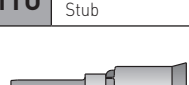
91N Series PERMANENT	101 Male Taper Pipe Rigid  E-35	103 Male JIC 37°  E-35	106 JIC 37° Female Swivel  E-35	106 RD JIC 37° Female Swivel w/o Nip. Hex  E-36	107 Female Pipe Swivel  E-36
	108 Female SAE 45° Swivel  E-36	128 Male Inverted Swivel Straight  E-36	134 Straight Tube  E-37	137 Female JIC 37° Swivel 45° Elbow  E-37	139 Female JIC 37° Swivel 90° Elbow Sht.  E-37
141 Female JIC 37° Swivel 90° Elb Long  E-38	161 Compression Air Brake  E-38	167 SAE Male Inverted 45° Elbow  E-38	169 SAE Male Inverted 90° Elbow  E-38	177 SAE 45° Swivel 90° 45° Elbow  E-39	
179 SAE 45° Swivel 90° Elbow  E-39	192 Female BSP Pipe Swivel - Str. (60° Cone)  E-42	1AL A-Lok® Compression  E-39	1B2 Female BSP Pipe Swivel 90° Elb. (37° Cone)  E-42	1FN Sanitary Flange  E-40	
1GK Bulkhead w/Zerk Port Integrated  E-42	1J1 Female Seal-Lok™ 90° Elbow Long  E-40	1J7 Female Seal-Lok™ 45° Elbow  E-40	1J9 Female Seal-Lok™ 90° Elbow  E-40	1JC Female Seal-Lok™ Swivel Straight  E-41	
1P6 CPI® Compression w/nut and ferrule  E-39	1TU Universal Tube Stub  E-41				

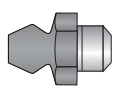
1GK91N OPTIONS	Nut 2GK-Nut  E-42	Zerk NA-6520  E-42



WARNING

This product can expose you to chemicals including Lead, which is known to the State of California to cause cancer and birth defects or other reproductive harm. For more information go to www.P65Warnings.ca.gov.

10191N Male Taper Pipe Rigid

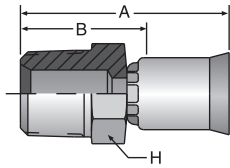

Construction: Brass nipple, steel shell. Add "C" for Stainless Steel.

Part Number	Thread Size	Hose Size	A		Cutoff Allow. B		H Hex
			inch	mm	inch	mm	inch
#							
10191N-2-4	1/8-27	-4	1.27	32	3/4	19	7/16
10191N-4-4	1/4-18	-4	1.50	38	15/16	24	9/16
10191N-4-5	1/4-18	-5	1.55	39	15/16	24	9/16
10191N-4-6	1/4-18	-6	1.60	41	15/16	24	9/16
10191N-6-6	3/8-18	-6	1.65	58	1	25	11/16
10191N-6-8	3/8-18	-8	1.71	43	1	25	11/16
10191N-8-8	1/2-14	-8	1.94	49	1-1/4	32	7/8
10191N-8-10	1/2-14	-10	1.96	50	1-1/4	32	7/8
10191N-8-12	1/2-14	-12	2.42	61	1-1/4	32	1
10191N-12-12	3/4-14	-12	2.19	56	1-3/8	35	1-1/8
10191N-16-16	1-11-1/2	-16	2.46	62	1-1/2	38	1-3/8
10191-20-20	1-1/4-11-1/2	-20	3.05	77	2-1/16	52	1-3/4

10391N Male (JIC) 37°

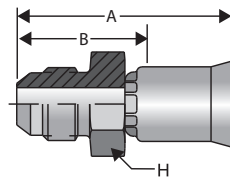

Construction: Steel nipple, steel shell. Add "C" for Stainless Steel.

Part Number	Thread Size	Hose Size	A		Cutoff Allow. B		H Hex
			inch	mm	inch	mm	inch
#							
10391N-4-4	7/16-20	-4	1.37	35	13/16	21	1/2
10391N-6-6	9/16-18	-6	1.64	42	1	25	11/16
10391N-8-8	3/4-16	-8	1.79	35	1-1/8	29	7/8
10391N-8-6	3/4-16	-6	1.73	44	1-1/16	27	7/8
10391N-10-10	7/8-14	-10	2.07	53	1-3/8	35	1
10391N-12-12	1-1/16-12	-12	2.10	53	1-5/16	33	1-1/8
10391N-16-16	1-5/16-12	-16	2.43	62	1-1/2	38	1-3/8

10691N Female SAE (JIC) 37° Swivel

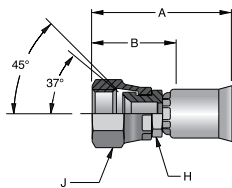

Construction: Brass nipple, steel nut and shell. Add "S" for Steel nipple, nut and shell. Add "C" for Stainless Steel. Add "B" for Brass. Some sizes may not be available in every material. Contact Customer Service.

Part Number	Thread Size	Hose Size	A		Cutoff Allow. B		H Hex	J Hex
			inch	mm	inch	mm	inch	inch
#								
10691N-4-4	7/16-20	-4	1.47	37	7/8	22	3/8	9/16
10691N-5-5	1/2-20	-5	1.60	41	1	25	7/16	5/8
10691N-6-6	9/16-18	-6	1.66	42	1	25	1/2	11/16
10691N-6-8	9/16-18	-8	1.72	44	1	25	9/16	11/16
10691N-8-8	3/4-16	-8	1.89	48	1-3/16	30	11/16	7/8
10691N-8-10	3/4-16	-10	1.86	58	1-1/8	29	3/4	7/8
10691N-10-10	7/8-14	-10	2.03	52	1-5/16	33	13/16	1
10691N-12-12	1-1/16-12	-12	2.18	55	1-3/8	35	1	1-1/4
10691N-16-16	1-5/16-12	-16	2.45	62	1-9/16	40	1-1/4	1-1/2
10691-20-20	1-5/8-12	-20	2.66	68	1-5/8	42	1-11/16	2

NOTE: Sizes -4, -5, -8 and -10 Incorporate a dual seat.



WARNING

This product can expose you to chemicals including Lead, which is known to the State of California to cause cancer and birth defects or other reproductive harm. For more information go to www.P65Warnings.ca.gov.

Hose A

Tubing B

Coiled Air Hose C & Fittings

Transportation D

Fittings E

Tooling, Equipment & Accessories F

General Technical G

A Hose

10691NRD SAE (JIC) 37° Swivel

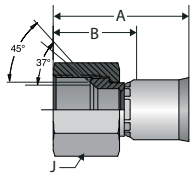

Construction: Brass nipple, steel nut and shell. Add "C" for Stainless Steel.

Part Number	Thread Size	Hose Size	A		Cutoff Allow. B		J Hex
			inch	mm	inch	mm	inch
#							
10691N-4-4-RD	7/16-20	-4	1.34	34	13/16	21	9/16
10691N-5-5-RD	1/2-20	-5	1.52	39	15/16	24	5/8
10691N-6-6-RD	9/16-18	-6	1.61	41	1	25	11/16
10691N-8-8-RD	3/4-16	-8	1.77	45	1-1/16	27	7/8
10691N-10-10-RD	7/8-14	-10	1.91	49	1-3/16	30	1
10691N-12-12-RD	1-1/16-12	-12	2.09	52	1-5/16	33	1-1/4
10691N-16-16-RD	1-5/16-12	-16	2.30	58	1-3/8	35	1-1/2

NOTE: Sizes -4, -5, -8 and -10 Incorporate a dual seat..

B Tubing

C Coiled Air Hose & Fittings

10791N Female Pipe Swivel

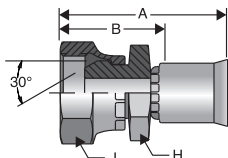

Construction: Brass nipple, steel nut and shell. Add "C" for Stainless Steel.

Part Number	Thread Size	Hose Size	A		Cutoff Allow. B		H Hex	J Hex
			inch	mm	inch	mm	inch	inch
#								
10791N-4-4	1/4-18	-4	1.54	39	1	25	9/16	11/16
10791N-6-6	3/8-18	-6	1.59	40	15/16	24	5/8	7/8
10791N-8-8	1/2-14	-8	1.83	46	1-1/8	29	3/4	1
10791N-12-12	3/4-14	-12	2.09	53	1-5/16	33	1	1-1/4
10791N-16-16	1-11-1/2	-16	2.35	59	1-7/16	33	1-3/16	1-1/2

D Transportation

10891N SAE 45° Swivel

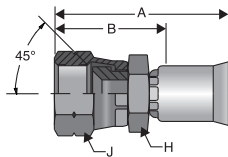

Construction: Brass nipple, steel nut and shell. Add "C" for Stainless Steel.

Part Number	Thread Size	Hose Size	A		Cutoff Allow. B		H Hex	J Hex
			inch	mm	inch	mm	inch	inch
#								
10891N-6-6	5/8-18	-6	1.74	44	1-1/8	29	5/8	3/4
10891N-12-12	1-1/16-14	-12	2.18	55	1-3/8	35	1	1-1/4

E Fittings

12891N Male Inverted Swivel–Straight

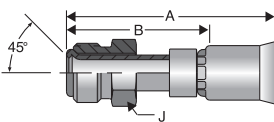

Construction: Steel nipple, tube, nut and shell. Add "C" for Stainless Steel.

Part Number	Thread Size	Hose Size	A		Cutoff Allow. B		J Hex
			inch	mm	inch	mm	inch
#							
12891N-4-4	7/16-24	-4	2.09	53	1-1/2	38	7/16
12891N-5-5	1/2-20	-5	2.15	55	1-9/16	40	1/2
12891N-5-6	1/2-20	-6	2.23	57	1-9/16	40	1/2
12891N-6-6	5/8-18	-6	2.23	57	1-9/16	40	5/8
12891N-8-8	3/4-18	-8	2.31	59	1-5/8	41	3/4
12891N-10-10	7/8-18	-10	2.43	58	1-3/4	44	7/8
12891N-12-12	1-1/16-16	-12	2.50	64	1-11/16	43	1-1/16

F Tooling, Equipment & Accessories

WARNING This product can expose you to chemicals including Lead, which is known to the State of California to cause cancer and birth defects or other reproductive harm. For more information go to www.P65Warnings.ca.gov.

G General Technical

13491N Straight Tube

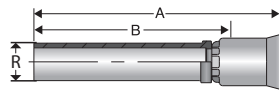

Construction: Brass nipple, steel shell.

Part Number	Hose Size	Diameter R	A		Cutoff Allow. B	
			inch	mm	inch	mm
#						
13491N-8-8	-8	1/2	2.80	71	2-1/8	54
13491N-8-10	-10	1/2	2.81	71	2-1/8	54
13491N-10-10	-10	5/8	2.96	75	2-1/4	58
13491N-12-12	-12	3/4	3.37	86	2-9/16	65

NOTE: The 16T91N fitting includes 13491N with the 60HAB sleeve and 61HAB nut.

13791N JIC 37° Swivel 45° Elbow

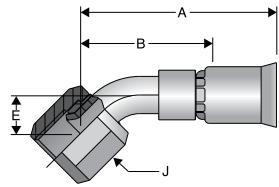

Construction: Steel nipple, tube, nut and shell. Add "C" for Stainless Steel.

Part Number	Thread Size	Hose Size	A		Cutoff Allow. B		E		J Hex
			inch	mm	inch	mm	inch	mm	inch
#									
13791N-4-4	7/16-20	-4	1.74	44	1-3/16	30	0.33	8	9/16
13791N-5-5	1/2-20	-5	1.87	47	1-1/4	32	0.36	9	5/8
13791N-6-6	9/16-18	-6	1.94	49	1-5/16	33	0.43	11	11/16
13791N-8-8	3/4-16	-8	2.28	58	1-9/16	37	0.55	14	7/8
13791N-10-10	7/8-14	-10	2.42	61	1-11/16	43	0.64	43	1
13791N-12-12	1-1/16-12	-12	2.83	58	2-1/16	52	0.78	20	1-1/4
13791N-16-16	1-5/16-12	-16	3.18	81	2-1/4	57	0.89	23	1-1/2
13791-20-20	1-5/8-12	-20	3.67	93	2-9/16	65	1.10	28	2

13991N JIC 37° Swivel 90° Elbow Short Drop

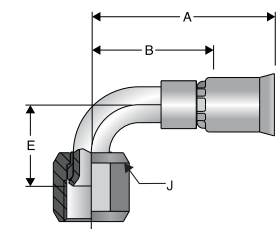

Construction: Steel nipple, tube, nut and shell. Add "C" for Stainless Steel.

Part Number	Thread Size	Hose Size	A		Cutoff Allow. B		E		J Hex
			inch	mm	inch	mm	inch	mm	inch
#									
13991N-4-4	7/16-20	-4	1.62	41	1-1/16	37	0.68	17	9/16
13991N-5-5	1/2-20	-5	1.73	44	1-1/8	29	0.77	20	5/8
13991N-6-6	9/16-18	-6	1.91	49	1-1/4	32	0.91	23	11/16
13991N-8-8	3/4-16	-8	2.03	52	1-5/16	33	1.09	28	7/8
13991N-10-10	7/8-14	-10	2.27	58	1-9/16	37	1.23	43	1
13991N-12-12	1-1/16-12	-12	2.75	58	1-15/16	49	1.82	46	1-1/2
13991N-16-16	1-5/16-12	-16	3.15	80	2-3/16	56	2.14	52	1-1/2
13991-20-20	1-5/8-12	-20	3.53	90	2-7/16	62	1.18	30	2



WARNING

This product can expose you to chemicals including Lead, which is known to the State of California to cause cancer and birth defects or other reproductive harm. For more information go to www.P65Warnings.ca.gov.

A Hose

14191N JIC 37° Swivel 90° Elbow Long Drop

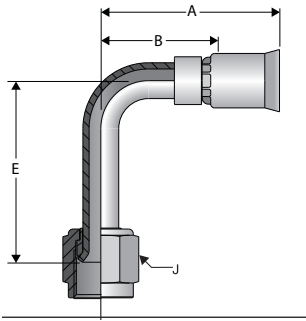

Construction: Steel nipple, tube, nut and shell. Add "C" for Stainless Steel.

Part Number	Thread Size	Hose Size	A		Cutoff Allow. B		E		J Hex
			inch	mm	inch	mm	inch	mm	inch
#									
14191N-4-4	7/16-20	-4	1.66	42	1-1/8	29	1.80	46	9/16
14191N-5-5	1/2-20	-5	1.72	44	1-1/8	29	1.77	45	5/8
14191N-6-6	9/16-18	-6	1.93	49	1-5/16	33	2.13	54	11/16
14191N-8-8	3/4-16	-8	2.11	54	1-3/8	35	2.52	64	7/8
14191N-10-10	7/8-14	-10	2.34	59	1-5/8	41	2.57	65	1
14191N-12-12	1-1/16-12	-12	2.63	67	1-7/8	48	3.73	95	1-1/4
14191N-16-16	1-5/16-12	-16	3.15	80	2-3/16	56	4.33	110	1-1/2
14191-20-20	1-5/8-12	-20	4.00	102	2-15/16	75	5.28	134	2

B Tubing

C Coiled Air Hose & Fittings

16191N Compression Air Brake

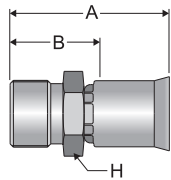

Construction: Brass nipple, steel shell.

Part Number	Thread Size	Hose Size	A		Cutoff Allow. B		H Hex
			inch	mm	inch	mm	inch
#							
16191N-8-8	11/16-20	-8	1.61	41	15/16	24	3/4
16191N-8-10	11/16-20	-10	1.61	41	15/16	24	7/8
16191N-10-10	13/16-18	-10	1.82	46	1-1/8	29	15/16
16191N-12-12	1-18	-12	1.93	49	1-1/8	29	1-1/4

D Transportation

16791N Male Inverted Swivel 45° Elbow

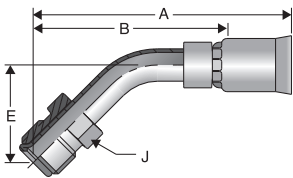

Construction: Steel nipple, tube, nut and shell. Add "C" for Stainless Steel.

Part Number	Thread Size	Hose Size	A		Cutoff Allow. B		E		J Hex
			inch	mm	inch	mm	inch	mm	inch
#									
16791N-4-4	7/16-24	-4	2.05	52	1-1/2	38	0.63	16	7/16
16791N-5-5	1/2-20	-5	2.48	63	1-7/8	48	0.71	18	1/2
16791N-6-6	5/8-18	-6	2.60	66	1-15/16	49	0.96	24	5/8
16791N-8-8	3/4-18	-8	2.85	72	2-1/8	54	0.90	23	3/4
16791N-10-10	7/8-18	-10	3.30	84	2-5/8	67	1.02	43	7/8
16791N-12-12	1-1/16-16	-12	3.64	58	2-13/16	71	1.15	29	1-1/16

E Fittings

16991N Male Inverted Swivel 90° Elbow

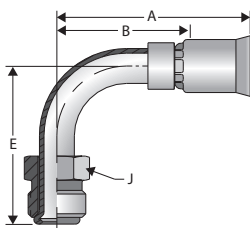

Construction: Steel nipple, tube, nut and shell. Add "C" for Stainless Steel.

Part Number	Thread Size	Hose Size	A		Cutoff Allow. B		E		J Hex
			inch	mm	inch	mm	inch	mm	inch
#									
16991N-4-4	7/16-24	-4	1.72	44	1-3/16	30	1.19	30	7/16
16991N-5-5	1/2-20	-5	1.98	50	1-3/8	35	1.65	42	1/2
16991N-5-6	1/2-20	-6	2.03	52	1-7/16	37	1.65	42	1/2
16991N-6-6	5/8-18	-6	2.08	53	1-7/16	37	1.70	43	5/8
16991N-8-8	3/4-18	-8	2.18	55	1-1/2	38	1.87	43	3/4
16991N-10-10	7/8-18	-10	3.02	58	2-5/16	59	2.18	55	7/8
16991N-12-12	1-1/16-16	-12	3.36	85	2-9/16	64	2.51	64	1-1/16

F Tooling, Equipment & Accessories

G General Technical

WARNING This product can expose you to chemicals including Lead, which is known to the State of California to cause cancer and birth defects or other reproductive harm. For more information go to www.P65Warnings.ca.gov.

17791N SAE 45° Swivel 45° Elbow

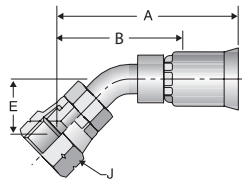

Construction: Steel nipple, tube, nut and shell. Add "C" for Stainless Steel.

Part Number	Thread Size	Hose Size	A		Cutoff Allow. B		E		J Hex
			inch	mm	inch	mm	inch	mm	inch
#									
17791N-6-6	5/8-18	3/8	2.06	52	1-5/16	33	0.39	10	3/4
17791N-12-12	1-1/16-14	3/4	3.07	78	2-7/16	62	0.78	20	1-1/4

17991N SAE 45° Swivel 90° Elbow

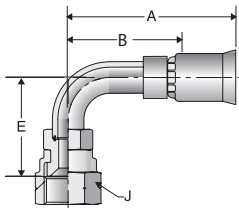

Construction: Steel nipple, tube, nut and shell. Add "C" for Stainless Steel.

Part Number	Thread Size	Hose Size	A		Cutoff Allow. B		E		J Hex
			inch	mm	inch	mm	inch	mm	inch
#									
17991N-6-6	5/8-18	3/8	2.06	52	1-5/16	49	1.19	30	3/4
17991N-12-12	1-1/16-14	3/4	2.92	74	2-1/8	54	1.82	46	1-1/4

1AL91N A-LOK® Compression

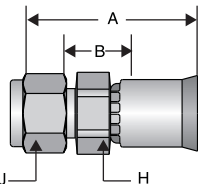

Construction: Stainless steel nipple and shell.

Part Number	Thread Size	Hose Size	A		Cutoff Allow. B		H Hex	J Hex
			inch	mm	inch	mm	inch	inch
#								
w/nut & ferrule	w/o nut & ferrules							
1AL91N-4-4C	1AL91N-4-4NC	-4	1.28	33	7/16	11	1/2	9/16
1AL91N-4-5C	1AL91N-4-5NC	-5	1.36	35	7/16	11	1/2	9/16
1AL91N-6-6C	1AL91N-6-6NC	-6	1.46	37	7/16	11	3/4	11/16
1AL91N-8-8C	1AL91N-8-8NC	-8	1.61	41	7/16	11	13/16	7/8
1AL91N-12-12C	1AL91N-12-12NC	-12	1.86	47	1/2	13	1-1/8	1-1/8
1AL91N-16-16C	1AL91N-16-16NC	-16	2.12	54	7/16	11	1-3/8	1-1/2

NOTE: Nuts and Ferrules are Manufactured by the Instrumentation Products Division. Refer to Catalog 4230/4233 for information.

Nut part No. is XNUX-316. Front ferrule part No. is XFFX-316.
Back ferrule part No. is XBFX-316. X denotes dash size.

1P691N CPI® Compression (With Nut and Ferrule)

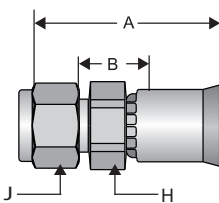

Construction: Stainless steel nipple and shell.

Part Number	Hose Size	A		Cutoff Allow. B		H Hex	J Hex
		inch	mm	inch	mm	inch	inch
#							
w/nut & ferrules							
1P691N-4-4C	-4	1.30	33	7/16	11	1/2	9/16
1P691N-6-6C	-6	1.53	39	1/2	13	5/8	11/16
1P691N-8-8C	-8	1.61	41	7/16	11	13/16	7/8

NOTE: Nuts and Ferrules are Manufactured by the Instrumentation Products Division. Refer to Catalog 4230/4233 for information.

Nut part No. is **XBZ-SS**. Ferrule part No. is **XTZ-SS**.
X denotes dash size



WARNING

This product can expose you to chemicals including Lead, which is known to the State of California to cause cancer and birth defects or other reproductive harm. For more information go to www.P65Warnings.ca.gov.

Hose A

Tubing B

Coiled Air Hose C & Fittings

Transportation D

Fittings E

Tooling, Equipment & Accessories F

General Technical G

A Hose

1FN91N Sanitary Flange

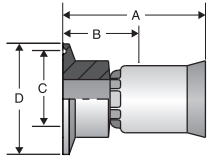

Part Number	Hose Size	A		Cutoff Allow. B		C		Flange Size D	
		inch	mm	inch	mm	inch	mm	inch	mm
#									
1FN91N-16-16C	-16	1.96	50	1-1/16	27	0.87	22	1.98	50

Construction: Stainless steel nipple and shell.

B Tubing

C Coiled Air Hose & Fittings

1J191N Female Seal-Lok™ Swivel 90° Elbow Long Drop

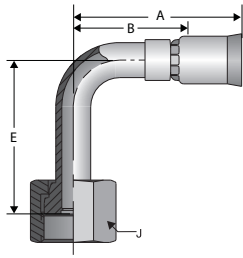

Part Number	Thread Size	Hose Size	A		Cutoff Allow. B		E		J Hex
			inch	mm	inch	mm	inch	mm	inch
#									
1J191N-4-4	9/16-18	-4	1.66	42	1-1/16	27	1.80	46	11/16
1J191N-4-5	9/16-18	-5	1.78	45	1-1/16	27	1.80	46	11/16
1J191N-6-5	11/16-16	-5	1.92	49	1-3/16	30	2.13	54	13/16
1J191N-6-6	11/16-16	-6	1.92	49	1-3/16	30	2.13	54	13/16
1J191N-8-6	13/16-16	-6	2.00	51	1-9/16	40	2.51	43	15/16
1J191N-8-8	13/16-16	-8	2.15	58	1-7/16	37	2.51	64	15/16
1J191N-10-10	1-14	-10	1.25	32	1-9/16	40	2.76	70	1-1/8
1J191N-12-12	1-3/16-12	-12	2.65	67	1-13/16	46	3.78	96	1-3/8
1J191N-16-16	1-7/16-12	-16	3.15	80	2-1/4	57	4.50	114	1-1/2

Construction: Steel nipple, tube, nut and shell. Add "C" for Stainless Steel.

D Transportation

E Fittings

1J791N Female Seal-Lok™ Swivel 45° Elbow

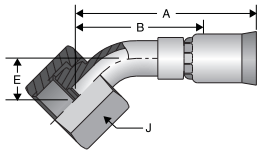

Part Number	Thread Size	Hose Size	A		Cutoff Allow. B		E		J Hex
			inch	mm	inch	mm	inch	mm	inch
#									
1J791N-4-4	9/16-18	-4	1.73	44	1-1/4	32	0.41	10	11/16
1J791N-4-6	9/16-18	-6	1.91	49	1-5/16	33	0.41	10	11/16
1J791N-6-6	11/16-16	-6	2.02	51	1-3/8	35	0.43	11	13/16
1J791N-8-8	13/16-16	-8	2.18	55	1-1/2	38	0.59	15	15/16
1J791N-8-10	13/16-16	-8	2.39	61	1-11/16	43	0.59	15	15/16
1J791N-10-10	1-14	-10	2.47	63	1-3/4	44	0.59	43	1-1/8
1J791N-12-12	1-3/16-12	-12	2.74	58	1-15/16	49	0.81	21	1-3/8
1J791N-16-16	1-7/16-12	-16	3.50	89	2-1/2	64	0.94	24	1-5/8

Construction: Steel nipple, tube, nut and shell. Add "C" for Stainless Steel.

F Tooling, Equipment & Accessories

G General Technical

WARNING This product can expose you to chemicals including Lead, which is known to the State of California to cause cancer and birth defects or other reproductive harm. For more information go to www.P65Warnings.ca.gov.

1J991N Female Seal-Lok™ Swivel 90° Elbow Short Drop

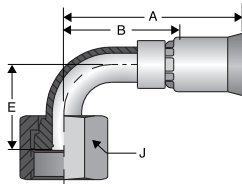

Construction: Steel nipple, tube, nut and shell. Add "C" for Stainless Steel.

Part Number	Thread Size	Hose Size	A		Cutoff Allow. B		E		J Hex
			inch	mm	inch	mm	inch	mm	inch
#									
1J991N-4-4	9/16-18	-4	1.73	44	1-1/4	32	0.82	21	11/16
1J991N-6-6	11/16-16	-6	1.91	49	1-5/16	33	0.91	23	13/16
1J991N-8-8	13/16-16	-6	2.02	51	1-3/8	35	1.15	29	15/16
1J991N-10-10	1-14	-10	2.18	55	1-1/2	38	1.27	32	1-1/8
1J991N-12-12	1-3/16-12	-12	2.39	61	1-11/16	43	1.85	43	1-3/8
1J991N-16-16	1-7/16-12	-16	2.47	63	1-3/4	44	2.21	56	1-5/8

1JC91N Female Seal-Lok™ Swivel Straight

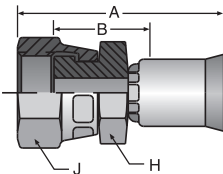

Construction: Steel nipple, steel nut and shell. Add "C" for Stainless Steel.

Part Number	Thread Size	Hose Size	A		Cutoff Allow. B		C		H Hex	J Hex
			inch	mm	inch	mm	inch	mm	inch	inch
#										
1JC91N-4-4	9/16-18	-4	1.46	37	5/8	16	.32	8	9/16	11/16
1JC91N-6-6	11/16-16	-6	1.62	41	11/16	17	.32	8	5/8	13/16
1JC91N-8-8	13/16-16	-8	1.93	49	13/16	21	.43	11	3/4	15/16
1JC91N-10-10	1-14	-10	2.05	52	7/8	22	.53	13	15/16	1-1/8
1JC91N-12-10	1-3/16-12	-10	2.05	52	1-1/4	32	.57	14	15/16	1-3/8
1JC91N-12-12	1-3/16-12	-12	2.05	58	1-1/4	32	.57	14	15/16	1-3/8
1JC91N-16-16	1-7/16-12	-16	2.56	65	1-1/16	27	.58	15	1-3/8	1-5/8
1JC91N-20-16	1-11/16-12	-16	2.30	58	1-3/8	35	.59	15	1-5/8	1-7/8
1JC91-20-20	1-11/16-12	-20	2.68	68	1-11/16	43	.59	15	1-11/16	1-7/8

1TU91N Universal Tube Stub

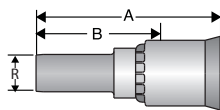

Construction: Stainless Steel.

Part Number	Thread Size	Hose Size	Diameter R	A		Cutoff Allow. B	
				inch	mm	inch	mm
#							
1TU91N-4-4C	-4	1/4	1/4	1.63	41	1-1/16	27
1TU91N-4-5C	-5	1/4	1/4	1.70	43	1-1/16	27
1TU91N-6-6C	-6	3/8	3/8	1.81	46	1-3/16	30
1TU91N-8-8C	-8	1/2	1/2	2.72	58	1-7/16	37
1TU91N-8-10C	-10	1/2	1/2	2.14	54	1-7/16	37
1TU91N-10-10C	-10	5/8	5/8	2.14	54	1-7/16	37
1TU91N-12-12C	-12	3/4	3/4	2.24	57	1-7/16	37
1TU91N-16-16C	-16	1	1	2.73	69	1-3/4	44

NOTE: Use with A-Lok & CPI nuts, sleeves and adapters. These components are manufactured by Parker's Instrumentation Connectors Division. Refer to catalog 4230/4233 for information.

WARNING This product can expose you to chemicals including Lead, which is known to the State of California to cause cancer and birth defects or other reproductive harm. For more information go to www.P65Warnings.ca.gov.

A Hose

B Tubing

C Coiled Air Hose & Fittings

D Transportation

E Fittings

F Tooling, Equipment & Accessories

G General Technical

A Hose

19291N Female BSP Parallel Pipe Swivel Straight (60° Cone)

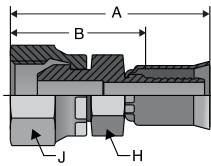

Part Number	Thread Size	Hose Size	A		Cutoff Allow. B		H Hex	J Hex
			inch	mm	inch	mm	inch	inch
#								
19291N-8-8	PF-1/2-14	-8	1.99	51	1-5/16	33	27	27
19291N-12-12	PF-3/4-14	-12	2.35	60	1-9/16	40	36	36

Construction: Steel nipple, nut and shell. Add "C" for Stainless Steel.

B Tubing

C Coiled Air Hose & Fittings

1B291N Female BSP Parallel Pipe Swivel - 90° Elbow (60° Cone)

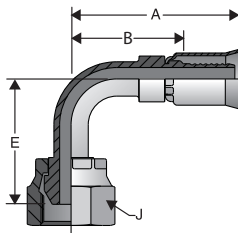

Part Number	Thread Size	Hose Size	A		Cutoff Allow. B		E		J Hex
			inch	mm	inch	mm	inch	mm	inch
#									
1B291N-8-8	PF-1/2-14	-8	2.04	52	1-3/8	35	1.57	40	27
1B291N-12-12	PF-3/4-14	-12	2.93	74	2-1/8	54	2.54	65	36

Construction: Steel nipple, nut and shell. Add "C" for Stainless Steel.

D Transportation

E Fittings

1GK91N Bulkhead with Integrated Zerk Port - Bulkhead Nut and Grease Zerk

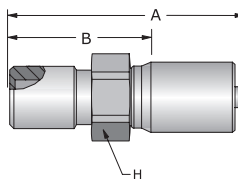

Part Number	Thread Size	Hose Size	A		Cutoff Allow. B		H Hex	
			inch	mm	inch	mm	inch	
#								
1GK91N-2-4*	1/8-27 NPSM Male with 1/4-28 UNF Female	3/16	5	1.46	37	15/16	24	1/2

Construction: Steel nipple, nut and shell. Add "C" for Stainless Steel.

NOTE: *Long bulkhead for use with plates under 3/4" thick. Uses 2GK-NUT, sold separately.

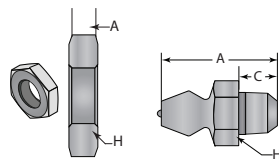

2GK-Nut

NA-6520

Part Number	Description	Thread Size	A		C		H Hex
2GK-Nut	Bulkhead Nut	1/8-27 NPSM	0.188	4.8	na	na	11/16
NA-6520	Grease Zerk Fitting	1/4-28 UNF	0.540	13.7	0.18	4.6	5/16

F Tooling, Equipment & Accessories



WARNING

This product can expose you to chemicals including Lead, which is known to the State of California to cause cancer and birth defects or other reproductive harm. For more information go to www.P65Warnings.ca.gov.

G General Technical

92 Series Visual Index

A Hose

B Tubing

C Coiled Air Hose & Fittings

D Transportation

E Fittings

F Tooling, Equipment & Accessories

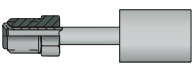
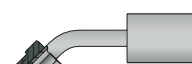
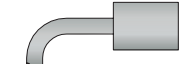

G General Technical

92 Series PERMANENT	128 SAE Male Inverted Swivel Straight	167 SAE Male Inverted 45° Elbow	169 SAE Male Inverted 90° Elbow
	 E-43	 E-43	 E-43

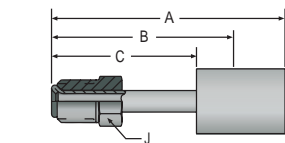
12892 SAE Male Inverted Swivel Straight





Construction: Stainless Steel.

Part Number	Thread Size	Hose Size		A		Cutoff Allow. B		C		J Hex
		inch	mm	inch	mm	inch	mm	inch	mm	inch
#										
12892-3-3C	3/8-24	3/16	5	2.01	55	1-1/2	38	1.25	32	7/16

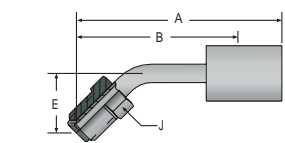
16792 SAE Male Inverted Swivel 45° Elbow





Construction: Stainless Steel.

Part Number	Thread Size	Hose Size		A		Cutoff Allow. B		E		J Hex
		inch	mm	inch	mm	inch	mm	inch	mm	inch
#										
16792-3-3C	3/8-24	3/16	5	2.36	60	1-15/16	50	0.62	16	3/8

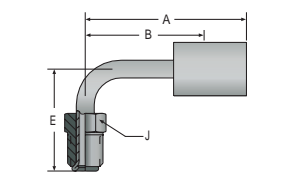
16992 SAE Male Inverted Swivel 90° Elbow



Construction: Stainless Steel.

Part Number	Thread Size	Hose Size		A		Cutoff Allow. B		E		J Hex
		inch	mm	inch	mm	inch	mm	inch	mm	inch
#										
16992-3-3C	3/8-24	3/16	5	1.45	37	1	25	1.25	32	3/8

WARNING  This product can expose you to chemicals including Lead, which is known to the State of California to cause cancer and birth defects or other reproductive harm. For more information go to www.P65Warnings.ca.gov.

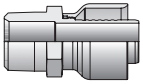
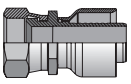
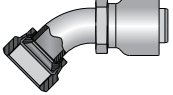
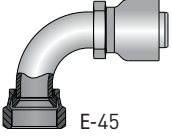
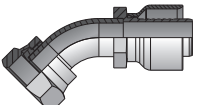
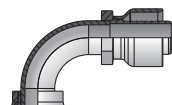
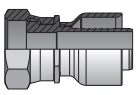

93N Series Visual Index

93N Series PERMANENT	101 Male Taper Pipe Rigid	106 Female JIC 37° Swivel	137 Female JIC 37° Swivel 45° Elbow	139 Female JIC 37° Swivel 90° Elbow Sht.
				
	E-44	E-45	E-45	E-45
	1J7 Female Seal-Lok™ 45° Elbow	1J9 Female Seal-Lok™ 90° Elbow Short	1JC Female Seal-Lok™ Swivel Straight Short	
				
	E-46	E-46	E-46	

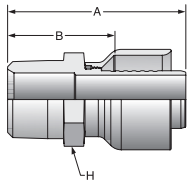
10193N Male Taper Pipe Rigid



Construction: Steel nipple, nut and shell. Add "C" for Stainless Steel.

Part Number	Thread Size	Hose Size		A		Cutoff Allow. B		H Hex
		inch	mm	inch	mm	inch	mm	inch
#								
10193N-8-8	1/2-14	1/2	13	2.09	53	1-1/2	38	7/8
10193N-12-12	3/4-14	3/4	19	2.70	69	1-5/8	41	1-1/8
10193N-16-16	1-11-1/2	1	25	3.03	77	1-13/16	46	1-3/8
10193N-20-20	1-1/4-11-1/2	1-1/4	32	3.20	58	1-7/8	48	1-11/16
10193N-24-24	1-1/2-11-1/2	1-1/2	38	3.76	96	2-1/16	52	2
10193N-32-32	2-11-1/2	2	51	3.97	101	2-5/16	59	2-1/2

WARNING This product can expose you to chemicals including Lead, which is known to the State of California to cause cancer and birth defects or other reproductive harm. For more information go to www.P65Warnings.ca.gov.

10693N (JIC) 37° Female Swivel

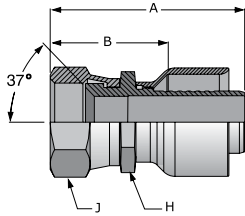

Construction: Steel nipple, nut and shell. Add "C" for Stainless Steel.

Part Number	Thread Size	Hose Size		A		Cutoff Allow. B		H Hex	J Hex
		inch	mm	inch	mm	inch	mm	inch	inch
#									
10693N-6-6	9/16-18	3/8	10	1.69	43	1-3/32	28	3/4	11/16
10693N-8-8	3/4-16	1/2	13	2.02	51	1-3/8	35	7/8	7/8
10693N-10-10	7/8-14	5/8	16	2.51	64	1-11/16	43	1	1
10693N-12-12	1-1/16-12	3/4	19	2.86	73	1-3/4	44	1-1/8	1-1/4
10693N-16-16	1-5/16-12	1	25	3.11	79	1-13/16	46	1-3/8	1-1/2
10693N-20-20	1-5/8-12	1-1/4	32	3.28	83	2	51	1-3/4	2
10693N-24-24	1-7/8-12	1-1/2	38	3.92	58	2-1/4	57	2	2-1/4
10693N-32-32	2-1/2-12	2	51	4.12	105	2-7/16	62	2-1/2	2-7/8

13793N JIC 37° Swivel 45° Elbow

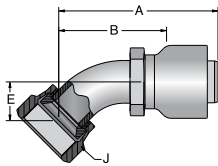

Construction: Steel nipple, nut and shell. Add "C" for Stainless Steel.

Part Number	Thread Size	Hose Size	A		Cutoff Allow. B		E		J Hex
			inch	mm	inch	mm	inch	mm	inch
#									
13793N-12-12	1-1/16-12	-12	3.37	86	2-1/4	57	.78	20	1-1/4
13793N-16-16	1-5/16-12	-16	3.71	94	2-5/8	67	.90	23	1-1/2
13793N-20-20	1-5/8-12	-20	4.06	103	2-3/4	70	1.18	43	2
13793N-24-24	1-7/8-12	-24	5.76	146	4-1/4	108	1.47	37	2-1/4

13993N JIC 37° Swivel 90° Elbow Short Drop

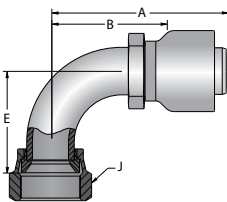

Construction: Steel nipple, nut and shell. Add "C" for Stainless Steel.

Part Number	Thread Size	Hose Size	A		Cutoff Allow. B		E		J Hex
			inch	mm	inch	mm	inch	mm	inch
#									
13993N-8-8	3/4-16	-8	2.20	56	1-9/16	40	1.09	28	7/8
13993N-10-10	7/8-14	-10	2.41	61	1-11/16	43	1.23	31	1
13993N-12-12	1-1/16-12	-12	3.28	83	2-3/16	56	1.82	46	1-1/4
13993N-16-16	1-5/16-12	-16	3.71	94	2-1/2	64	2.14	54	1-1/2
13993N-20-20	1-5/8-12	-20	3.89	99	2-9/16	65	2.57	43	2
13993N-24-24	1-7/8-12	-24	5.72	58	4-1/4	108	3.17	81	2-1/4



WARNING

This product can expose you to chemicals including Lead, which is known to the State of California to cause cancer and birth defects or other reproductive harm. For more information go to www.P65Warnings.ca.gov.

Hose A

Tubing B

Coiled Air Hose C & Fittings

Transportation D

Fittings E

Tooling, Equipment & Accessories F

General Technical G

A Hose

1JC93N Seal-Lok™ Swivel Straight Short

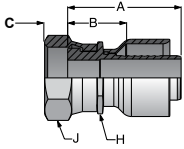

Construction: Steel nipple, nut and shell. Add "C" for Stainless Steel.

Part Number	Thread Size	Hose Size		A		Cutoff Allow. B		C		H Hex	J Hex
		inch	mm	inch	mm	inch	mm	inch	mm	inch	inch
#											
1JC93N-12-12	1-3/16-12	3/4	19	2.30	58	1-3/8	35	.57	14	1-3/8	1-3/8
1JC93N-16-16	1-7/16-12	1	25	2.61	66	1-3/8	35	.58	15	1-3/8	1-5/8
1JC93N-20-20	1-11/16-12	1-1/4	32	2.65	67	1-5/16	33	.59	15	1-7/8	1-7/8

B Tubing

C Coiled Air Hose & Fittings

1J793N Seal-Lok™ 45° Elbow

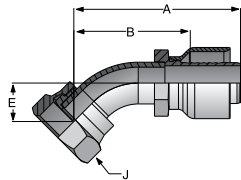

Construction: Steel nipple, nut and shell. Add "C" for Stainless Steel.

Part Number	Thread Size	Hose Size		A		Cutoff Allow. B		E		J Hex
		inch	mm	inch	mm	inch	mm	inch	mm	inch
#										
1J793N-20-20	1-11/16-12	1-1/4	32	4.25	108	2-15/16	75	1.00	25	1-7/8

NOTE: Also available in PAGE Fittings.

D Transportation

1J993N Seal-Lok™ 90° Elbow Short Drop

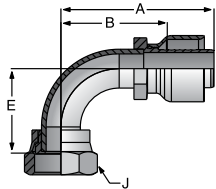

Construction: Steel nipple, nut and shell. Add "C" for Stainless Steel.

Part Number	Thread Size	Hose Size		A		Cutoff Allow. B		E		J Hex
		inch	mm	inch	mm	inch	mm	inch	mm	inch
#										
1J993N-20-20	1-11/16-12	1-1/4	32	4.36	111	3-1/16	78	2.51	64	1-7/8

NOTE: Also available in PAGE Fittings.

F Fittings

G Tooling, Equipment & Accessories

H General Technical

WARNING This product can expose you to chemicals including Lead, which is known to the State of California to cause cancer and birth defects or other reproductive harm. For more information go to www.P65Warnings.ca.gov.

94/95 Series Visual Index

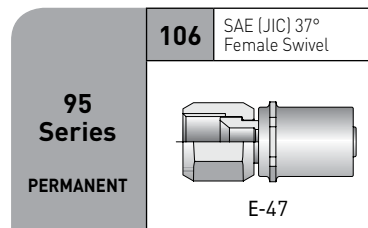
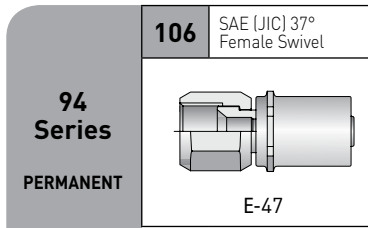

10694 SAE (JIC) 37° Female Swivel

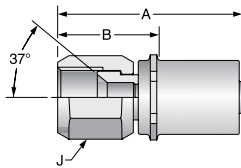

Construction: Steel nipple, nut and shell. Add "C" for Stainless Steel.

Part Number	Thread Size	Hose Size	A		Cutoff Allow. B		J Hex
			inch	mm	inch	mm	inch
#							
10694-6-6	9/16-18	-6	1.76	45	15/16	24	11/16
10694-8-8	3/4-16	-8	2.09	53	1-3/16	30	7/8
10694-10-10	7/8-14	-10	2.30	58	1-5/16	33	1
10694-12-12	1-1/16-12	-12	2.45	62	1-5/16	33	1-1/4
10694-16-16	1-5/16-12	-16	2.72	69	1-7/16	37	1-1/2

10695 SAE (JIC) 37° Female Swivel

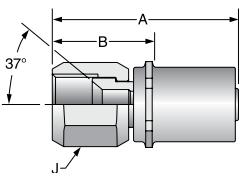

Construction: Steel nipple, nut and shell. Add "C" for Stainless Steel.

Part Number	Thread Size	Hose Size	A		Cutoff Allow. B		J Hex
			inch	mm	inch	mm	inch
#							
10695-4-4	7/16-20	-4	1.76	45	15/16	24	9/16
10695-6-6	9/16-18	-6	2.09	53	1-3/16	30	11/16
10695-8-8	3/4-16	-8	2.30	58	1-5/16	33	7/8
10695-12-12	1-1/16-12	-12	2.45	62	1-5/16	33	1-1/4
10695-16-16	1-5/16-12	-16	2.72	69	1-7/16	37	1-1/2



WARNING

This product can expose you to chemicals including Lead, which is known to the State of California to cause cancer and birth defects or other reproductive harm. For more information go to www.P65Warnings.ca.gov.

PAGE Fittings Visual Index

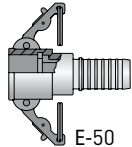
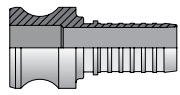
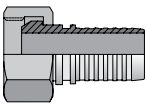
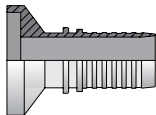
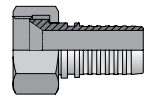
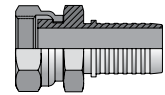
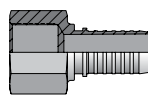
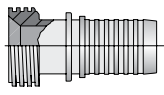
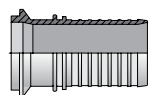
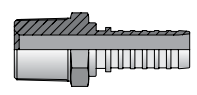
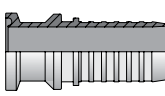
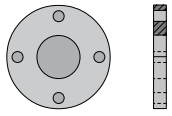
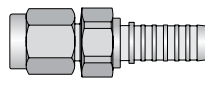
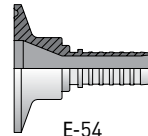
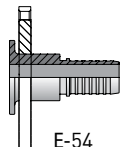
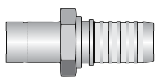
PAGE Series PERMANENT	CL Female Cam & Groove	E Male Cam & Groove	FBS Female Sanitary Bevel Seat	FIL Female I-Line® Sanitary	FJX Female JIC 37° Swivel
	 E-50	 E-50	 E-50	 E-51	 E-52
	FORFS Female Seal-Lok™ Swivel Short	FP Female NPTF Pipe Rigid	MBS Male Sanitary Bevel Seat	MIL Male I-Line® Sanitary	MP Male NPTF Pipe Rigid
	 E-52	 E-51	 E-50	 E-51	 E-52
	MSAN Mini Sanitary Flange	PF ANSI Flange	PLCF Female A-Lok® Compression	SAN Sanitary Flange & Step Downs	SFR Flange Retainer
	 E-54	 E-53	 E-53	 E-54	 E-54
	TUBE A-Lok® Male Stand pipe Rigid "V" Notch				
	 E-53				

PAGE fittings require a PAGE collar. See pg. E-49.

NOTE:
The PAGE fitting call-out does not follow traditional Parker fitting nomenclature. The end size and hose size are reversed.

 **WARNING**
This product can expose you to chemicals including Lead, which is known to the State of California to cause cancer and birth defects or other reproductive harm. For more information go to www.P65Warnings.ca.gov.

PAGE Fitting Collars - Size & Style

PAGE COLLARS	Hose	Collar # Size	04	06	08	12	16	20	24	32	40	48	64	
	STW STB	ST300	ST300	ST300	ST300	ST300	ST300	ST300	ST300	ST300				
	SCW SCB	SC300	SC300	SC300	SC300	SC300	SC300	SC300	SC300	SC300				
	SCWV SCBV	SC300			SC300	SC300	SC300	SC300	SC300	SC300	SC300	SC300	SC300	

By Size

Inserts & Collars Sold Separately

Examples:

If you need a Female JIC Swivel Fitting for a 08-SCW Hose (1/2" Convuluted), place an order for (1) 08-08 FJX-S and (1) 08-SC300.

If you need a Male Pipe Fitting for a 12-STW Hose, place an order for (1) 12-12 MP-S and (1) 12-ST300.

By Style

Size	ST300	SC300
	For use with STW/STB	For use with SCW/SCB, SCWV/SCBV
1/4"	04-ST300	04-SC300
3/8"	06-ST300	06-SC300
1/2"	08-ST300	08-SC300
3/4"	12-ST300	12-SC300
1"	16-ST300	16-SC300
1-1/4"	20Z-ST300	20-SC300
1-1/2"	24Z-ST300	24-SC300
2"	—	32-SC300
3"	—	48-SC300
4"	—	64-SC300

Construction: Stainless Steel.

NOTE: also available in carbon steel "CS".

NOTE: The PAGE fitting call-out does not follow traditional Parker fitting nomenclature. The end size and hose size are reversed.



WARNING

This product can expose you to chemicals including Lead, which is known to the State of California to cause cancer and birth defects or other reproductive harm. For more information go to www.P65Warnings.ca.gov.

A Hose

CL Female Cam & Groove

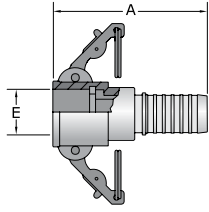

Construction: Stainless Steel.

Part Number #	Hose I.D.		A		E	
	inch	mm	inch	mm	inch	mm
16-16CL-S	1	25	4.2	107	1.44	37
24-24CL-S	1-1/2	38	5.2	132	2.10	53
32-32CL-S	2	51	6.0	152	2.48	63
48-48CL-S	3	76	7.2	183	3.60	91
64-64CL-S	4	102	7.8	198	4.70	119

NOTE: Also available as encapsulated female cam under part number TEC and TECL.

B Tubing

E Male Cam & Groove

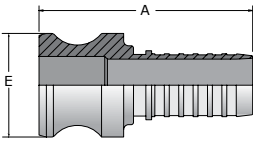

Construction: Stainless Steel.

Part Number #	Hose I.D.		A		E	
	inch	mm	inch	mm	inch	mm
12-12E-S	3/4	19	2.60	66	1.26	32
16-16E-S	1	25	2.91	74	1.44	37
20-20E-S	1-1/4	32	3.64	93	1.78	45
24-24E-S	1-1/2	38	4.03	102	2.10	53
32-32E-S	2	51	4.75	121	2.48	63
48-48E-S	3	76	5.75	146	3.60	91
64-64E-S	4	102	5.88	149	4.70	119

C Coiled Air Hose & Fittings

FBS Female Sanitary Bevel Seat

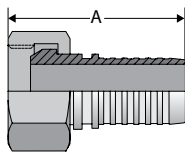

Construction: Stainless Steel.

Part Number #	Acme Thread	Hose Size		A	
		inch	mm	inch	mm
16-16FBS-S	1-1/2-8	1	25	2.74	70
24-24FBS-S	2-8	1-1/2	38	3.41	87
32-32FBS-S	2-1/2-8	2	51	3.94	100
40-40FBS-S	3-8	2-1/2	64	4.37	110
48-48FBS-S	3-1/2-8	3	76	4.85	123
64-64FBS-S	4-5/8-6	4	102	5.24	133

D Transportation

MBS Male Sanitary Bevel Seat

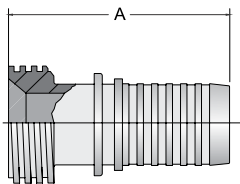

Construction: Stainless Steel.

Part Number #	Acme Thread	Hose Size		A	
		inch	mm	inch	mm
16-16MBS-S	1-1/2-8	1	25	2.74	70
24-24MBS-S	2-8	1-1/2	38	3.41	87
32-32MBS-S	2-1/2-8	2	51	3.94	100
40-40MBS-S	3-8	2-1/2	64	4.37	110
48-48MBS-S	3-1/2-8	3	76	4.85	123
64-64MBS-S	4-5/8-6	4	102	5.24	133

NOTE: The PAGE fitting call-out does not follow traditional Parker fitting nomenclature. The end size and hose size are reversed.



WARNING

This product can expose you to chemicals including Lead, which is known to the State of California to cause cancer and birth defects or other reproductive harm. For more information go to www.P65Warnings.ca.gov.

E Tooling, Equipment & Accessories

F General Technical

F Fittings

FIL Female I-Line® Sanitary

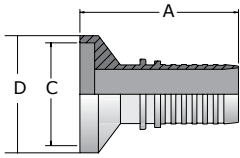

Construction: Stainless Steel.

Part Number #	Hose I.D.		A		Flange Size C		D	
	inch	mm	inch	mm	inch	mm	inch	mm
16-16FIL-S	1	25	2.60	66	1.25	32	2.00	51
24-24FIL-S	1-1/2	38	3.43	87	1.76	45	2.00	51
32-32FIL-S	2	51	4.23	107	2.26	57	2.64	67
40-40FIL-S	2-1/2	64	4.42	112	2.76	70	3.31	84
48-48FIL-S	3	76	4.84	123	3.31	84	3.87	98

MIL Male I-Line® Sanitary

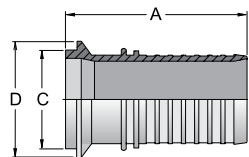

Construction: Stainless Steel.

Part Number #	Hose I.D.		A		Flange Size C		D	
	inch	mm	inch	mm	inch	mm	inch	mm
16-16MIL-S	1	25	2.60	66	1.25	32	2.00	51
24-24MIL-S	1-1/2	38	3.43	87	1.76	45	2.00	51
32-32MIL-S	2	51	4.23	107	2.26	57	2.64	67
40-40MIL-S	2-1/2	64	4.42	112	2.76	70	3.31	84
48-48MIL-S	3	76	4.84	123	3.31	84	3.87	98

FP Female NPTF Pipe Rigid

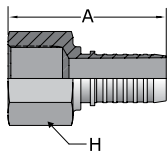

Construction: Stainless Steel.

Part Number #	Thread Size	Hose I.D.		A		H Hex
		inch	mm	inch	mm	inch
04-04FP-S	1/4-18	1/4	6	1.63	41	3/4
06-06FP-S	3/8-18	3/8	10	1.73	44	7/8
08-08FP-S	1/2-14	1/2	13	2.25	57	1-1/16
12-12FP-S	3/4-14	3/4	19	2.60	66	1-5/16
16-16FP-S	1-11 1/2	1	25	2.85	72	1-5/8
20-20FP-S	1 1/4-11 1/2	1-1/4	32	3.50	89	2
24-24FP-S	1 1/2-11 1/2	1-1/2	38	3.63	92	2-3/8
32-32FP-S	2-11 1/2	2	51	4.25	108	2-7/8

NOTE: The PAGE fitting call-out does not follow traditional Parker fitting nomenclature. The end size and hose size are reversed.



WARNING

This product can expose you to chemicals including Lead, which is known to the State of California to cause cancer and birth defects or other reproductive harm. For more information go to www.P65Warnings.ca.gov.

A Hose

MP Male NPTF Pipe Rigid

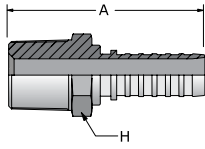

Construction: Stainless Steel.

Part Number	Thread Size	Hose I.D.		A		H Hex
		inch	mm	inch	mm	inch
#						
04-04MP-S	1/4-18	1/4	6	1.63	41	9/16
06-06MP-S	3/8-18	3/8	10	1.76	45	11/16
08-08MP-S	1/2-14	1/2	13	2.34	59	7/8
12-12MP-S	3/4-14	3/4	19	2.59	66	1-1/8
16-16MP-S	1-11 1/2	1	25	3.00	76	1-3/8
20-20MP-S	1 1/4-11 1/2	1-1/4	32	3.39	86	1-3/4
24-24MP-S	1 1/2-11 1/2	1-1/2	38	3.89	99	2
32-32MP-S	2-11 1/2	2	51	4.58	116	2-1/2
40-40MP-S	2-1/2 8	2-1/2	64	5.28	134	3
48-48MP-S	3-8	3	76	5.93	151	3-3/4
64-64MP-S	4-8	4	102	6.82	173	4-5/8

B Tubing

C Coiled Air Hose & Fittings

D Transportation

E Fittings

FJX Female JIC 37° Swivel

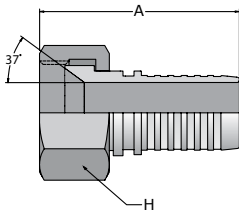

Construction: Stainless Steel.

Part Number	Thread Size	Hose I.D.		A		H Hex
		inch	mm	inch	mm	inch
#						
04-04FJX-S	7/16-20	1/4	6	1.44	37	9/16
06-06FJX-S	9/16-18	3/8	10	1.65	42	11/16
08-08FJX-S	3/4-16	1/2	13	2.13	54	7/8
12-12FJX-S	1-1/16-12	3/4	19	2.54	65	1-1/4
16-16FJX-S	1-5/16-12	1	25	2.76	70	1-1/2
20-20FJX-S	1-5/8-12	1-1/4	32	3.25	83	2
24-24FJX-S	1-7/8-12	1-1/2	38	3.73	95	2-1/4
32-32FJX-S	2-1/2-12	2	51	4.55	116	2-7/8
40-40FJX-S	3-12	2-1/2	64	4.76	121	3-3/8

FORFS Female Seal-Lok® Swivel Short

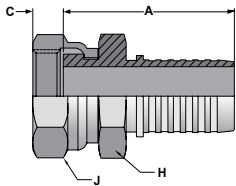

Construction: Stainless Steel.

Part Number	Thread Size	Hose I.D.		A		C		H Hex	J Hex
		inch	mm	inch	mm	inch	mm	inch	inch
#									
04-04FORFS-S	9/16-18	1/4	6	1.50	38	.32	8	9/16	11/16
06-06FORFS-S	11/16-16	3/8	10	1.85	47	.32	8	11/16	13/16
08-08FORFS-S	13/16-16	1/2	13	2.00	51	.43	11	13/16	15/16
12-12FORFS-S	1-3/16-12	3/4	19	2.30	58	.57	14	1-1/8	1-3/8
16-16FORFS-S	1-7/16-12	1	25	2.50	64	.58	15	1-3/8	1-5/8
24-24FORFS-S	2-12	1-1/2	38	3.98	101	.59	15	2	2-1/4

NOTE: The PAGE fitting call-out does not follow traditional Parker fitting nomenclature. The end size and hose size are reversed.

WARNING
 This product can expose you to chemicals including Lead, which is known to the State of California to cause cancer and birth defects or other reproductive harm. For more information go to www.P65Warnings.ca.gov.

F Tooling, Equipment & Accessories

G General Technical

PLCF Female A-LOK® Compression (With Nut & Ferrules)

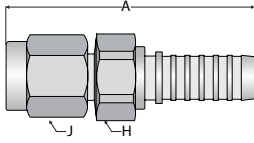

Construction: Stainless Steel.

Part Number	Thread Size	Hose Size		A		H Hex	J Hex
		inch	mm	inch	mm	inch	inch
#							
04-04PLCF-S	7/16-20	1/4	6	1.52	39	9/16	9/16
06-06PLCF-S	9/16-20	3/8	10	1.63	41	11/16	11/16
08-08PLCF-S	3/4-20	1/2	13	2.05	52	7/8	7/8
12-12PLCF-S	1-20	3/4	19	2.30	58	1-1/8	1-1/8
16-16PLCF-S	1-5/16-20	1	25	2.57	65	1-3/8	1-1/2

TUBE A-LOK® Male Standpipe Rigid with "V" Notch

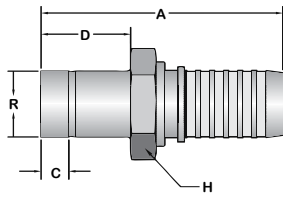

Construction: Stainless Steel.

Part Number	Diameter R	Hose Size		A		C		D		H Hex
		inch	mm	inch	mm	inch	mm	inch	mm	inch
#										
04-04TUBE-S	1/4	1/4	6	1.75	45	.18	5	.66	17	7/16
06-06TUBE-S	3/8	3/8	10	2.06	52	.25	6	.85	2	5/8
08-08TUBE-S	1/2	1/2	13	2.56	65	.34	9	.97	25	3/4
12-12TUBE-S	3/4	3/4	19	2.86	73	.40	10	1.02	26	1-1/8
16-16TUBE-S	1	1	25	3.34	85	.52	13	1.30	33	1-3/8
20-20TUBE-S	1-1/4	1-1/4	32	4.05	10	.50	13	1.75	45	1-3/4

PF ANSI B16.5 Flange

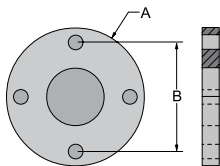

Carbon Steel (Epoxy Coated)	316 Stainless Steel	304 Stainless Steel	Flange Diameter A		Hose Size		Bolt Spacing B	
#	#	#						
Flange	Flange	Flange	inch	mm	inch	mm	inch	mm
08-PF150	08-PF156	08-PF154	3-1/2	89	1/2	13	2-3/8	60
12-PF150	12-PF156	12-PF154	3-7/8	98	3/4	19	2-3/4	70
16-PF150	16-PF156	16-PF154	4-1/4	108	1	25	3-1/8	79
20-PF150	20-PF156	20-PF154	4-5/8	117	1-1/4	32	3-1/2	89
24-PF150	24-PF156	24-PF154	5	127	1-1/2	38	3-7/8	98
32-PF150	32-PF156	32-PF154	6	152	2	51	4-3/4	120
40-PF150	40-PF156	40-PF154	7	178	2-1/2	64	5-1/2	140
48-PF150	48-PF156	48-PF154	7-1/2	191	3	76	6	152
64-PF150	64-PF156	64-PF154	9	229	4	102	7-1/2	191

NOTE: Also available in 300 lb. flange and other materials. Contact Customer Service for options.

NOTE: The PAGE fitting call-out does not follow traditional Parker fitting nomenclature. The end size and hose size are reversed.



WARNING

This product can expose you to chemicals including Lead, which is known to the State of California to cause cancer and birth defects or other reproductive harm. For more information go to www.P65Warnings.ca.gov.

A Hose

SFR Flange Retainer

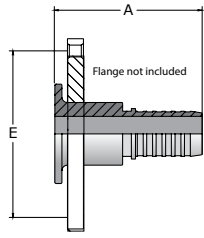

Construction: Stainless Steel.

Part Number	Flange Diameter		Hose Size		A		Bolt Spacing E	
	inch	mm	inch	mm	inch	mm	inch	mm
#	∅		⊙					
08-08SFR-S	3-1/2	89	1/2	13	2.30	58	2-3/8	60
12-12SFR-S	3-7/8	98	3/4	19	2.60	66	2-3/4	70
16-16SFR-S	4-1/4	108	1	25	3.00	76	3-1/8	79
20-20SFR-S	4-5/8	117	1-1/4	32	3.25	83	3-1/2	89
24-24SFR-S	5	127	1-1/2	38	3.65	93	3-7/8	98
32-32SFR-S	6	152	2	51	4.25	108	4-3/4	120
40-40SFR-S	7	178	2-1/2	64	5.00	127	5-1/2	140
48-48SFR-S	7-1/2	191	3	76	5.50	140	6	152
64-64SFR-S	9	229	4	102	7.00	178	7-1/2	191

B Tubing

C Coiled Air Hose & Fittings

MSAN Mini Sanitary Flange

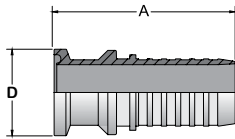

Construction: Stainless Steel.
Compliant ASME-BPE

Part Number	Hose Size		A		Flange Size D	
	inch	mm	inch	mm	inch	mm
#	⊙					
04-04MSAN-S	1/4	6	1.41	36	.98	25
04-08MSAN-S	1/4	6	1.50	38	.98	25
06-06MSAN-S	3/8	10	1.53	39	.98	25
06-08MSAN-S	3/8	10	1.53	39	.98	25
06-12MSAN-S	3/8	10	1.66	42	.98	25
08-08MSAN-S	1/2	13	1.90	48	.98	25
08-12MSAN-S	1/2	13	1.94	49	.98	25
12-12MSAN-S	3/4	19	2.16	55	.98	25
16-16MSAN-S	1	25	2.27	58	1.34	34

D Transportation

SAN Sanitary Flange & Step-Downs

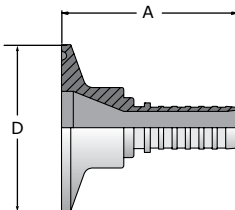

Construction: Stainless Steel.
Compliant ASME-BPE

Part Number	Hose Size		A		Flange Size D	
	inch	mm	inch	mm	inch	mm
#	⊙					
08-08SAN-S	1/2	13	2.11	54	1.98	50
08-16SAN-S	1/2	13	2.11	54	1.98	50
08-24SAN-S	1/2	13	2.34	59	1.98	50
12-12SAN-S	3/4	19	2.32	59	1.98	50
16-16SAN-S	1	25	2.45	62	1.98	50
12-24SAN-S	3/4	19	2.34	59	1.98	50
16-24SAN-S	1	25	2.32	59	1.98	50
24-24SAN-S	1-1/2	38	3.10	79	1.98	50
24-32SAN-S	1-1/2	38	3.12	79	2.52	64
32-32SAN-S	2	51	3.67	93	2.52	64
40-40SAN-S	2-1/2	64	4.00	102	3.05	77
48-48SAN-S	3	76	4.50	114	3.58	91
64-64SAN-S	4	102	4.75	121	4.68	119

F Fittings

G Tooling, Equipment & Accessories

NOTE: The PAGE fitting call-out does not follow traditional Parker fitting nomenclature. The end size and hose size are reversed.

WARNING
 This product can expose you to chemicals including Lead, which is known to the State of California to cause cancer and birth defects or other reproductive harm. For more information go to www.P65Warnings.ca.gov.

G General Technical



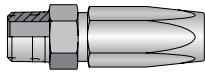
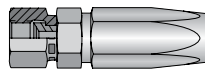
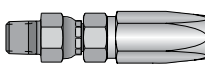

BU Series Visual Index

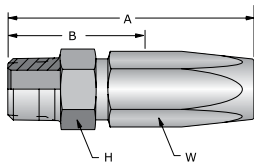
BU Series PERMANENT	201 Male Taper Pipe Rigid	206 Female SAE [JIC] 37° Swivel	213 Male Taper Pipe Swivel
	 E-55	 E-55	 E-55

201BU Male Taper Pipe Rigid





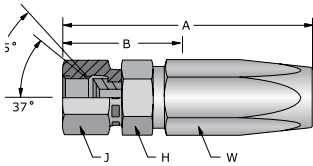

Construction: Steel.

Part Number	Thread Size	Hose I.D.		A		Cutoff Allow. B		H Hex	W Hex
		inch	mm	inch	mm	inch	mm	inch	inch
#									
201BU-2-2	1/8-27	1/8	3	1.50	38	1	25	7/16	7/16

206BU Female SAE (JIC) 37° Swivel



Construction: Steel.



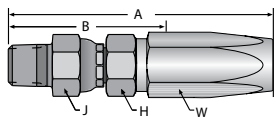

Part Number	Thread Size	Hose I.D.		A		Cutoff Allow. B		H Hex	J Hex	W Hex
		inch	mm	inch	mm	inch	mm	inch	inch	inch
#										
206BU-3-2	3/8-24	1/8	3	1.72	44	1-3/16	30	1/2	9/16	7/16
206BU-4-2	7/16-20	1/8	3	1.77	45	1-3/16	30	9/16	9/16	7/16
206BU-4-3	7/16-20	3/16	5	1.89	48	1-1/16	27	9/16	9/16	7/16

NOTE: Size -4 incorporates a dual seat.

213BU Male Taper Pipe Swivel



Construction: Steel.

Part Number	Thread Size	Hose I.D.		A		Cutoff Allow. B		H Hex	J Hex	W Hex
		inch	mm	inch	mm	inch	mm	inch	inch	inch
#										
213BU-2-2	1/8-27	1/8	3	2.07	53	1-1/2	38	1/2	1/2	7/16

WARNING: Fittings allow minor movement to relieve stress on hose but are not recommended for continued or extensive swiveling.



WARNING

This product can expose you to chemicals including Lead, which is known to the State of California to cause cancer and birth defects or other reproductive harm. For more information go to www.P65Warnings.ca.gov.

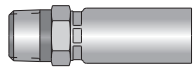
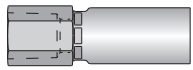
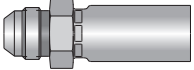
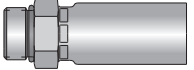
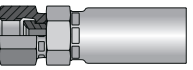
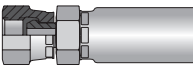
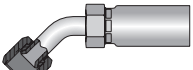
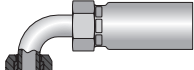
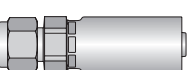
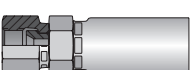
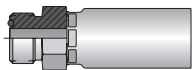
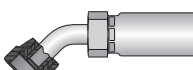
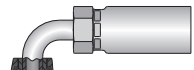
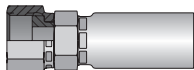
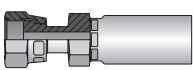
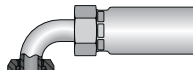
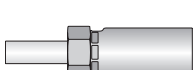

CG Series Visual Index

CG Series PERMANENT	101 Male Taper Pipe Rigid	102 Female Taper Pipe Rigid	103 Male [JIC] 37° Rigid	105 Male Str. Thread O-ring	106 SAE [JIC] 37° Swivel
					
	E-56	E-57	E-57	E-57	E-58
	107 Female Pipe Swivel	137 FM JIC 37° Swivel 45° Elbow	139 FM JIC 37° Swivel 90° Elbow	1AL A-Lok® Compression	1FU [JIS]/BSP 30° Flare Female Swivel
					
E-58	E-59	E-59	E-59	E-60	
1J0 Male Seal-Lok™ Rigid Str. w/O-ring	1J7 Female Seal-Lok™ 45° Elbow	1J9 Female Seal-Lok™ 90° Elbow Short	1JC Female Seal-Lok™ Str. Swivel Short	1JS Female Seal-Lok™ Straight	
					
E-60	E-60	E-60	E-61	E-61	
1L9 FM JIC 37° Swivel 90° Elbow, SPL Drop	1TU Universal Tube Stub End				
					
E-61	E-61				

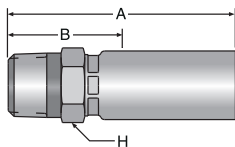
101CG Male Taper Pipe Rigid



Construction: Steel. Add "C" for Stainless Steel.

Part Number	Thread Size	Hose I.D.		A		Cutoff Allow. B		H Hex
		inch	mm	inch	mm	inch	mm	inch
#								
101CG-2-3	1/8-27	3/16	5	1.94	49	1	25	9/16
101CG-2-4	1/8-27	1/4	6	2.13	54	1	25	5/8
101CG-4-3	1/4-18	3/16	5	2.12	54	1-3/16	30	11/16
101CG-4-4	1/4-18	1/4	6	2.31	59	1-3/16	30	11/16
101CG-4-6	1/4-18	3/8	10	2.66	68	1-5/16	33	3/4
101CG-6-4	3/8-18	1/4	6	2.41	61	1-5/16	33	3/4
101CG-6-6	3/8-18	3/8	10	2.66	68	1-5/16	33	3/4
101CG-6-8	3/8-18	1/2	13	2.85	72	1-5/16	33	7/8
101CG-8-6	1/2-14	3/8	10	2.91	74	1-9/16	40	15/16
101CG-8-8	1/2-14	1/2	13	3.09	78	1-9/16	40	15/16
101CG-12-12	3/4-14	3/4	19	3.91	99	1-11/16	43	1-1/4
101CG-16-16	1-11-1/2	1	25	4.76	121	2	51	1-3/4

WARNING This product can expose you to chemicals including Lead, which is known to the State of California to cause cancer and birth defects or other reproductive harm. For more information go to www.P65Warnings.ca.gov.

102CG Female Taper Pipe Rigid

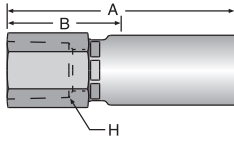

Construction: Steel. Add "C" for Stainless Steel.

Part Number	Thread Size	Hose I.D.		A		Cutoff Allow. B		H Hex
		inch	mm	inch	mm	inch	mm	inch
#								
102CG-4-4	1/4-18	1/4	6	2.39	61	1-1/4	32	3/4
102CG-6-4	3/8-18	1/4	6	2.60	66	1-1/2	38	7/8
102CG-8-8	1/2-14	1/2	13	2.87	73	1-3/8	35	1-1/16

103CG Male (JIC) 37° Rigid

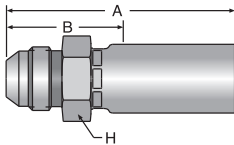

Construction: Steel. Add "C" for Stainless Steel.

Part Number	Thread Size	Hose I.D.		A		Cutoff Allow. B		H Hex
		inch	mm	inch	mm	inch	mm	inch
#								
103CG-4-4	7/16-20	1/4	6	2.31	58	1-3/16	30	5/8
103CG-5-4	1/2-20	1/4	6	2.30	58	1-3/16	30	5/8
103CG-6-4	9/16-18	1/4	6	2.30	58	1-3/16	30	11/16
103CG-6-6	9/16-18	3/8	10	2.65	67	1-1/4	32	3/4

105CG Male Straight Thread O-ring (Nitrile O-ring included)

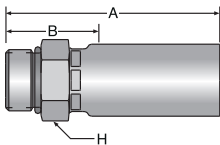

Construction: Steel. Add "C" for Stainless Steel.

Part Number	Thread Size	Hose I.D.		A		Cutoff Allow. B		H Hex
		inch	mm	inch	mm	inch	mm	inch
#								
105CG-4-3	7/16-20	3/16	4	1.98	50	1-1/8	29	9/16
105CG-4-4	7/16-20	1/4	6	2.11	54	1	25	5/8
105CG-6-4	9/16-18	1/4	6	2.14	54	1	25	11/16
105CG-6-6	9/16-18	3/8	10	2.42	61	1-1/8	29	3/4
105CG-8-8	3/4-16	1/2	13	2.65	67	1-3/16	30	7/8
105CG-10-8	7/8-14	1/2	13	2.77	70	1-5/16	33	1



WARNING

This product can expose you to chemicals including Lead, which is known to the State of California to cause cancer and birth defects or other reproductive harm. For more information go to www.P65Warnings.ca.gov.

A Hose

B Tubing

C Coiled Air Hose & Fittings

D Transportation

E Fittings

F Tooling, Equipment & Accessories

G General Technical

A Hose

106CG SAE (JIC) 37° Swivel

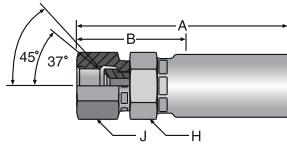

Construction: Steel. Add "C" for Stainless Steel.

Part Number	Thread Size	Hose I.D.		A		Cutoff Allow. B		H Hex	J Hex
		inch	mm	inch	mm	inch	mm	inch	inch
#									
106CG-3-3	3/8-24	3/16	5	2.23	57	1-5/16	33	9/16	9/16
106CG-4-3	7/16-20	3/16	5	2.23	57	1-1/4	32	9/16	9/16
106CG-4-4	7/16-20	1/4	6	2.36	60	1-3/16	30	5/8	9/16
106CG-5-4	1/2-20	1/4	6	2.43	62	1-1/4	32	5/8	5/8
106CG-6-4	9/16-18	1/4	6	2.45	62	1-5/16	33	5/8	11/16
106CG-6-6	9/16-18	3/8	10	2.70	69	1-5/16	33	11/16	11/16
106CG-8-6	3/4-16	3/8	10	2.89	73	1-1/2	38	11/16	7/8
106CG-8-8	3/4-16	1/2	13	3.08	78	1-1/2	38	7/8	7/8
106CG-10-8	7/8-14	1/2	13	3.12	79	1-5/8	41	7/8	1-1/16
106CG-12-8	1-1/16-12	1/2	13	3.35	85	1-13/16	46	1	1-1/4
106CG-12-12	1-1/16-12	3/4	19	4.17	106	1-13/16	46	1-1/4	1-5/16
106CG-16-12	1-5/16-12	3/4	19	4.27	108	2	51	1-1/2	1-5/8
106CG-16-16	1-5/16-12	1	25	4.93	125	2-3/16	56	1-3/4	1-5/8

NOTE: Sizes -4, -5, -8 and -10 incorporate a dual seat.

B Tubing

C Coiled Air Hose & Fittings

D Transportation

107CG Female Pipe Swivel

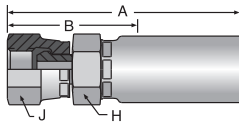

Construction: Steel. Add "C" for Stainless Steel.

Part Number	Thread Size	Hose I.D.		A		Cutoff Allow. B		H Hex	J Hex
		inch	mm	inch	mm	inch	mm	inch	inch
#									
107CG-6-6	3/8-18	3/8	10	2.61	66	1-3/16	30	11/16	7/8

E Fittings

F Tooling, Equipment & Accessories

G General Technical



WARNING

This product can expose you to chemicals including Lead, which is known to the State of California to cause cancer and birth defects or other reproductive harm. For more information go to www.P65Warnings.ca.gov.

137CG Female JIC 37° Swivel 45° Elbow

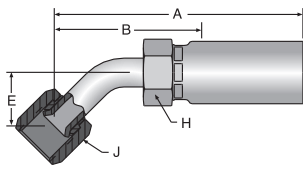

Construction: Steel. Add "C" for Stainless Steel.

Part Number	Thread Size	Hose I.D.		A		Cutoff Allow. B		E		H Hex	J Hex
		inch	mm	inch	mm	inch	mm	inch	mm	inch	inch
#											
137CG-4-4	7/16-20	1/4	6	2.49	63	1-1/2	38	0.33	8	5/8	9/16
137CG-6-6	9/16-18	3/8	10	2.91	74	1-9/16	40	0.39	10	3/4	11/16
137CG-8-8	3/4-16	1/2	13	3.37	86	1-13/16	46	0.55	14	7/8	7/8

139CG Female JIC 37° Swivel 90° Elbow

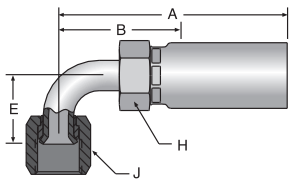

Construction: Steel. Add "C" for Stainless Steel.

Part Number	Thread Size	Hose I.D.		A		Cutoff Allow. B		E		H Hex	J Hex
		inch	mm	inch	mm	inch	mm	inch	mm	inch	inch
#											
139CG-4-4	7/16-20	1/4	6	2.49	63	1-3/8	35	0.68	17	5/8	9/16
139CG-6-4	9/16-18	1/4	6	2.57	65	1-9/16	36	0.85	22	5/8	11/16
139CG-6-6	9/16-18	3/8	10	2.88	73	1-1/2	38	0.91	23	3/4	11/16
139CG-8-6	3/4-16	3/8	10	2.92	74	1-9/16	40	1.09	28	3/4	7/8
139CG-8-8	3/4-16	1/2	13	3.11	79	1-5/8	41	1.09	28	7/8	7/8
139CG-12-12	1-1/16-12	3/4	19	4.55	116	2-1/4	57	1.82	46	1-1/4	1-1/4

1ALCG A-LOK® Compression (With Nut and Ferrule)

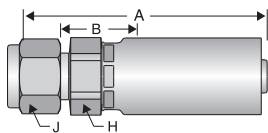

Construction: Stainless Steel.

Part Number	Thread Size	Hose I.D.		A		Cutoff Allow. B		H Hex	J Hex
		inch	mm	inch	mm	inch	mm	inch	inch
#									
1ALCG-6-6C	9/16-20	3/8	3/8	2.56	65	13/16	21	3/4	11/16

NOTE: Nut part No. is **XNUX** or **XNUX-316** for stainless steel.
 Front ferrule part No. is **XFFX** or **XFFX-316** for stainless steel.
 Back ferrule part No. is **XBFX** or **XBFX-316** for stainless steel.
X denotes dash size.

Nuts and Ferrules are Manufactured by the Instrumentation Products Division.
 Refer to Catalog 4300 for additional information



WARNING

This product can expose you to chemicals including Lead, which is known to the State of California to cause cancer and birth defects or other reproductive harm. For more information go to www.P65Warnings.ca.gov.

A Hose

1FUCG (JIS)/BSP 30° Flare Female Swivel ISO 228-1

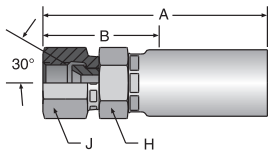

Part Number	Thread Size	Hose I.D.		A		Cutoff Allow. B		H Hex	J Hex
		inch	mm	inch	mm	inch	mm	inch	inch
#									
1FUCG-4-4	PF 1/4-19	1/4	6	2.48	63	1-9/16	40	19	19

Construction: Steel. Add "C" for Stainless Steel.

B Tubing

C Coiled Air Hose & Fittings

1J0CG Male Seal-Lok™ Rigid Straight (with Nitrile O-ring) ISO 12151-1-S

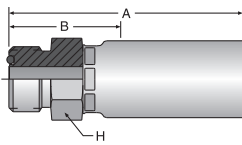

Part Number	Thread Size	Hose I.D.		A		Cutoff Allow. B		H Hex
		inch	mm	inch	mm	inch	mm	inch
#								
1J0CG-4-4	9/16-18	1/4	6	2.20	56	1-1/16	27	5/8

Construction: Steel. Add "C" for Stainless Steel.

D Transportation

1J7CG Female Seal-Lok™ Swivel 45° Elbow ISO 12151-1-SWE45

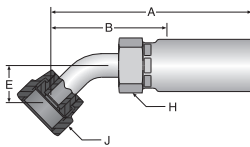

Part Number	Thread Size	Hose I.D.		A		Cutoff Allow. B		E		H Hex	J Hex
		inch	mm	inch	mm	inch	mm	inch	mm	inch	inch
#											
1J7CG-4-4	9/16-18	1/4	6	2.66	68	1-1/2	38	0.41	10	5/8	11/16
1J7CG-8-8	13/16-16	1/2	13	3.43	87	1-15/16	49	0.59	15	7/8	15/16
1J7CG-12-12	1-3/16-12	3/4	19	4.51	115	2-3/16	56	0.81	21	1-1/4	1-3/8

Construction: Steel. Add "C" for Stainless Steel.

E Fittings

1J9CG Female Seal-Lok™ Swivel 90° Elbow Short Drop ISO 12151-1-SWE90

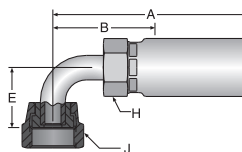

Part Number	Thread Size	Hose I.D.		A		Cutoff Allow. B		E		H Hex	J Hex
		inch	mm	inch	mm	inch	mm	inch	mm	inch	inch
#											
1J9CG-4-4	9/16-18	1/4	6	2.49	63	1-3/8	35	0.82	21	5/8	11/16
1J9CG-6-6	11/16-16	3/8	10	2.85	72	1-1/2	38	0.91	23	3/4	13/16
1J9CG-12-12	1-3/16-12	3/4	19	4.42	112	2-1/8	54	1.89	48	1-1/4	1-3/8
1J9CG-16-16	1-7/16-12	1	25	5.78	147	3	76	2.28	58	1-3/4	1-5/8

Construction: Steel. Add "C" for Stainless Steel.

F Tooling, Equipment & Accessories

WARNING This product can expose you to chemicals including Lead, which is known to the State of California to cause cancer and birth defects or other reproductive harm. For more information go to www.P65Warnings.ca.gov.

G General Technical

1JCCG Female Seal-Lok™ Straight Swivel Short ISO 12151-1-SWSA

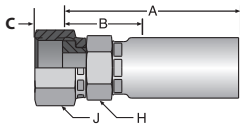

Construction: Steel. Add "C" for Stainless Steel.

Part Number	Thread Size	Hose I.D.		A		Cutoff Allow. B		C		H Hex	J Hex
		inch	mm	inch	mm	inch	mm	inch	mm	inch	inch
#											
1JCCG-4-3	9/16-18	3/16	5	1.88	48	15/16	24	.32	8	9/16	11/16
1JCCG-4-4	9/16-18	1/4	6	2.16	55	1-1/16	25	.32	8	5/8	11/16
1JCCG-6-4	11/16-16	1/4	6	2.22	56	1-1/16	27	.32	8	11/16	13/16
1JCCG-6-6	11/16-16	3/8	10	2.47	63	1-1/16	27	.32	8	11/16	13/16
1JCCG-8-6	13/16-16	3/8	10	2.56	65	1-3/16	30	.43	11	7/8	15/16
1JCCG-8-8	13/16-16	1/2	13	2.75	70	1-3/16	30	.43	11	7/8	15/16
1JCCG-10-8	1-14	1/2	13	2.95	75	1-3/8	35	.53	13	1-1/8	1-1/8
1JCCG-12-12	1-3/16-12	3/4	19	3.86	98	1-1/2	38	.55	14	1-1/4	1-3/8
1JCCG-16-16	1-7/16-12	1	25	4.66	118	1-7/8	48	.56	14	1-3/4	1-5/8

1JSCG Female Seal-Lok™ Straight

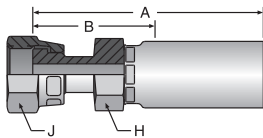

Construction: Steel. Add "C" for Stainless Steel.

Part Number	Thread Size	Hose I.D.		A		Cutoff Allow. B		H Hex	J Hex
		inch	mm	inch	mm	inch	mm	inch	inch
#									
1JSCG-4-4	9/16-18	1/4	6	2.42	61	1-1/4	32	5/8	11/16
1JSCG-6-6	11/16-16	3/8	10	2.73	69	1-5/16	33	11/16	13/16
1JSCG-8-6	13/16-16	3/8	10	3.00	76	1-5/8	41	7/8	15/16
1JSCG-12-12	1-3/16-12	3/4	19	4.29	109	2	51	1-1/4	1-3/8
1JSCG-16-16	1-7/16-12	1	25	4.99	127	2-3/16	56	1-3/4	1-5/8

1L9CG Female JIC 37° Swivel 90° Elbow Special Drop

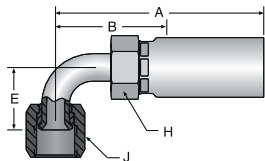

Construction: Steel. Add "C" for Stainless Steel.

Part Number	Thread Size	Hose I.D.		A		Cutoff Allow. B		E		H Hex	J Hex
		inch	mm	inch	mm	inch	mm	inch	mm	inch	inch
#											
1L9CG-4-4	7/16-20	1/4	6	2.47	63	1-3/8	35	0.88	22	5/8	9/16
1L9CG-6-6	9/16-18	3/8	10	2.88	73	1-7/16	36	1.12	28	3/4	11/16

1TUCG Universal Inch Tube Stub End

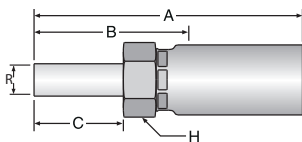

Construction: Stainless Steel.

Part Number	Diameter R	Hose I.D.		A		Cutoff Allow. B		C		H Hex
		inch	mm	inch	mm	inch	mm	inch	mm	inch
#										
1TUCG-4-4C	1/4	1/4	6	2.60	66	1-1/2	38	0.72	18	5/8
1TUCG-6-6C	3/8	3/8	10	2.91	74	1-1/2	38	0.78	20	3/4
1TUCG-8-8C	1/2	1/2	13	3.35	85	1-13/16	46	1.03	26	7/8
1TUCG-12-12C	3/4	3/4	19	4.18	106	1-7/8	48	1.03	26	1-1/4
1TUCG-16-16C	1	1	25	5.14	131	2-3/8	60	1.36	35	1-3/4

NOTE: Use with A-Lok & CPI nuts, sleeves and adapters. These components are manufactured by Parker's Instrumentation Connectors Division. Refer to catalog 4230/4233 for additional information.



WARNING

This product can expose you to chemicals including Lead, which is known to the State of California to cause cancer and birth defects or other reproductive harm. For more information go to www.P65Warnings.ca.gov.

CY Series Visual Index

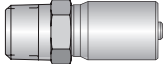
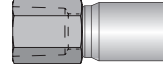
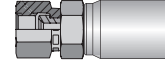
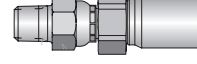
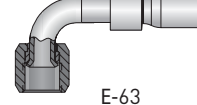
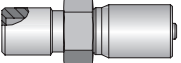
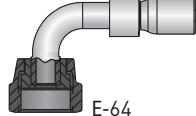
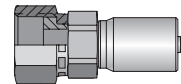
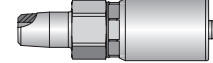
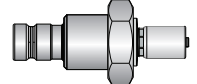

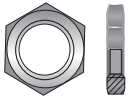
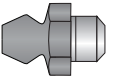
CY Series PERMANENT	101 Male Taper Pipe Rigid	102 Female Pipe Thread	106 Female SAE JIC 37° Swivel	113 Male Pipe Swivel	139 Female JIC 37° Swivel 90° Elbow Sht.
	 E-62	 E-62	 E-63	 E-63	 E-63
	1GK Bulkhead w/Zerk Port Integrated	1J9 Female Seal-Lok™ 90° Elbow Sht.	1JC Female Seal-Lok™ Swivel Straight Short	1LM Male Grease	1PD Integrated Bulkhead Diagnostic Nipple
	 E-64	 E-64	 E-63	 E-64	 E-64

1GKCY OPTIONS	Nut 2GK-Nut	Zerk NA-6520
	 E-64	 E-64

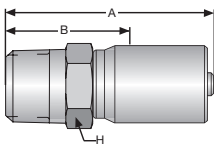
101CY Male Taper Pipe Rigid





Construction: Steel. Add "C" for Stainless Steel.

Part Number	Thread Size	Hose I.D.		A		Cutoff Allow. B		H Hex
		inch	mm	inch	mm	inch	mm	inch
#								
101CY-2-2	1/8-27	1/8	3	1.31	33	13/16	21	7/16
101CY-2-3	1/8-27	3/16	5	1.74	44	7/8	22	1/2
101CY-4-2	1/4-18	1/8	3	1.51	38	1	25	9/16
101CY-4-3	1/4-18	3/16	5	1.97	50	1-1/8	28	9/16

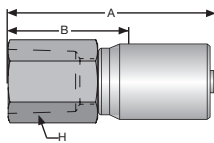
102CY Female Pipe Thread



Construction: Steel. Add "C" for Stainless Steel.

Part Number	Thread Size	Hose I.D.		A		Cutoff Allow. B		H Hex
		inch	mm	inch	mm	inch	mm	inch
#								
102CY-2-3	1/8-27	3/16	5	1.97	50	1-1/16	27	1/2

WARNING This product can expose you to chemicals including Lead, which is known to the State of California to cause cancer and birth defects or other reproductive harm. For more information go to www.P65Warnings.ca.gov.

106CY Female SAE (JIC) 37° Swivel

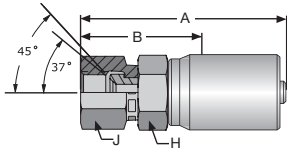

Construction: Steel. Add "C" for Stainless Steel.

Part Number	Thread Size	Hose I.D.		A		Cutoff Allow. B		H Hex		J Hex	
		inch	mm	inch	mm	inch	mm	inch	mm	inch	mm
#											
106CY-2-2	5/16-24	1/8	3	1.52	39	15/16	24	7/16		7/16	
106CY-3-2	3/8-24	1/8	3	1.53	39	1	25	1/2		1/2	
106CY-4-2	7/16-20	1/8	3	1.59	40	1	25	9/16		9/16	
106CY-4-3	7/16-20	3/16	5	1.99	50	1-1/8	29	9/16		9/16	

NOTE: Size -4 incorporates a dual seat.

113CY Male Pipe Swivel*

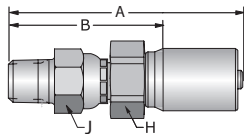

Construction: Steel. Add "C" for Stainless Steel.

Part Number	Thread Size	Hose I.D.		A		Cutoff Allow. B		H Hex		J Hex	
		inch	mm	inch	mm	inch	mm	inch	mm	inch	mm
#											
113CY-2-2	1/8-27	1/8	3	1.89	48	1-5/16	33	1/2		1/2	
113CY-2-3	1/8-27	3/16	3	2.29	58	1-7/16	36	1/2		1/2	

*NOTE: Nitrile O-ring. See O-ring Material Selection section, pg. G-43.

WARNING: Fittings allow minor movement to relieve stress on hose but are not recommended for continued or extensive swiveling.

139CY Female JIC 37° Swivel 90° Elbow Short Drop

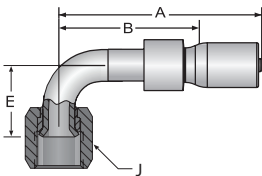

Construction: Steel. Add "C" for Stainless Steel.

Part Number	Thread Size	Hose I.D.		A		Cutoff Allow. B		E		J Hex	
		inch	mm	inch	mm	inch	mm	inch	mm	inch	mm
#											
139CY-4-2	7/16-20	1/8	3	1.61	41	1-1/8	29	0.83	21	9/16	
139CY-4-3	7/16-20	3/16	5	1.90	48	1	25	0.83	21	9/16	

1JCCY Female Seal-Lok™ Swivel Straight Short

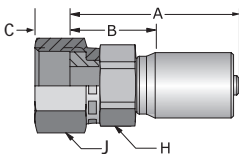

Construction: Steel. Add "C" for Stainless Steel.

Part Number	Thread Size	Hose I.D.		A		Cutoff Allow. B		C		H Hex		J Hex	
		inch	mm	inch	mm	inch	mm	inch	mm	inch	mm	inch	mm
#													
1JCCY-4-2	9/16-18	1/8	3	1.29	33	3/4	19	.32	8	9/16		11/16	

NOTE: When measuring overall length to the end of the nut, B+C dimensions must be used to calculate cut-off allowance.

WARNING This product can expose you to chemicals including Lead, which is known to the State of California to cause cancer and birth defects or other reproductive harm. For more information go to www.P65Warnings.ca.gov.

A Hose

1GKCY Bulkhead with Integrated Zerk Port Bulkhead Nut and Grease Zerk

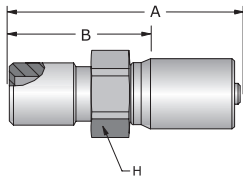

Construction: Steel. Add "C" for Stainless Steel.

Part Number	Thread Size	Hose I.D.		A		Cutoff Allow. B		H Hex
		inch	mm	inch	mm	inch	mm	inch
#								
1GKCY-2-2*	1/8-27 NPSM Male with 1/4-28 UNF Female	1/8	3	1.45	37	7/8	22	1/2
1GKCY-2-3*	1/8-27 NPSM Male with 1/4-28 UNF Female	3/16	5	1.86	47	1	25	1/2
1GKCY-2-2-L77**	1/8-27 NPSM Male with 1/4-28 UNF Female	1/8	3	1.71	43	1-1/4	32	1/2

NOTE: *Standard bulkhead for use with plates up to 1/4" thick. Uses 2GK-NUT, sold separately.
 **Long bulkhead for use with plates under 3/4" thick. Uses 2GK-NUT, sold separately.

B Tubing

C Coiled Air Hose & Fittings

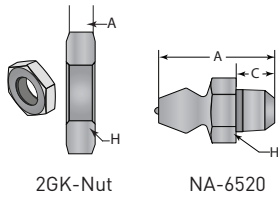

Part Number	Description	Thread Size	A		C		H Hex
2GK-Nut	Bulkhead Nut	1/8-27 NPSM	0.188	4.8	na	na	11/16
NA-6520	Grease Zerk Fitting	1/4-28 UNF	0.540	13.7	0.18	4.6	5/16
CY02-652317	HLB02 Spring Guard	-	-	-	-	-	-
3PSG-4	HLB03 Spring Guard	-	-	-	-	-	-

1J9CY Female Seal-Lok™ 90° Elbow Short Drop

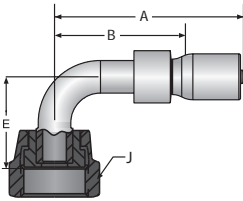

Construction: Steel. Add "C" for Stainless Steel.

Part Number	Thread Size	Hose I.D.		A		Cutoff Allow. B		E	J Hex
		inch	mm	inch	mm	inch	mm	inch	mm
#									
1J9CY-4-2	9/16-18	1/8	3	1.81	46	1-1/4	32	.83	21

D Transportation

1LMCY Male Grease

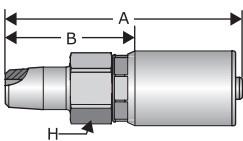

Construction: Steel. Add "C" for Stainless Steel.

Part Number	Thread Size	Hose I.D.		A		Cutoff Allow. B		H Hex
		inch	mm	inch	mm	inch	mm	inch
#								
1LMCY-2-2	1/4-28	1/8	3	1.26	32	11/16	17	3/8

E Fittings

1PDCY Integrated Bulkhead Diagnostic Nipple

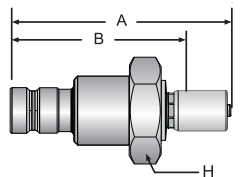

Construction: Steel. Add "C" for Stainless Steel.

Part Number	Thread Size	Hose I.D.		A		Cutoff Allow. B		H Hex
		inch	mm	inch	mm	inch	mm	inch
#								
1PDCY-2-2	3/4"-16 UNF	1/8	3	2.40	61	1.875	48	1

NOTE: Bulkhead nut sold with fitting.

F Tooling, Equipment & Accessories

G General Technical

WARNING This product can expose you to chemicals including Lead, which is known to the State of California to cause cancer and birth defects or other reproductive harm. For more information go to www.P65Warnings.ca.gov.



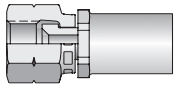
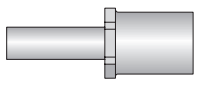
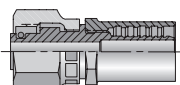

MS Series Visual Index

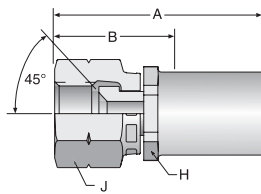
MS Series PERMANENT	108 SAE 45° Swivel	134 Straight Tube	1TF Marine Tube Connector
	 E-65	 E-65	 E-65

108MS Permanent SAE 45° Swivel (Brass)





Construction: Brass

Part Number	Thread Size	Hose I.D.		A		Cutoff Allow. B		H Hex	J Hex
		inch	mm	inch	mm	inch	mm	inch	inch
#									
108MS-6-5B	5/8-18	5/16	8	1.75	45	1-1/8	29	5/8	13/16
108MS-6-6B	5/8-18	3/8	10	1.82	46	1-1/16	27	3/4	13/16

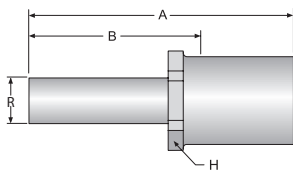
134MS Permanent Straight Tube (Brass)





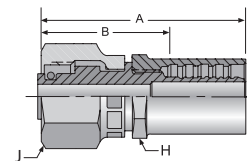

Construction: Brass

Part Number	Diameter R		Hose I.D.		A		Cutoff Allow. B		H Hex
	inch	mm	inch	mm	inch	mm	inch	mm	inch
#									
134MS-6-5B	3/8	10	5/16	8	2.00	51	1-3/8	35	5/8
134MS-6-6B	3/8	10	3/8	10	2.08	53	1-3/8	35	3/4

1TFMS Permanent Marine Tube Connector (Brass)



Construction: Steel nipple, nut and shell.

Part Number	Thread Size	Hose I.D.		A		Cutoff Allow. B		J Hex	H Hex
		inch	mm	inch	mm	inch	mm	inch	inch
#									
1TFMS-6-5B	9/16-24	5/16	8	1.70	43	1 1/16	27	3/4	5/8

NOTE: Connector Mates are Manufactured by the Fluid Systems Connection Division. Refer to Catalog 3501E for Ordering, Installation Instructions and Replacement Components.



WARNING

This product can expose you to chemicals including Lead, which is known to the State of California to cause cancer and birth defects or other reproductive harm. For more information go to www.P65Warnings.ca.gov.



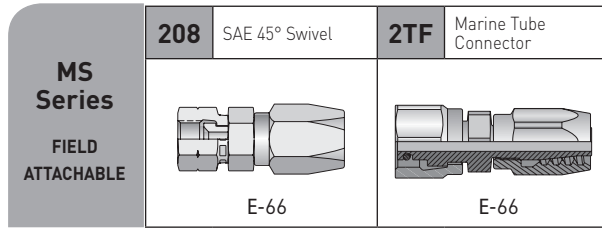

MS Series Visual Index

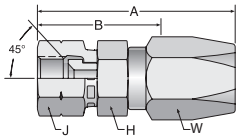

208MS Field-Attachable SAE 45° Swivel (Brass)





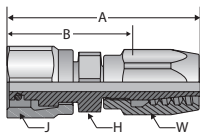

Construction: Brass

Part Number	Thread Size	Hose I.D.		A		Cutoff Allow. B		J Hex	H Hex	W Hex
		inch	mm	inch	mm	inch	mm	inch	inch	inch
#										
208MS-6-5B	5/8-18	5/16	8	2.06	52	1 5/16	33	13/16	5/8	5/8
208MS-6-6B	5/8-18	3/8	10	2.37	60	1 7/16	37	13/16	5/8	5/8

2TFMS Field-Attachable Marine Tube Connector (Brass)



Construction: Brass

Part Number	Thread Size	Hose I.D.		A		Cutoff Allow. B		J Hex	H Hex	W Hex
		inch	mm	inch	mm	inch	mm	inch	inch	inch
#										
2TFMS-6-5B	9/16-24	5/16	8	2.02	51	1 5/16	33	3/4	5/8	5/8

NOTE: Connector Mates are Manufactured by the Fluid Systems Connection Division. Refer to Catalog 3501E for more information.

WARNING This product can expose you to chemicals including Lead, which is known to the State of California to cause cancer and birth defects or other reproductive harm. For more information go to www.P65Warnings.ca.gov.

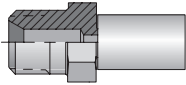
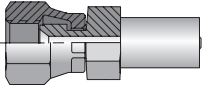
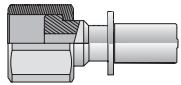
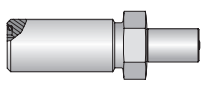

SF Series Visual Index

SF Series PERMANENT	101 Male Taper Pipe Rigid	106 JIC 37° Swivel	1JS Female Seal-Lok™ Swivel Long	1JB Male Seal-Lok™ Bulkhead w/O-ring
	 E-67	 E-67	 E-67	 E-67

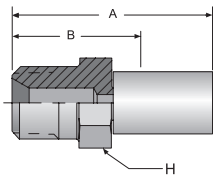
101SF Male Taper Pipe Rigid





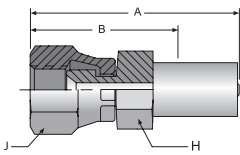

Construction: Steel.

Part Number	Thread Size	Hose I.D.		A		Cutoff Allow. B		H Hex
		inch	mm	inch	mm	inch	mm	inch
#								
101SF-2-1	1/8-27	.090	2.3	1.13	29	3/4	19	7/16

106SF JIC 37° Swivel





Construction: Steel.

Part Number	Thread Size	Hose I.D.		A		Cutoff Allow. B		H Hex	J Hex
		inch	mm	inch	mm	inch	mm	inch	inch
#									
106SF-2-1	5/16-24	.090	2.3	1.37	35	15/16	24	7/16	1/2

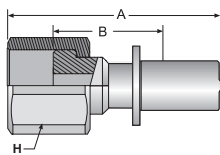
1JSSF Female Seal-Lok™ Swivel Long





Construction: Steel.

Part Number	Thread Size	Hose I.D.		A		Cutoff Allow. B		H Hex
		inch	mm	inch	mm	inch	mm	inch
#								
1JSSF-4-1	9/16-18	.090	2.3	1.18	29.8	3/4	19	11/16

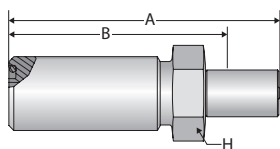
1JBSF Male Seal-Lok™ Bulkhead with O-ring



Construction: Steel.

Part Number	Thread Size	Hose I.D.		A		Cutoff Allow. B		H Hex
		inch	mm	inch	mm	inch	mm	inch
#								
1JBSF-4-1	9/16-18	.090	2.3	2.06	52	1-11/16	43	5/8

NOTE: Bulkhead Locknut sold separately.
WLN Locknuts are manufactured by the Tube Fittings Division. Refer to Catalog 4300 for information.



WARNING

This product can expose you to chemicals including Lead, which is known to the State of California to cause cancer and birth defects or other reproductive harm. For more information go to www.P65Warnings.ca.gov.

SQ Series Visual Index

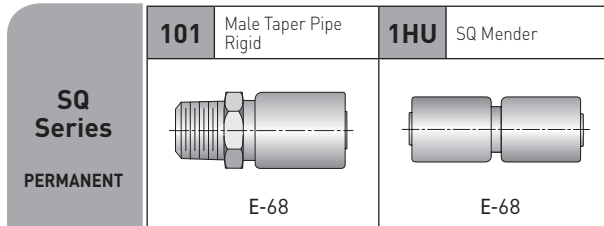

101SQ Male Taper Pipe Rigid

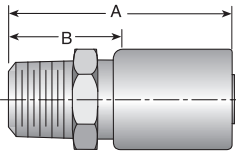

Construction: Steel.

Part Number		Hose I.D.		A		Cutoff Allow. B	
#		⊙					
Hose		inch	mm	inch	mm	inch	mm
S612	101SQ-12-12	3/4	19	3.08	78	1-1/2	38
S616	101SQ-16-16	1	25	3.42	87	1-13/16	46
S912	101SQ-12-12	3/4	19	3.08	78	1-1/2	38
S916	101SQ-16-16	1	25	3.42	87	1-13/16	46

NOTE: See pg. G-36 for swage die selection.

1HUSQ Mender

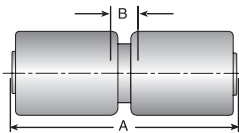

Construction: Steel.

Part Number		Hose I.D.		A		Cutoff Allow. B	
#		⊙					
Hose		inch	mm	inch	mm	inch	mm
S612	1HUSQ-12-12	3/4	19	3.70	94	9/16	14
S616	1HUSQ-16-16	1	25	3.99	101	9/16	14
S912	1HUSQ-12-12	3/4	19	3.70	94	9/16	14
S916	1HUSQ-16-16	1	25	3.99	101	9/16	14

NOTE: See pg. G-36 for swage die selection.



WARNING

This product can expose you to chemicals including Lead, which is known to the State of California to cause cancer and birth defects or other reproductive harm. For more information go to www.P65Warnings.ca.gov.

Equipment & Accessories

MiniKrimp™

Karrykrimp

Karrykrimp 2

Parkrimp2

Pumps

Accessories



Table of Contents

Crimpers

Karrykrimp.....	F-10
Karrykrimp 2.....	F-11
MiniKrimp™	F-5
Parkrimp 2.....	F-12

Pumps

Air Over Hydraulic Pumps	F-13
Electric Pumps.....	F-14
Hand Pumps	F-14

Conversion Kits

Hydraulic Press, Gates, Weatherhead.....	F-16
--	------

Sewer Hose Swager & Swage Tooling

SQ-101-SW Swager/Mender	F-13
-------------------------------	------

Accessories





Cut-off Tools	F-17
Dies (Parkrimp 2).....	F-15
Die Racks	F-15
Hose Guards/Sleeves.....	F-18
Hose Insertion Depth Blocks.....	F-14
Vise Blocks.....	F-14

Technical

MiniKrimp Assembly Detail.....	F-8
Spring/Armor/PVC Guard Selection Tables.....	F-19







Tooling, Equipment & Accessories Visual Index

MiniKrimp™	94C-001-PFD	94C-002-PFD	Hose Stand 94C-MKS
	 F-5	 F-5	 F-7

Karrykrimp	Karrykrimp 82C-061L-PFD	Karrykrimp Bench Mount 82C-KKB-PFD	Karrykrimp2 85C-061L-PFD	Karrykrimp 2 Bench Mount 85C-KKB-PFD
	 F-10	 F-10	 F-11	 F-11

Parkrimp 2	Parkrimp 2 83C-081-PFD
	 F-12

Swagers, Swager Tooling	Swager Mender SQ-101-SW
	 F-13

Pumps	Hand Pump 015301	Hand Pump 82C-0HP-PFD	Hand Pump 85C-0HP-PFD	Air/Hydraulic Pump 025399	Air/Hydraulic Pump 82C-0AP
	 F-13	 F-14	 F-14	 F-13	 F-13
	Electric Pump 82C-0EP-PFD	Electric Pump 85C-0EP-PFD			
	 F-14	 F-14			

Parkrimp Dies	Dies	Die Storage Racks
	 F-15	 F-15

Hose
A

Tubing
B

Coiled Air Hose
& Fittings
C



Transportation
D



Fittings
E





Tooling,
Equipment
& Accessories
F

General
Technical
G

Tooling, Equipment & Accessories Visual Index

Conversion Kits	Hydraulic Press Kit	Weatherhead Kit	Gates Kit
	 F-16	 F-16	 F-16

Vise Blocks	Vise Blocks VBS & VBL	Hose Insertion Depth Blocks	TH-9-1-xxx
	 F-14		 F-14

Cutoff Tools	Hose Cutoff Machine 332T-115V	Push-Lok Cut-Off 885140	Hose Cutter HTC	Hose Cutter TH11-1	Plastic Tube Cutter PTC
	 F-17	 F-17	 F-17	 F-17	 F-17

Hose Guards & Sleeves	AG Flat Steel Armor	AS Partek Sleeve	5CNG CNGG Guard Kit	FS Fire Sleeve	HBR Bend Restrictor
	 F-19	 F-20*	 F-18	 F-20*	 F-18
	PSG and SSG Pre-Made Spring	PSG Parker Spiral Guard	PV Clear Vinyl	SG Steel Spring Guard	2613 Internal FlatSpring
	 F-19	 F-21	 F-18	 F-19	 F-20*
	2625 External Round Spring	2740 External Flat Spring	2799 Internal Round Spring	* Items on page F-20 are for PTFE hose.	
	 F-20*	 F-20*	 F-20*		

Crimping Machines

MiniKrimp™ Hand Pump Model Part No. 94C-001-PFD

The Parker Hannifin MiniKrimp is the best portable crimper on the market. By utilizing a one-piece, high-strength cast aluminum frame, the MiniKrimp is light, robust and highly corrosion resistant.

For use with 54, 56, 91, 91N, 92, 93N, CG, CY, MS, SF, 43 and HY Series fittings



Features

- Lightweight, portable, compact all-in-one unit
- Unit with pump weighs only 42 pounds
- 10,000 psi and 30+ tons of force
- No gauges to set - exclusive Parkalign™ feature positions the fitting correctly every time
- Removable pusher design for easy die change
- Hand pump easily removed for use with jumper hose for bench-mounted units (Part No.- 015309)
- No additional power source required for operation
- Capable of crimping a majority of thermoplastic, rubber, PTFE and specialty hoses up to 3/4" I.D.

Specifications

- Dimensions: 6" Deep, 13" Wide, 15" High
- Weight: 42 lbs with hand pump
- Rating: 30 tons force @ 10,000 psi maximum
- Full Cycle Time: Approximately 30 seconds

Standard Equipment

Part Number		Description	Individual
94C-001-PFD	94C-002 -PFD		Part Number
●	●	Base unit	94C-080-PFD
●		Hand pump	015301
	●	Air over hydraulic pump kit with tubing and adapters	025399
●	●	Silver die ring	82C-R01-PFD

WARNING This product can expose you to chemicals including Lead, which is known to the State of California to cause cancer and birth defects or other reproductive harm. For more information go to www.P65Warnings.ca.gov.

MiniKrimp™ Air Over Hydraulic Model Part No. 94C-002-PFD

The Parker Hannifin MiniKrimp is the best portable crimper on the market. By utilizing a one-piece, high-strength cast aluminum frame, the MiniKrimp is light, robust and highly corrosion resistant.

For use with 54, 56, 91, 91N, 92, 93N, CG, CY, MS, SF, 43 and HY Series fittings



Features

- Lightweight, portable, compact all-in-one unit
- Unit with pump weighs only 45 pounds
- 10,000 psi and 30+ tons of force
- No gauges to set - exclusive Parkalign™ feature positions the fitting correctly every time
- Removable pusher design for easy die change
- Air pump utilizes a rugged activation and release lever for greater durability
- Can operate with as little as 60 psi air pressure (60-100 psi, 9 CFM recommended)
- Capable of crimping a majority of thermoplastic, rubber, PTFE and specialty hoses up to 3/4" I.D.

Specifications

- Dimensions: 6" Deep, 12" Wide, 15" High
- Weight: 45 lbs with air/hydraulic pump
- Rating: 30 tons force @ 10,000 psi maximum
- Full Cycle Time: Approximately 30 seconds

Operating Parameters

Reference Crimpsource™ online or appropriate catalog (4660 or 4400) of the Parker division that supplies the hose for detailed crimp specifications as exceptions do occur based on the particular hose type, size, and fitting material. www.parker.com/crimpsource

A Hose

B Tubing

C Coiled Air Hose & Fittings

D Transportation

E Fittings

F Tooling, Equipment & Accessories

G General Technical

MiniKrimp™ Crimping Machine Accessories

A Hose

B Tubing

C Coiled Air Hose & Fittings

D Transportation

E Fittings

F Tooling, Equipment & Accessories

G General Technical



Upright Vise Mount Part No. 015307

- Material - High Strength Steel
- Mount connects to the bottom of the MiniKrimp using (4) 3/8"-16 18-8 SS SHCS 2.5" long bolts (not included)
- Once connected, the Minikrimp can be clamped into a vise for operation



Side Vise Mount Part No. 015736

- Manufactured from high strength steel
- Mount connects to the side of the MiniKrimp using four 1/4"-20 18-8 SS SHCS, 1" long bolts (not included)
- Once connected, MiniKrimp can be clamped into a vise for operation



Table Mount Part No. 015306

- Material - High Strength Steel
- Mount connects to the bottom of the MiniKrimp using (4) 3/8"-16 18-8 SS SHCS 2.5" long bolts (not included)
- Once connected, the Minikrimp can be mounted to a table using the (4) 3/8" clearance holes on the opposite side of the plate (bolts not included)



High Pressure Hose Assembly Part No. 015309

- Parker 10,000 psi, 1/4" I.D. hose with 3/8" female JIC connections on both ends
- Hose is used when a flexible connection is required between the MiniKrimp and a hydraulic pressure source



Replacement Connector Part No. 015308

- Replacement stainless-steel bent tube rigid connector
- For use with 94C-001-PFD (MiniKrimp Hand Pump Model)



Replacement Connector Part No. 025349

- Replacement stainless-steel bent tube rigid connector
- For use with 94C-002-PFD (MiniKrimp Air Over Hydraulic Model)

Note: The hydraulic connectors shown on this page are designed exclusively for use with the MiniKrimp. No other connectors are approved for use with the MiniKrimp without expressed written consent from Parker Parflex Division's technical support. Any worn connectors should be replaced immediately.



WARNING

This product can expose you to chemicals including Lead, which is known to the State of California to cause cancer and birth defects or other reproductive harm. For more information go to www.P65Warnings.ca.gov.



Folding Stand

Part No. 94C-MKS

(See pictures below for configuration examples)

- Lightweight folding stand designed exclusively for the MiniKrimp portable crimper
- Fold up design is easy to store
- Mounting hardware and safety instructions are included
- Patented design



Hand Pump
MiniKrimp™



Air Over Hydraulic
MiniKrimp™ and
Folding Stand



Hand Pump
MiniKrimp™



Air Over Hydraulic
MiniKrimp™



WARNING

This product can expose you to chemicals including Lead, which is known to the State of California to cause cancer and birth defects or other reproductive harm. For more information go to www.P65Warnings.ca.gov.

A
Hose

B
Tubing

C
Coiled Air Hose
& Fittings

D
Transportation

E
Fittings

F
Tooling,
Equipment
& Accessories

G
General
Technical

MiniKrimp™ Assembly Detail & Parts List

Hand Pump Model

Part No.	Description	Qty.
015301	2 Speed Light Weight Hand Pump	1
015302	Hardened Steel Sleeve	1
015303	Custom Cylinder	1
015304	Aluminum Frame	1
015305	Cup Pusher	1
015306	Bent Tube Assembly	1
015310	3/8" x 3/8" Shoulder Bolt	1
015415	Spring Plunger	1
6 CTX-S	3/8" 37° to 1/4" NPT Elbow	1
6-6 CTX-S	3/8" 37° to 3/8" NPT Elbow	1
822011	Die Separator	1
822012	Spring	1
822031	Retention Ring	1
82C-R01-PFD	Silver Die Ring	1
015411	3/8-16 18-8 SS SHCS 2.5" Long	2
015413	1/4-20 18-8 SS Lock Washer	2
015414	1/4-20 18-8 SS Flat Washer	2
015412	1/4-20 18-8 SS SHCS .75" Long	4

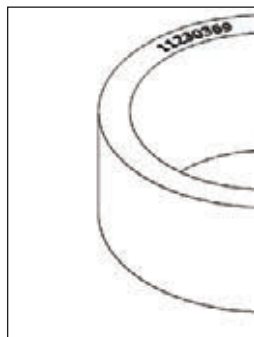
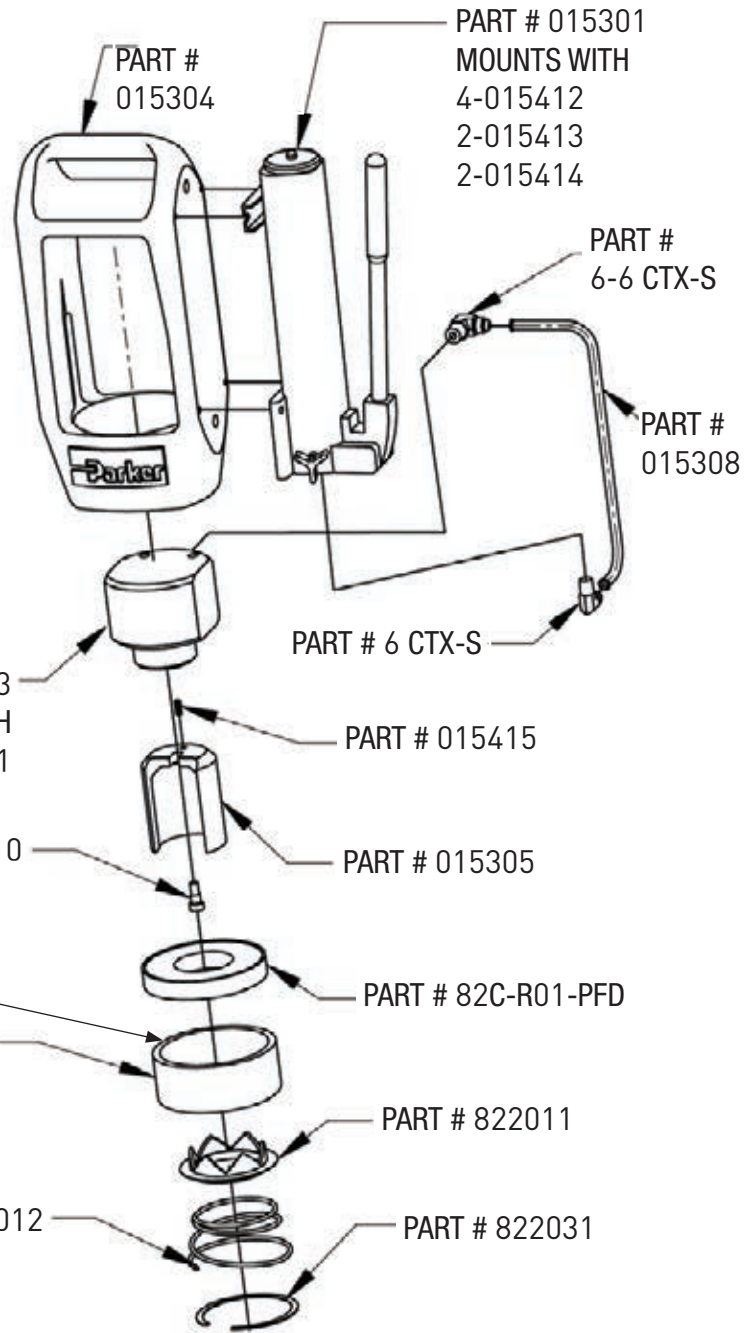

MiniKrimp™ Serial Number

WARNING This product can expose you to chemicals including Lead, which is known to the State of California to cause cancer and birth defects or other reproductive harm. For more information go to www.P65Warnings.ca.gov.

Air Over Hydraulic Model

A
Hose

B
Tubing

C
Coiled Air Hose
& Fittings

D
Transportation

E
Fittings

F
Tooling,
Equipment
& Accessories

G
General
Technical

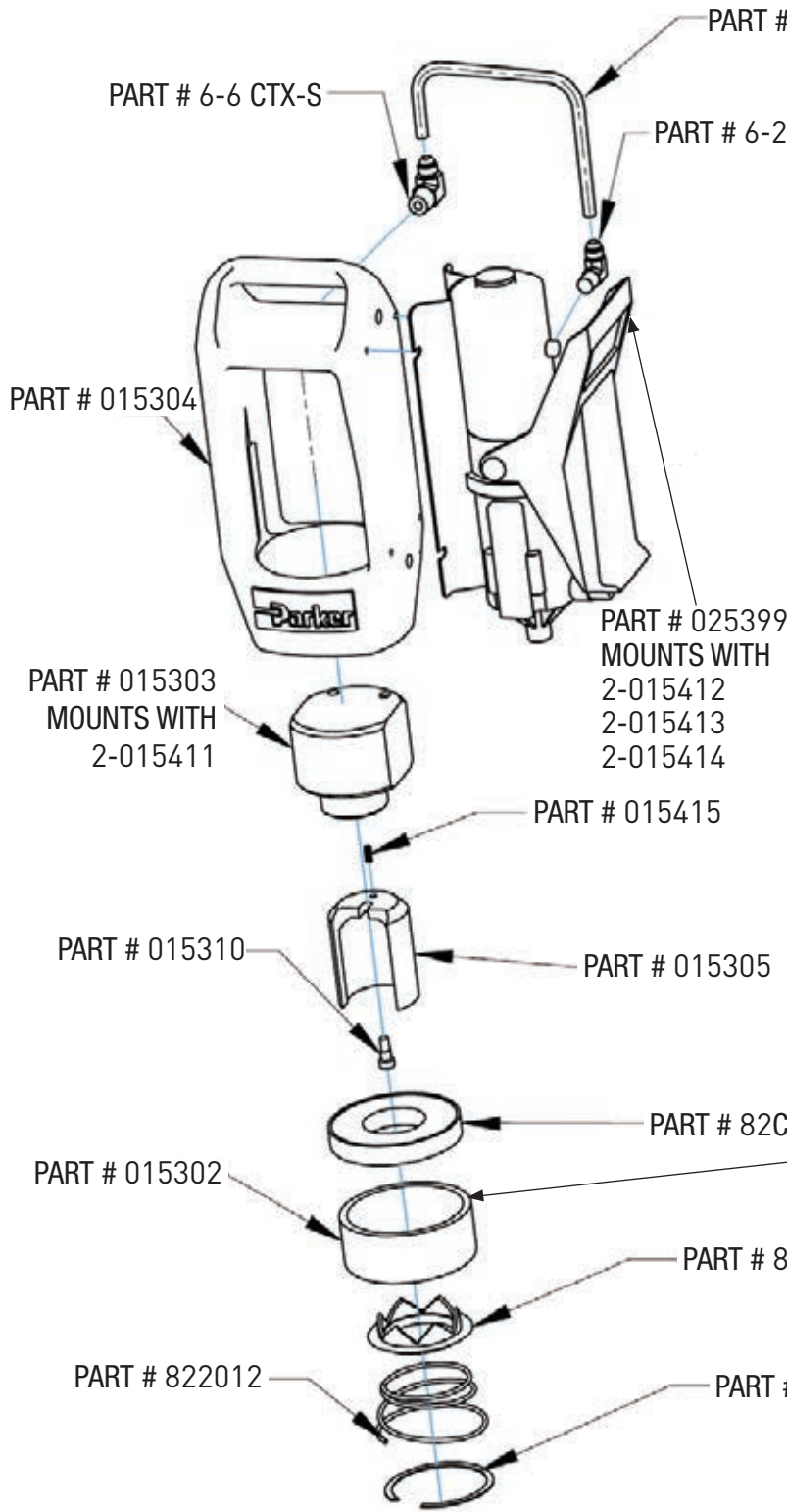

Part No.	Description	Qty.
015302	Hardened Steel Sleeve	1
015303	Custom Cylinder	1
015304	Aluminum Frame	1
015305	Cup Pusher	1
015310	3/8" x 3/8" Shoulder Bolt	1
015415	Spring Plunger	1
6-2 CTX-S	3/8" 37° to 1/8" NPT Elbow	1
6-6 CTX-S	3/8" 37° to 3/8" NPT Elbow	1
822011	Die Separator	1
822012	Spring	1
822031	Retention Ring	1
82C-R01-PFD	Silver Die Ring	1
015411	3/8-16 18-8 SS SHCS 2.5" Long	2
015413	1/4-20 18-8 SS Lock Washer	2
015414	1/4-20 18-8 SS Flat Washer	2
015412	1/4-20 18-8 SS SHCS .75" Long	2
025349	Bent Tube Assembly	1
025399	Air Powered Pump	1

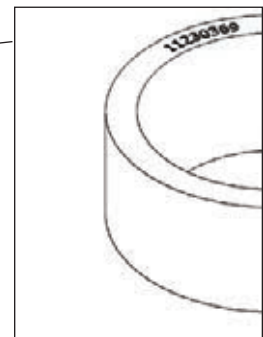

MiniKrimp™ Serial Number



WARNING

This product can expose you to chemicals including Lead, which is known to the State of California to cause cancer and birth defects or other reproductive harm. For more information go to www.P65Warnings.ca.gov.

Karrykrimp

Part No. 82C-061L-PFD



The Karrykrimp is now available in a modular design with all the familiar Parkrimp System advantages.

The same unit now offers portability and bench mountability.

Capability

- Crimps most hoses up to 1-1/4 I.D. (check crimpsource for details)

Features

- Portable, compact rugged design
- Numerous portable power unit options available
- Pivoting pusher design for easy die change out
- Increased height enables longer bent tube fittings to be crimped
- For use with 54, 56, 91, 91N, 92, 93N, CG, CY, MS, SF, 43 and HY Series fittings

Specifications

- Dimensions: 15" wide, 12" deep, 30" high
- Weight: 60 lbs (without power unit)
- Rating: 30 ton force @ 10,000 psi maximum
- Full Cycle Time: 30 seconds

Standard Equipment

Part Number			Description	Individual
82C-CHD-PFD	82C-061L-PFD	82C-KKB-PFD		Part Number
●	●	●	Crimp Head	82C-CHD-PFD
		●	Bench Power Unit Assembly	85C-1PH-PFD
●	●	●	Silver die ring	82C-R01-PFD
●	●	●	Black die ring	82C-R02-PFD
	●		Hose Assembly	85C-00L-PFD
	●		Stand Assembly	85C-STD-PFD



WARNING

This product can expose you to chemicals including Lead, which is known to the State of California to cause cancer and birth defects or other reproductive harm. For more information go to www.P65Warnings.ca.gov.

Karrykrimp Bench Mount

Part No. 82C-KKB-PFD



Capability

- Crimps most hoses up to 1-1/4 I.D. (check crimpsource for details)

Features

- Faster cycle times on bench mounted units
- Pivoting pusher design for easy die change out
- Compact bench mount design
- Increased height enables longer bent tube fittings to be crimped
- For use with 54, 56, 91, 91N, 92, 93N, CG, CY, MS, SF, 43 and HY Series fittings

Specifications

- Dimensions: 17" wide, 23" deep, 27-1/2" high
- Weight: 146 lbs
- Rating: 30 ton force @ 10,000 psi maximum
- Full Cycle Time: 11 seconds
- Hydraulic Fluid: AW32 oil

This unit is designed to make about 400 crimps per day and is not designed to be a production crimper. Exceeding these suggested production amounts will significantly reduce the life expectancy of the crimper components.

Note:

Motor is dual voltage, 50/60hz suitable for 208-230/115v, 1ph, 60hz and 220-230/110v, 1ph, 50hz. Motor can be rewired by a qualified electrician to operate at alternate voltage.

Karrykrimp 2

Part No. 85C-061L-PFD

The Karrykrimp 2 is now available in a modular design with all the familiar Parkrimp System advantages.

The same unit now offers portability and bench mountability.



Capability

- Crimps most hoses up to 1-1/4 I.D. (check crimpsource for detail)

Features

- Portable, compact rugged design
- Numerous portable power unit options available
- Pivoting pusher design for easy die change out
- For use with 54, 56, 91, 91N, 92, 93N, CG, CY, MS, SF, 43 and HY Series fittings

Specifications

- Dimensions: 14" wide, 14" deep, 31-1/2" high
- Weight: 120 lbs (without power unit)
- Rating: 60 ton force @ 10,000 psi maximum
- Full Cycle Time: 20 seconds

Standard Equipment

Part Number			Description	Individual
85C-CHD-PFD	85C-061L-PFD	85C-KKB-PFD		Part Number
●	●	●	Crimp Head	85C-CHD-PFD
		●	Bench Power Unit Assembly	85C-1PH-PFD
●	●	●	Silver die ring	85C-R01-PFD
●	●	●	Black die ring	85C-R02-PFD
	●		Hose Assembly	85C-00L-PFD
	●		Stand Assembly	85C-STD-PFD



WARNING

This product can expose you to chemicals including Lead, which is known to the State of California to cause cancer and birth defects or other reproductive harm. For more information go to www.P65Warnings.ca.gov.

Karrykrimp 2 Bench Mount

Part No. 85C-KKB-PFD



Capability

- Crimps most hoses up to 1-1/4 I.D. (check crimpsource for detail)

Features

- Faster cycle times on bench mounted units
- Pivoting pusher design for easy die change out
- Compact bench mount design
- For use with 54, 56, 91, 91N, 92, 93N, CG, CY, MS, SF, 43 and HY Series fittings

Specifications

- Dimensions: 17" wide, 23" deep, 28" high
- Weight: 208 lbs
- Rating: 60 ton force @ 10,000 psi maximum
- Full Cycle Time: 17 seconds
- Hydraulic Fluid: AW32 oil

This unit is designed to make about 400 crimps per day and is not designed to be a production crimper. Exceeding these suggested production amounts will significantly reduce the life expectancy of the crimper components.

Note:

Motor is dual voltage, 50/60hz suitable for 208-230/115v, 1ph, 60hz and 220-230/110v, ph, 50hz. Motor can be rewired by a qualified electrician to operate at alternate voltage.

A Hose

B Tubing

C Coiled Air Hose & Fittings

D Transportation

E Fittings

F Tooling, Equipment & Accessories

G General Technical

Parkrimp 2

Part No. 83C-081-PFD



Capability

- Crimps hoses up to 2" I.D.
(reference crimp source for details)

Features

- Easy to use vertical design
- Crimps full range of Parker hoses from 1/8" through 2" I.D.
- For use with 54, 56, 91, 91N, 92, 93N, CG, CY, MS, SF, 43 and HY Series fittings

Specifications

- Dimensions: 31" wide, 24" deep, 77" high
- Weight: 842 lbs (Head is 558 lbs and base is 284 lbs)
- Rating: 125 ton force @ 5,000 psi maximum
- Full Cycle Time: 30 seconds without adapter bowl
20 seconds with adapter bowl
- Hydraulic oil: Enerpac oil only

Standard Equipment

Part Number				Individual	
83C-001-PFD	83C-081-PFD	83C-002-PFD	83C-082-PFD	Description	Part Number
●	●	●	●	Parkrimp 2 crimper head assembly	83C-080-PFD
●	●			Parkrimp 2 stand assembly with 230/460 volt, 3 phase, 50/60 Hz power unit (wired for 230 volt)	83C-S40-PFD
		●	●	Parkrimp 2 stand assembly with 230 volt, 1 phase, 50/60 Hz power unit	83C-S20-PFD
●	●	●	●	Adapter bowl	83C-OCB-PFD
●	●	●	●	Spacer ring	83C-R02-PFD
●	●	●	●	Spacer Plate	83C-R02H-PFD



WARNING

This product can expose you to chemicals including Lead, which is known to the State of California to cause cancer and birth defects or other reproductive harm. For more information go to www.P65Warnings.ca.gov.

Crimper Pumps

Air/Hydraulic Pump

Part No. 82C-0AP-PFD



(for use with the MiniKrimp, Karrykrimp and Karrykrimp 2)

Lightweight pump operates with 80-110 psi shop air pressure and delivers 10,000 psi

- Length: 15"
- Width: 6"
- Height: 6"
- Intake Port Size: 1/4" NPTF
- Output Port Size: 3/8" NPTF
- Weight: 14 lbs.
- Hydraulic Fluid: Enerpac oil only

Air/Hydraulic Pump

Part No. 025399



(for use with the MiniKrimp)

Lightweight pump operates with 80-110 psi shop air pressure and delivers 10,000 psi

- Length: 13"
- Width: 4-1/2"
- Height: 5"
- Intake Port Size: 1/4" NPTF
- Output Port Size: 1/8" NPTF
- Weight: 12 lbs.
- Hydraulic Fluid: Enerpac oil only

Hand Pump

Part No. 015301



(for use with the MiniKrimp)

Ease of operation hand pump delivers 10,000 psi

- Length: 13-3/8"
- Width: 3-1/4"
- Height: 3-5/8"
- Port Size: 1/4" NPTF
- Weight: 4.7 lbs.
- Hydraulic Fluid: Enerpac oil only

Swagers



SQ-101-SW Swager/Mender

- Used for field assembly or repair on Predator S6 and S9 hoses



WARNING

This product can expose you to chemicals including Lead, which is known to the State of California to cause cancer and birth defects or other reproductive harm. For more information go to www.P65Warnings.ca.gov.

Hand Pump

Part No. 82C-0HP-PFD



(for use with the MiniKrimp, Karrykrimp and Karrykrimp 2)
Ease of operation hand pump delivers 10,000 psi

- Length: 23"
- Width: 4"
- Height: 5"
- Port Size: 3/8" NPTF
- Weight: 9.0 lbs.
- Hydraulic Fluid: Enerpac oil only

Hand Pump

Part No. 85C-0HP-PFD



(for use with the MiniKrimp, Karrykrimp and Karrykrimp 2)
Ease of operation hand pump delivers 10,000 psi

- Length: 29"
- Width: 13"
- Height: 11"
- Port Size: 3/8" NPTF
- Weight: 61 lbs
- Hydraulic Fluid: Enerpac oil only

Electric Pump

Part No. 82C-0EP-PFD



(for use with the MiniKrimp, Karrykrimp and Karrykrimp 2)
Ease of operation electric pump delivers 10,000 psi

- Length: 13"
- Width: 13"
- Height: 15"
- Port Size: 3/8" NPTF
- Weight: 31 lbs.
- Hydraulic Fluid: Enerpac oil only
- 115 volt, 1 phase, 50/60 Hz, 9 amp

Electric Pump

Part No. 85C-0EP-PFD



(for use with the MiniKrimp, Karrykrimp and Karrykrimp 2)
Heavy duty electric pump delivers 10,000 psi at a faster cycle time

- Length: 19"
- Width: 11"
- Height: 17"
- Port Size: 3/8" NPTF
- Weight: 59 lbs.
- Hydraulic Fluid: Enerpac oil only
- 115 volt, 1 phase, 50/60 Hz, 20 amp

Vise Blocks

For Parflex Hose Sizes



Part Number	Hose Size	
	VBS	-3
-4		1/4
-5		5/16
-6		3/8
-8		1/2
VBL	-12	3/4
	-16	1

Hose Insertion Depth Blocks

Part No. TH9-1-xxx



Part Number	Description
TH9-1-CG	CG Series. All sizes.
TH9-1-56	56 Series. All sizes.
TH9-1-54A	54 Series All sizes.
TH9-1-91N	91N Series. All sizes.
TH9-1-93N_20-32	93N Series. Sizes: -20, -24, -32
TH9-1-93N_6-16	93N Series. Sizes: -6, -12, -16
TH9-1-94_95	94 & 95 Series. All sizes.
TH9-1-CY_SF	CY & SF Series. All sizes.
TH9-1-MS	MS Series. All sizes.
TH9-1-HY	HY Series. All sizes.



WARNING

This product can expose you to chemicals including Lead, which is known to the State of California to cause cancer and birth defects or other reproductive harm. For more information go to www.P65Warnings.ca.gov.

Parflex Parkrimp Dies



Parkrimp dies, specifically engineered for thermoplastic and fluoropolymer hose:

- Linked die segments
- Pre-matched and assembled
- Fitting size color coded

Color Code	
Size	Color
-1.5	● GR
-2	● BR
-3	● GR
-4	● R
-5	● P

Color Code	
Size	Color
-6	● Y
-8	● BL
-10	● O
-12	● G
-16	● B

Color Code	
Size	Color
-20	○ W
-24	● R
-32	● G

Parkrimp Approved Silver Die Rings	
Machine	Approved Die
Parkrimp 2	NA*
Karrykrimp and MiniKrimp	82C-R01-PFD
Karrykrimp 2	85C-R01-PFD

*No additional silver die rings required.

Note: 1) Parflex dies have been designed for use with the silver die ring. Silver die rings are to be used with all Parflex hoses unless otherwise specified.

2) For most Parker products, Crimp Die information and selection charts can be found online at www.parker.com/crimpsource. Access instructions are on pg. G-14.

Die Racks



Die Storage Rack

Part No. 80C-0DR-PFD/83C-0DR-PFD

- Holds small and large Parkrimp dies
- Can be bolted together to a work bench

Description	Part No.
Storage 3 small dies	80C-0DR-PFD
Storage 2 large dies	83C-0DR-PFD



Swivel Die Rack

Part No. 80C-SDR-XXXX-PFD

- Holds up to 30 Parkrimp dies
- Powder coated, heavy duty steel construction
- Consist of base unit and up to 5 circular holders
- Floor or bench mounted

Description	Part No.
Swivel Die Rack and Small Die Holder	80C-SDR-SM-PFD
Swivel Die Rack and Large Die Holder	80C-SDR-LG-PFD
Swivel Die Rack Base	80C-SDR-BASE-PFD



WARNING

This product can expose you to chemicals including Lead, which is known to the State of California to cause cancer and birth defects or other reproductive harm. For more information go to www.P65Warnings.ca.gov.

Conversion Kits



Hydraulic Press Kit

Specifications

- Required Height from Press Base to Press Ram: 10 inches
- Required Width of Bowl Diameter: 5 inches
- Bowl Rating: 30 tons force maximum
- Minimum Required Press Capacity: Hose Size 1/4" to 1/2" needs a 20 ton press
Hose size 5/8" to 1-1/4" needs a 30 ton press

Standard Equipment

Each component must be ordered separately	Individual
Description	Part Number
Bowl Assembly	8PC-030-PFD
Pusher	8PC-00P-PFD
Silver Die Ring	81C-R01-PFD
Black Die Ring	81C-R02-PFD



Weatherhead Conversion Kit

Weatherhead T-400 crimper to utilize Parker Parkrimp No-Skive fittings.

Standard Equipment

Each component must be ordered separately	Individual
Description	Part Number
Bowl Assembly	8PC-030-PFD
Pusher	8WC-00P-PFD
Silver Die Ring	81C-R01-PFD
Black Die Ring	81C-R02-PFD



Gates Conversion Kit

Convert Gates 701, 703 and 707 bottom loading crimpers to utilize Parker Parkrimp No-Skive fittings.

Standard Equipment

Each component must be ordered separately	Individual
Description	Part Number
Bowl Assembly	8PC-030-PFD
Silver Die Ring	81C-R01-PFD
Black Die Ring	81C-R02-PFD



WARNING

This product can expose you to chemicals including Lead, which is known to the State of California to cause cancer and birth defects or other reproductive harm. For more information go to www.P65Warnings.ca.gov.

Cutting Tools



Hose Cut-Off Machine Part No. 332T-115V-PFD

Features

- For quick, easy cutting of reinforced hose up to 1-1/4" I.D.
- Moving parts shielded by guards

Specifications

- Dimensions: 13" wide x 26" long x 22" high
- Shipping Weight: 71 lbs.

Standard Equipment

Part Number	Description	Individual Part Number
332T-115V-PFD		
●	Hose Cut-Off Machine with 1-1/2 HP, 3450 RPM, 115/230V single phase electric motor wired for 115V	332T-115V-PFD
●	Scallop Cutting Blade (8" with 5/8" arbor size)	24398-PFD

Optional Equipment

Smooth Cutting Blade (580661-PFD)



Push-Lok Cut-Off & Assembly Tool Part No. 881540-PFD

- Combines hose cutter and toggle action press
- Cuts and assembles Parker 83FR in sizes 1/4" through 3/4" I.D.



Hose & Tubing Cutter Part No. HTC

- Special V-block design with easy adjustable blade ensures a straight, clean cut
- Minimal flattening of hose/tubing during cutting - Straight, square cut enhances fitting retention
- Cuts up to 1" O.D. hose or tubing (Non-wire reinforced thermoplastic hose and tubing and rubber hose and tubing)
- Replacement blades: HTC-RB



Hose Cut-Off Tool Part No. TH11-1-PFD

- Designed for quick, easy cutting of textile reinforced hose
- Squarely cuts fiber reinforced hoses in sizes 1/4" through 3/4" I.D.



Plastic Tube Cutter Part No. PTC

- Razor-edged tube cutter
- Closes automatically, assuring clean and square cuts
- May be used with most plastic tubing up to 5/8" I.D.

Description

Part Number

Replacement Blades.....PTC-001-RB



WARNING

This product can expose you to chemicals including Lead, which is known to the State of California to cause cancer and birth defects or other reproductive harm. For more information go to www.P65Warnings.ca.gov.

A Hose

B Tubing

C Coiled Air Hose & Fittings

D Transportation

E Fittings

F Tooling, Equipment & Accessories

G General Technical

Hose Guards

Parker hose guards prolong the life of hoses that are exposed to rugged operating conditions. In addition to protecting the hose from abrasion and cutting, they limit the bending radius which prevents kinking.

PV - Clear Vinyl Hose Guard

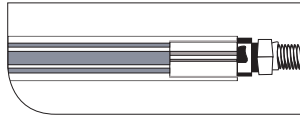

Part Number	Guard I.D.		Standard Length	
	inch	mm	feet	mtr.
#	⊙			
PV97-1	0.44	11	100	30.5
PV139-1	0.56	14	100	30.5
PV1611-1	0.68	17	100	30.5
PV2014-1	0.87	22	50	15.2
PV2420-1	1.25	32	50	15.2
PV3224-1	1.50	38	50	15.2

HBR - Hose Bend Restrictor (Black Elastomer)

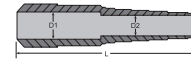

Part Number	Hose Size		L		D1		D2	
	inch	mm	inch	mm	inch	mm	inch	mm
#	⊙							
HBR-4	1/4	6	5	127	.600	15	.500	13
HBR-6	3/8	10	6	152	.640	16	.625	16

Parker reserves the right to change dimensions and performance parameters without notice.

5CNG/5CNGLT - Black Vinyl CNG Hose Guard

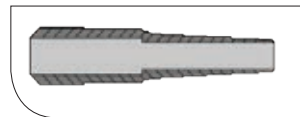

Hose Part Number	Hose Guard Part Number
#	#
5CNG-3	CNGG5-3
5CNG-4	CNGG5-4
5CNG-6	HBR-6
5CNG-8	CNGG5-8
5CNG/5CNGLT-12	CNGG5-12
5CNG-16	CNGG5-16

- Use with Parflex CNG hose
- Contact Parflex Division for information on Hose Guard Kits.

WARNING This product can expose you to chemicals including Di(2-ethylhexyl) phthalate (DEHP), which is known to the State of California to cause cancer and birth defects or other reproductive harm. For more information go to www.P65Warnings.ca.gov.

Metallic Spring Guards

Use Spring Guards for protection from abrasion and extreme physical abuse.

SSG & PSG - Pre-made Spring Guards

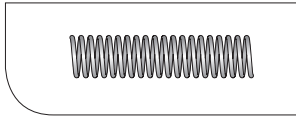

Plated, hard-drawn steel wire

Part Number	Hose O.D. (reference)		Standard Length	
	inch	mm	inch	mm
#	⊙			
55SSG-3	0.44	11	6	152
55SSG-4	0.55	14	6	152
55SSG-5	0.61	15	6	152
55SSG-6	0.68	17	6	152
55SSG-8	0.83	21	6	152
55SSG-12	1.09	28	7	178

Special configurations available upon request. Contact factory.

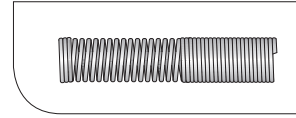

For CNG Hose (Stainless Steel)

Part Number	Hose Max. O.D.		Standard Length	
	inch	mm	inch	mm
#	⊙			
3PSG-3	0.46	12	5.30	135
3PSG-4	0.54	14	6.25	159
5PSG-4	0.57	14	6.25	159
5PSG-6	0.68	17	6.50	165
5PSG-8	0.90	23	6.50	165

SG - Steel Spring Guards (Plated, hard-drawn steel wire)

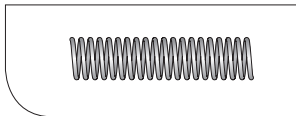

Part Number	Hose O.D. (reference)		Standard Length	
	inch	mm	feet	mtr.
#	⊙			
55SG-3	0.47	12	25	7.6
55SG-4	0.55	14	25	7.6
55SG-5	0.61	16	25	7.6
55SG-6	0.67	17	25	7.6
55SG-8	0.83	21	25	7.6
55SG-12	1.09	28	10	3
55SG-16	1.35	34	10	3
58SG-12	1.18	30	10	3
58SG-16	1.51	38	10	3

AG - Flat Steel Armor Guards

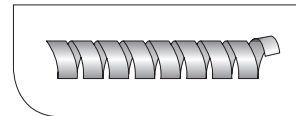

Part Number	Guard I.D.		Standard Length	
	inch	mm	feet	mtr.
#	⊙			
55AG-3	0.47	12	25	7.6
55AG-4	0.55	14	25	7.6
55AG-5	0.61	16	25	7.6
55AG-6	0.67	17	25	7.6
55AG-8	0.83	21	25	7.6
55AG-12	1.09	28	10	3
55AG-16	1.35	34	10	3
58AG-12	1.18	30	10	3
58AG-16	1.51	38	10	3



WARNING

This product can expose you to chemicals including Lead, which is known to the State of California to cause cancer and birth defects or other reproductive harm. For more information go to www.P65Warnings.ca.gov.

Guards for PTFE Hoses

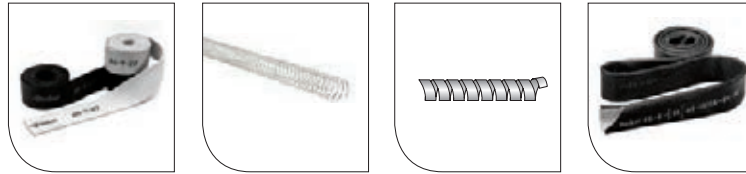

AS

2625, 2799

2740, 2613

FS

Hose		Max. O.D.	Partek Sleeve	External Round Spring	Internal Round Spring	External Flat Spring	Internal Flat Spring	Fire Sleeve
919/929	-4	0.32	-	2625-11	-	2740-11	-	FS-F-5
	-5	0.40	-	2625-14	-	2740-14	-	FS-F-7
	-6	0.46	AS-Y-11/AS-B-11	2625-15	-	2740-16	-	FS-F-8
	-8	0.56	AS-Y-11/AS-B-11	2625-19	-	2740-19	2613-13CR	FS-F-10
	-10	0.66	AS-Y-13/AS-B-13	2625-22	-	2740-22	2613-16CR	FS-F-12
	-12	0.79	AS-Y-15/AS-B-15	2625-26	-	2740-26	2613-20CR	FS-F-14
939	-16	1.05	AS-Y-17/AS-B-17	2625-34	-	2740-34	2613-28CR	FS-F-20
	-20	1.32	AS-Y-22/AS-B-22	2625-44	-	2740-44	2613-37CR	FS-F-24
	-4	0.48	AS-Y-11/AS-B-11	2625-16	-	2740-18	-	FS-F-10
	-6	0.59	AS-Y-13/AS-B-13	2625-20	-	2740-20	-	FS-F-11
	-8	0.75	AS-Y-15/AS-B-15	2625-25	-	2740-25	-	FS-F-14
	-10	0.88	AS-Y-17/AS-B-17	2625-29	-	2740-30	-	FS-F-16
	-12	1.09	AS-Y-19/AS-B-19	2625-36	-	2740-36	-	FS-F-20
	-16	1.33	AS-Y-27/AS-B-27	2625-44	2799-16CR	2740-44	-	FS-F-24
	-20	1.75	AS-Y-35/AS-B-35	2625-58	2799-20CR	2740-58	-	FS-F-32
	-24	2.05	AS-Y-39/AS-B-39	2625-67	2799-24CR	2740-70	-	FS-F-38
943	-32	2.56	AS-Y-47/AS-B-47	2625-83	2799-32CR	2740-83	-	FS-F-48
	-6	0.49	AS-Y-11/AS-B-11	2625-17	-	2740-18	-	FS-F-10
	-8	0.62	AS-Y-13/AS-B-13	2625-21	-	2740-21	2613-13CR	FS-F-11
	-10	0.73	AS-Y-15/AS-B-15	2625-24	-	2740-23	2613-16CR	FS-F-14
	-12	0.99	AS-Y-17/AS-B-17	2625-33	-	2740-35	2613-20CR	FS-F-18
	-16	1.39	AS-Y-27/AS-B-27	2625-45	-	2740-46	2613-28CR	FS-F-24

NOTE:

Partek sleeves come in yellow and black.
All internal guards are fabricated from 300 series stainless steel.
All external guards are plated steel.

**WARNING**

This product can expose you to chemicals including Lead, which is known to the State of California to cause cancer and birth defects or other reproductive harm. For more information go to www.P65Warnings.ca.gov.

PSG – Parker Spiral Guard



Features

- High-strength and resilient, Spiral Guard protects hose and cable with superior anti-crush performance
- Exceptionally smooth facing and rounded edges prevent Spiral Guard from getting caught on rough surfaces
- Easy installation and routing
- Low friction interior minimizes wear on hose
- For bundling, organizing and protecting hose and cable, Parflex Spiral Guard is the superior solution for mining operations - In fact, it delivers more advantages than cut pipe or sleeving at a competitive price or less
- Spiral Guard is available in:
 - An MSHA/FRAS approved version for underground mining
 - A standard version (with yellow stripe) for surface applications not requiring fire-resistant, anti-static properties
- Manufactured with high density polyethylene materials

Applications



- Mining
- Automotive
- Mobile Equipment

Part Number	Hose O.D. Range		Package Qty.		1-Wire Braid Size		2-Wire Braid Size		Multi-Spiral Size		Weight	
	mm	inch	mtr.	feet	inch	mm	inch	mm	inch	mm	lbs./ft.	kg./mtr.
#	◎											
PSG 12	10 – 13	.394-.512	20	65.6	-		-		-		.034	.015
PSG 16 FRAS or PSG 16	12 – 17	.472-.669	20	65.6	1/4	6	1/4	6	-		.040	.018
PSG 20 FRAS or PSG 20	16 – 22	.630-.866	20	65.6	3/8	10	1/4 3/8	6 10	3/8	10	.060	.027
PSG 25 FRAS or PSG 25	22 – 28	.866-1.10	20	65.6	1/2 5/8	13 16	1/2 5/8	13 16	1/2 5/8	13 16	.101	.046
PSG 32 FRAS or PSG 32	27 – 33	1.06-1.30	20	65.6	3/4	19	5/8 3/4	16 19	5/8 3/4	16 19	.151	.068
PSG 40 FRAS or PSG 40	33 – 42	1.30-1.65	20	65.6	1	25	1	25	1	25	.235	.107
PSG 50 FRAS or PSG 50	42 – 55	1.65-2.17	20	65.6	1-1/4 1-1/2	32 38	1-1/4	32	1-1/4	32	.268	.122
PSG 63 FRAS or PSG 63	52 – 65	2.05-2.56	20	65.6	2	51	1-1/2	38	1-1/2	38	.402	.182
PSG 75 FRAS or PSG 75	65 – 80	2.56-3.15	10	32.8	-		2	51	2	51	.637	.289
PSG 90 FRAS or PSG 90	80 – 150	3.15-5.91	10	32.8	-		-		-		.771	.350
PSG 110 FRAS or PSG 110	150 – above	5.91-above	10	32.8	-		-		-		1.00	.454

Temperature Range: -148°F to 212°F (-100°C to 100°C)



WARNING

This product can expose you to chemicals including Lead, which is known to the State of California to cause cancer and birth defects or other reproductive harm. For more information go to www.P65Warnings.ca.gov.

Hose Assembly Instructions

Hose Selection, Installation
& Maintenance

Die Selection & Crimp Charts

Materials

Government Agency
& Specifications



Table of Contents

Hose Selection, Installation & Maintenance

Intro.....	G-3
Selection of Hose Diameter.....	G-4
Calculation of Hose Length.....	G-5
Volumetric Expansion of Hose.....	G-6
Hose Permeation Data (510A).....	G-8
Pressure Rating of Hose End Connections, Inch.....	G-9
Pressure Rating of Hose End Connections, Metric.....	G-10
Selection, Installation & Maintenance.....	G-11

Hose Assembly & Crimping Instructions

How To Use Crimpsource.....	G-14
Permanent Crimp, Series 54, 56, 92, CY, CG, MS, SF.....	G-15
MiniKrimp™ Assembly.....	G-18
Field Attachable, Series 51, BU & MS.....	G-21
PTFE Permanent Crimp, Series 91, 91N & 93N.....	G-23
PTFE Permanent Crimp, Series PAGE.....	G-26
PTFE Field Attachable, Series 90.....	G-28
Sewer Hose SQ-Swage Assembly Instructions.....	G-31
Twin/Multi-Line Separation.....	G-34

Technical Data

Die Selection & Swage Specification Chart (Sewer Hose).....	G-36
Hose Fitting Insertion Values.....	G-37
Hose Fitting Thread Guide.....	G-38
Media to Fitting & Seal Compatibility Guide.....	G-40
Metal Tube & Fitting Material Compatibility Guide.....	G-42
O-Ring Material Selection Guide.....	G-44
Metals Corrosion Scale.....	G-45
Materials to Parflex Part Number.....	G-46
Media to Hose Material Compatibility Guide.....	G-47
Media to Plastic Tubing Material Compatibility Guide.....	G-51
Metric Conversion Chart.....	G-54

Other

Government Agency & Specifications.....	G-55
Parker Safety Guide.....	G-56
ENERPAC Warranty.....	G-60
Offer of Sale.....	G-61
Part Number Index.....	i
Key Word Index.....	iv

General Technical Introduction

Hose Assembly Tutorial

Crimping

Steps for crimping are clearly marked with sequences showing product distinctions between products lines.

- Crimping section, as well as universal preparations, for all hoses appear first.
- Field Attachable assemblies appear next.

*The PARKRIMP crimping system is the same for all standard Parker portable or bench style crimpers.

Please note: You must become familiar with your own specific crimper to determine its operational features. Please review thoroughly and understand your operator’s manual included with your machine. Never use a crimper beyond its recommended published capacities. Crimp specifications are found online by accessing Crimp Source. www.parker.com/crimpsource

Twin/Multi-Line Hose

Review **twin/multi-line hose separation**, pg. G-34 if applicable – this will give you information before proceeding to the assembly pages – Not following this procedure may cause permanent damage to hoses.

Selection of Hose Diameter

Flow Capacities at Recommended Flow Velocities

The nomogram below is provided as an aid in determining the correct hose size.

How to use the nomogram: Determine the proper flow rate your system requires, then connect a straight edge from the selected flow rate to the recommended velocity range. The inside diameter required is shown in the center column at or above the straight edge. In this case, we need a hose I.D. of 0.625 (5/8") inch (or larger).

Example: Locate 16 gallons per minute in the left-hand column and 20 feet per second (fps) in the right-hand column (the maximum recommended velocity range for pressure lines). Lay a straight edge across these two points. The inside diameter required is shown in the center column at or above the straight edge. In this case, we need a hose I.D. of 0.625 (5/8") inch (or larger).

Use the same procedure for suction of return lines, except utilizing their respective maximum recommended velocities.

Flow Gallons per Minute

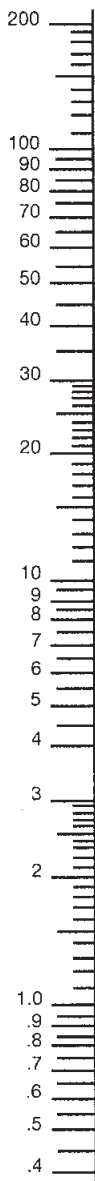

**Inside Diameter of Hose
Inch / Dash Size**
20, 21, 22, 23, All Others
Group XV, 90, 91

2-3/8"	40	32	2"
1-13/16"	32	24	1-1/2"
1-3/8"	24	20	1-1/4"
1-1/8"	20	16	1"
7/8"	16	12	3/4"
5/8"	12	10	5/8"
1/2"	10	8	1/2"
13/32"	8	6	3/8"
5/16"	6	5	5/16"
1/4"	5	4	1/4"
3/16"	4	3	3/16"

**Velocity
Feet per Second**

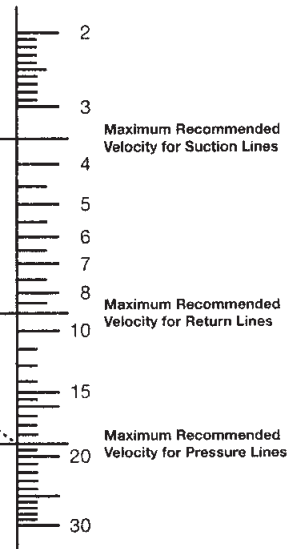

The nomogram is based on the following formula:

$$D = \sqrt{\frac{Q \times 0.4081}{V}}$$

Where: Q = Flow in Gallons per Minute (gpm)
V = Velocity in Feet per Second (ft/sec)
D = Hose Inside Diameter (inches)

Calculation of Hose Length For Over-the-Sheave Applications

The exact cutoff length for an optimum over-the-sheave assembly depends on the particular mechanical arrangement of the machine. A method for finding an approximate starting point is as follows:

1. Assemble hose with one coupling as shown in diagram.
2. Measure hose length from point 1 to point 2 with hose taut. LO = length
3. Calculation of insert allowance (x) may be found from the coupling dimension tabulations in the fittings section or from direct measurement on the coupling. A 1.5% stretch allowance is provided in the following formula.
4. Calculate hose cutoff hose cut length HCL:

$$HCL = 0.985 LO + 2X$$
 Where HCL includes coupling, insert allowance on both ends.
5. Couple the remaining hose end, check crimp, and assemble on the machine.

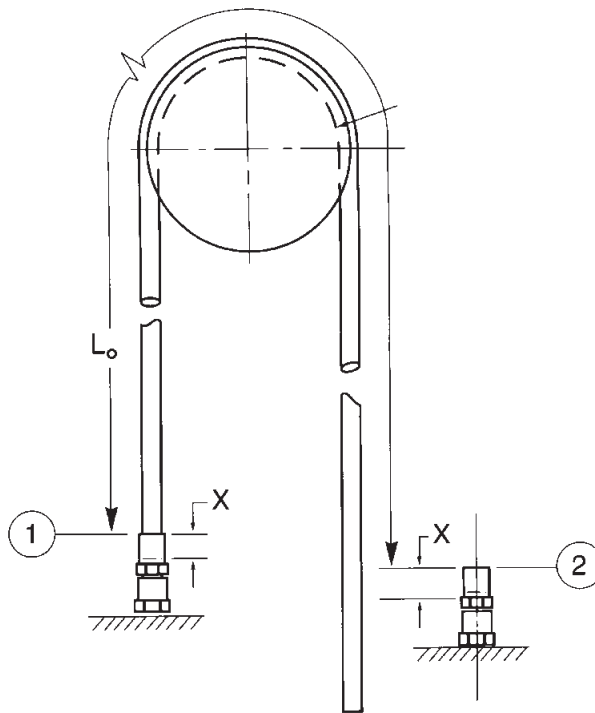

Volumetric Expansion of Hose

Hydraulic hoses expand under pressure. On some applications, customers can use the differences in expansion between hoses to tune systems for better performance or even noise reduction. Parflex has tested a select list of hoses and determined the rate of expansion in cubic centimeters per foot of hose (cc/ft).

To calculate the volumetric expansion of a hose, substitute the desired pressure into the "X" values in the appropriate equation. For other hoses, please contact the division.

Hose Part Number	Volumetric Expansion at Maximum Working Pressure		Equation for Volumetric Expansion
	(psi)	(cc/ft)	Y=(cc/ft) X=(psi)
510C-3	3250	2.33	Y=0.0007X+0.0581
510C-4	3000	2.71	Y=0.0009X+0.0059
510C-5	2500	3.41	Y=0.0013X+0.1647
510C-6	2250	4.32	Y=0.0019X+0.0471
510C-8	2250	7.36	Y=0.0032X+0.1637
510C-12	1250	8.99	Y = 0.00745x - 0.29910
510C-16	1000	15.33	Y = 0.01573x - 0.44928
518C-3	3250	2.33	Y=0.0007X+0.0581
518C-4	3150	2.71	Y=0.0009X+0.0059
518C-5	3150	3.41	Y=0.0013X+0.1647
518C-6	3000	4.32	Y=0.0019X+0.0471
518C-8	3000	7.36	Y=0.0032X+0.1637
518C-12	1660	8.99	Y = 0.00745x - 0.29910
518C-16	1330	15.33	Y = 0.01573x - 0.44928
520N-3/528N-3	5000	1.13	Y = 0.0002x + 0.1621
520N-4/528N-4	5000	2.05	Y = 0.00031x + 0.47589
520N-5/528N-5	4500	2.63	Y = 0.00048x + 0.48415
520N-6/528N-6	4000	2.87	Y = 0.00053x + 0.75151
520N-8/528N-8	3500	3.64	Y = 0.00086x + 0.64994
53DM-4	3000	1.90	Y = 0.00062x + 0.02373
53DM-6/538DM-6	3000	3.19	Y = 0.0010x + 0.0647
53DM-8	3000	4.68	Y = 0.0016x + 0.0384
53DM-10	3000	9.82	Y = 0.0033x - 0.2254
540N-2	3000	1.11	Y = 0.00036x + 0.04607
540N-3	3000	1.75	Y = 0.00057x + 0.03059
540N-4	2750	2.33	Y = 0.00079x + 0.14354
540N-5	2500	3.46	Y = 0.00124x + 0.31870
540N-6	2250	4.06	Y = 0.00174x + 0.15045
540N-8	2000	6.05	Y = 0.0030x + 0.0928
540N-12	1250	10.26	Y = 0.0081x - 0.2671
560TJ-3	3626	0.575	Y = 0.00017x + 0.00875

Volumetric Expansion of Hose (cont.)

A
Hose

B
Tubing

C
Coiled Air Hose & Fittings

D
Transportation

E
Fittings

F
Tooling, Equipment & Accessories

G
General Technical

Hose Part Number	Volumetric Expansion at Maximum Working Pressure		Equation for Volumetric Expansion
	(psi)	(cc/ft)	Y=(cc/ft) X=(psi)
560TJ-4	3263	0.757	Y = 0.0002x + 0.1172
560TJ-5	3118	0.729	Y = 0.00021x + 0.09887
560TJ-6	2750	1.33	Y = 0.0004x + 0.1918
560TJ-8	2500	1.98	Y = 0.0007x + 0.2093
560TJ-10	2000	3.04	Y = 0.0012x + 0.5704
560TJ-12	1750	3.07	Y = 0.0015x + 0.4449
575X-3	5000	1.69	Y = 0.0003x + 0.2119
575X-4	5000	2.05	Y = 0.0003x + 0.5601
575X-6	5000	2.71	Y = 0.0004x + 0.8412
575XN-8	5000	4.59	Y = 0.00064x + 1.41795
575X-12	5000	12.52	Y = 0.00192x + 2.92038
575X-16	5000	16.81	Y = 0.0028x + 2.9560
590TJ-4	5076	0.888	Y = 0.00016x + 0.09821
590TJ-6	4061	1.87	Y = 0.00038x + 0.32317
590TJ-8	3553	2.17	Y = 0.00049x + 0.43765
590TJ-12	2500	4.20	Y = 0.0013x + 0.8216
590TJ-16	2030	6.21	Y = 0.0026x + 1.0558
D6R04 / D6RX04	3000	2.71	Y = 0.0009x + 0.0059
D6R05	3000	1.28	Y = 0.0003x + 0.3834
D6R06 / D6RX06	3000	1.28	Y = 0.0003x + 0.3834
D6R08 / D6RX08	3000	2.88	Y = 0.00057x + 1.20744
D6R10	3000	2.08	Y = 0.00061x + 0.23127
D6R12	3000	5.53	Y = 0.00142x + 1.21743
D6R16	3000	7.33	Y = 0.00205x + 1.24905
H604	3000	1.80	Y = 0.00044x + 0.51607
H605	3000	1.35	Y = 0.00036x + 0.26536
H606	3000	2.00	Y = 0.0006x + 0.2892
H608	3000	2.88	Y = 0.00057x + 1.20744
H610	3000	2.08	Y = 0.00061x + 0.23127
H612	3000	5.53	Y = 0.00142x + 1.21743

Example: Find the volumetric expansion of 560-8 hose at 2000 psi

- From the chart, the appropriate equation would be:
Y=0.0007x + 0.2093
- Substituting:
Y=0.0007* (2000) + 0.2093
- Therefore the volumetric expansion "Y" equals
1.60 cc/ft @ 2000 psi

The actual volumetric expansion achieved is influenced by multiple variables including fluid properties, hose routing and application temperature. The volumetric expansion calculation is only a general guideline and must be verified by actual testing in the end-use application. No performance warranty in design is expressed or implied by this calculation. Parker recommends that the user review and understand all the precautions listed in the Parker Safety Guide for Selecting and Using Hose, Fittings and Accessories, bulletin BUL. 4400-B.1.

Hose Permeation Data

510A

Permeation Rate at 120°F (Pound per Linear Hose Foot per Year)

Hose Size	R12	R22	R507	R404A	R502	R134A
-3	-	.30	.08	.07	-	-
-4	-	.71	.15	.10	-	-

Permeation Rate at 212°F (Pound per Linear Hose Foot per Year)

Hose Size	R12	R22	R507	R404A	R502	R134A
-3	-	1.25	-	-	-	-
-4	.08	2.32	-	-	-	.07

Notes:

1. Data is for comparison only. Actual results may vary due to differences in application temperature and pressure.
2. Data is collected in highly controlled tests per UL1963.
3. Parker Safety Guide for Selecting and Using Hose, Tubing, Fittings and Related Accessories, Section 2.6:

Permeation: Permeation (that is, seepage through the Hose) will occur from inside the Hose to outside when Hose is used with gases, liquid and gas fuels, and refrigerants (including but not limited to such materials as helium, diesel fuel, gasoline, natural gas, or LPG). This permeation may result in high concentrations of vapors which are potentially flammable, explosive, or toxic, and in loss of fluid. Dangerous explosions, fires, and other hazards can result when using the wrong Hose for such applications.

The system designer must take into account the fact that this permeation will take place and must not use Hose if this permeation could be hazardous. The system designer must take into account all legal, government, insurance, or any other special regulations which govern the use of fuels and refrigerants. Never use a Hose even though the fluid compatibility is acceptable without considering the potential hazardous effects that can result from permeation through the Hose Assembly.

Permeation of moisture from outside the Hose to inside the Hose will also occur in Hose assemblies, regardless of internal pressure. If this moisture permeation would have detrimental effects (particularly, but not limited to refrigeration and air conditioning systems), incorporation of sufficient drying capacity in the system or other appropriate system safeguards should be selected and used.

Pressure Rating of Hose End Connections

Inch Fittings

The maximum dynamic working pressure of the hose assembly is the lesser of the rated working pressure of the hose and the end connections used.

PRESSURE RATINGS HOSE ASSEMBLIES - psi (MPa)

PRESSURE OF THE HOSE AND THE END CONNECTIONS USED

Hose End Connection Description	Part Number Codes	Inch Fittings										
		-2	-4	-5	-6	-8	-10	-12	-16	-20	-24	-32
		psi (MPa)	psi (MPa)	psi (MPa)	psi (MPa)	psi (MPa)	psi (MPa)	psi (MPa)	psi (MPa)	psi (MPa)	psi (MPa)	psi (MPa)
Male Pipe (NPTF)	01	12,000 (82.7)	12,000 (82.7)		10,000 (68.9)	10,000 (68.9)		7,500 (51.7)	6,500 (44.8)	5,000 (34.5)	3,000 (20.7)	2,500 (17.2)
Female Pipe (NPTF, NPSM)	02 & 07	7,500 (51.7)	7,000 (48.3)		6,000 (41.4)	5,000 (34.5)		4,000 (27.6)	3,000 (20.7)	2,500 (17.2)	2,000 (13.8)	2,000 (13.8)
Male Pipe (BSP)	91 & D9	5,000 (34.5)	9,000 (62.1)		8,000 (55.2)	6,250 (43.1)		5,000 (34.5)	4,000 (27.6)	3,500 (24.1)	3,000 (20.7)	3,000 (20.7)
Female Pipe (BSP)	92, B1, B2 & B4	5,000 (34.5)	9,000 (62.1)		8,000 (55.2)	6,250 (43.1)	5,500 (37.9)	5,000 (34.5)	4,000 (27.6)	3,500 (24.1)	3,000 (20.7)	3,000 (20.7)
Female Pipe (JIS)	FU, GU, MU & UT		5,000 (34.5)		5,000 (34.5)	5,000 (34.5)		4,000 (27.6)	3,000 (20.7)	2,500 (17.2)	1,500 (10.3)	1,500 (10.3)
O-Ring Swivel and 45° Flare	13, 1L, S2, 0G, 0L, 48, 08, 77 & 79		3,000 (20.7)	3,000 (20.7)	3,000 (20.7)	3,000 (20.7)	2,750 (19.0)	2,250 (15.5)	2,000 (13.8)	1,625 (11.2)	1,250 (8.6)	1,125 (7.8)
37° Flare and Straight Thread	03, 05, 06, 37, 39, 41, L7 & L9		6,000 (41.4)	6,000 (41.4)	5,000 (34.5)	5,000 (34.5)	5,000 (34.5)	5,000 (34.5)	4,000 (27.6)	3,000 (20.7)	2,500 (17.2)	2,500 (17.2)
Flare	04											
SAE Flareless	11 & 12		6,000 (41.4)	6,000 (41.4)	5,600 (38.6)	5,600 (38.6)	4,200 (29.0)	4,200 (29.0)	3,500 (24.1)	3,500 (24.1)	3,000 (20.7)	3,000 (20.7)
SAE Inverted Flare	28, 67 & 69		2,750 (19.0)	2,500 (17.2)	2,250 (15.5)	2,000 (13.8)						
Seal-Lok® (O-Ring Face Seal)	JM, JC, JS, JO, J1, J5, J7 & J9		6,000 (41.4)		6,000 (41.4)	6,000 (41.4)	6,000 (41.4)	6,000 (41.4)	6,000 (41.4)	4,000 (27.6)	4,000 (27.6)	
A-Lok®	TU, AL		6,000 (41.4)	6,000 (41.4)	5,600 (38.6)	5,600 (38.6)	4,200 (29.0)	4,200 (29.0)	3,500 (24.1)	3,500 (24.1)	3,000 (20.7)	3,000 (20.7)
Rapid Assembly	WU, WY, WW		2,000 (13.8)		1,500 (10.3)							

NOTE: All the above ratings are based on steel and stainless steel hose fittings. Parflex 106CG-16-16 / 106CG-16-16C is rated for 5000psi (34.5 Mpa) working pressure.

PRESSURE RATING OF HOSE - psi (MPa)

THE MAXIMUM WORKING PRESSURES OF HOSES ARE LISTED ON PAGE A-10 : A-17 WITH EACH HOSE DESCRIPTION IN SECTION A.

Hose
A

Tubing
B

Coiled Air Hose
& Fittings
C

Transportation
D

Fittings
E

It
F

Tool
Equ
& Accessories
F

General
Technical
G

Pressure Rating of Hose End Connections

Metric Fittings

The maximum dynamic working pressure of the hose assembly is the lesser of the rated working pressure of the hose and the end connections used.

PRESSURE RATINGS HOSE ASSEMBLIES - psi (MPa)

PRESSURE OF THE HOSE AND THE END CONNECTIONS USED

Hose End Connection	Part Number	Metric Fittings																	
		Description	Codes	-6	-8	-10	-12	-14	-15	-16	-18	-20	-22	-25	-28	-30	-35	-38	-42
				psi (MPa)	psi (MPa)	psi (MPa)	psi (MPa)	psi (MPa)	psi (MPa)	psi (MPa)	psi (MPa)	psi (MPa)	psi (MPa)	psi (MPa)	psi (MPa)	psi (MPa)	psi (MPa)	psi (MPa)	
DIN Light "L" without O-Ring	C3, C4, C5 & 1D			3,500 (24.1)	3,500 (24.1)	3,500 (24.1)	3,500 (24.1)		3,500 (24.1)		2,250 (15.5)		2,250 (15.5)		1,400 (9.7)		1,400 (9.7)		1,400 (9.7)
DIN Light "L" with O-Ring	D0, CA, CE & CF			4,500 (31.0)	4,500 (31.0)	4,500 (31.0)	4,500 (31.0)		4,500 (31.0)		2,250 (15.5)		2,250 (15.5)		2,250 (15.5)		2,250 (15.5)		2,250 (15.5)
DIN Heavy "S" without O-Ring	C6, C7, C8 & 3D				9,000 (62.1)	9,000 (62.1)	9,000 (62.1)	9,000 (62.1)		5,750 (39.6)		5,750 (39.6)		5,750 (39.6)		3,500 (24.1)		3,500 (24.1)	
DIN Heavy "S" with O-Ring	C9, 0C, 1C & D2				9,000 (62.1)	9,000 (62.1)	9,000 (62.1)	9,000 (62.1)		6,000 (41.4)		6,000 (41.4)		6,000 (41.4)		6,000 (41.4)		4,500 (31.0)	

NOTE: All the above ratings are based on steel and stainless steel hose fittings.

PRESSURE RATING OF HOSE - psi (MPa)

THE MAXIMUM WORKING PRESSURES OF HOSES ARE LISTED ON PAGE A-10 : A-17 WITH EACH HOSE DESCRIPTION IN SECTION A.

Selection, Installation & Maintenance

Recommended Practices for Hydraulic Hose Assemblies

wrong



The routing of the hose assembly and the environment in which the hose assembly operates directly influence the service life of the hose assembly. The following diagrams indicate the correct routing of hose assemblies that will maximize its service life and assure a safe working functionality.

When hose installation is straight, there must be enough slack in the hose to allow for changes in length that occur when pressure is applied. When pressurized, hose that is too short may pull loose from its hose fittings or stress the hose fitting connections, causing premature metallic or seal failures.

The hose length must be determined so that the hose assembly has enough slack to allow the system components to move or vibrate without creating tension in the hose.

However, do not allow too much slack and therefore introduce the risk of the hose snagging on other equipment or rubbing on other components.

Mechanical straining of the hoses needs to be avoided, so the hose must not be bent below its minimum bend radius or twisted during installation. The minimum bending radii for each hose is stated in the hose tables in the catalogue.

The plane of movement must also be considered and the hose routing selected accordingly.

Hose routing also plays an important role on the selection of the hose fittings, as the correct fittings can avoid straining the hoses, unnecessary hose length or multiple threaded joints.

right



Selection, Installation & Maintenance (cont.)

Recommended Practices for Hydraulic Hose Assemblies

wrong

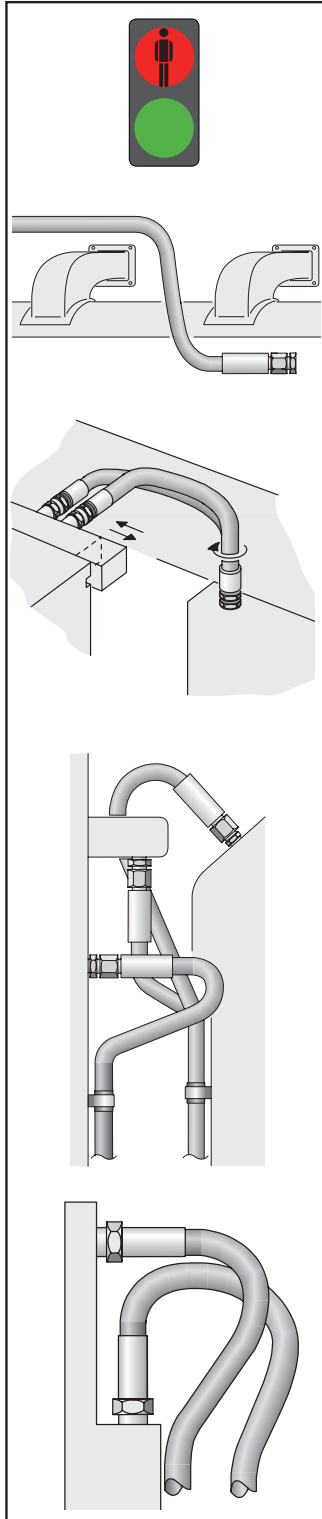

Correct clamping (holding/supporting) of the hose should be exercised to securely route the hose or to avoid the hose contacting surfaces that will cause the hose damage. It is however, vital that the hose be allowed to keep its functionality as a “flexible-pipe” and not be restricted from changing in length when under pressure.

It should also be noted that hoses for high- and low-pressure lines shall not be crossed or clamped together, as the difference in changes in length could wear the hose covers.

Hose should not be bent in more than one plane. If hose follows a compound bend, it shall be coupled into separate segments or clamped into segments that each flex in only one plane.

Hoses should be kept away from hot parts as high ambient temperatures shorten hose life. Protective insulation may need to be used in unusually high ambient temperature areas.

While the importance of the functionality is primary, the aesthetics and practicality of the installation should also be considered in the design.

Maintenance might be necessary at some point in the future, so prohibitive design routings should be avoided.

right

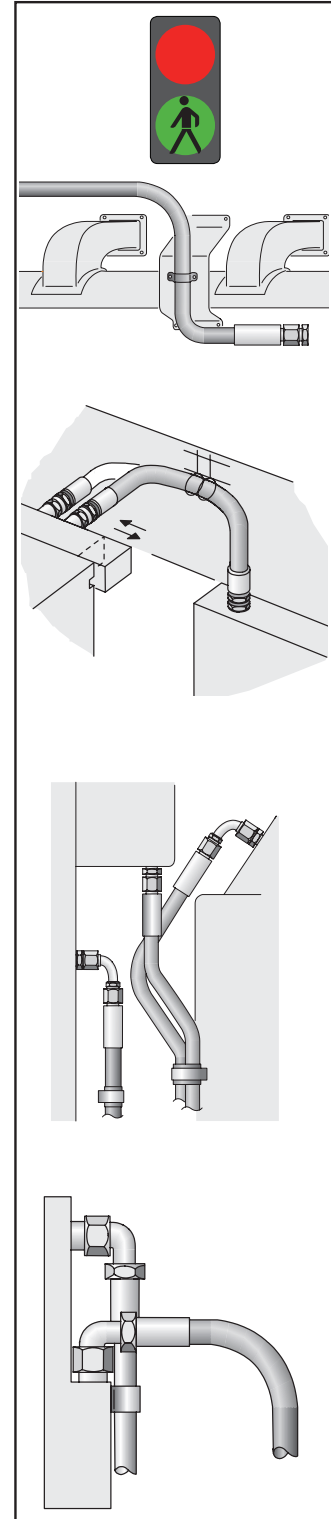

Selection, Installation & Maintenance (cont.)

Recommended Practices for Hydraulic Hose Assemblies

wrong

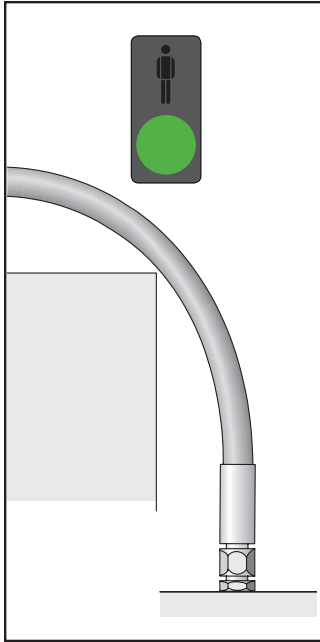

Abrasive influences

In general care should be taken so that the hose is not exposed to direct surface contact that will cause abrasive wearing of the outer cover (either hose to object or hose to hose contact). If however, the application is such that this cannot be avoided, either a hose with a higher abrasion resistant hose cover or a protective sleeve need to be used.

right

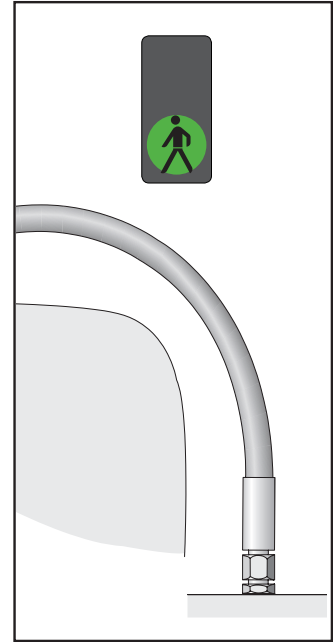

Hose Assembly and Crimping

How To Use Crimpsource

1

Data



The most **up-to-date** information for crimping is located at www.parker.com/crimpsource. Not only is it accurate, but it is easy.

NOTE: If the hose does not come up, then you cannot crimp that hose on the machine you selected.

If the fitting you choose doesn't come up, then that series is not available for that hose. Same with size.

2

Make your Selections

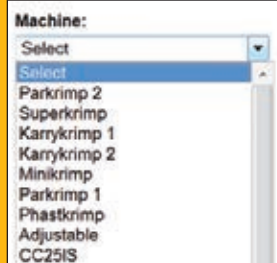

Choose the correct machine.

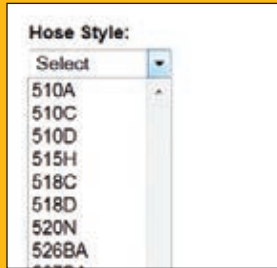

Choose the hose you are crimping.

Note If the hose does not come up, then the crimper chosen does not work with the selected hose.

3

Make your Selections

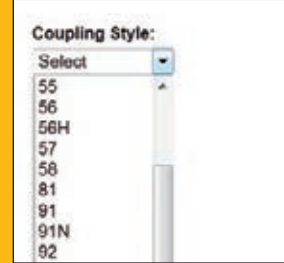

Choose the fitting style.

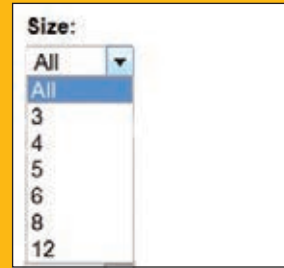

Choose the fittings size. Once you have selected values from each field, hit the search button.

Note If the chosen fitting/size doesn't come up, the series/size is not available for that hose.

4

Review The Results

Hose Style: 540N	Coupling Style: 56	Crimper: Minikrimp	Hose Description	Meets or exceeds SAE 100R7			
Size	Die	Die Ring	Crimp Diameter	Crimp Length	Hose Insertion	Drawing	
Parker Parflex Crimp Dies							
-8	80C-P08		82C-R01	0.850	FULL	1-1/8	PKFull
Comments							
PFD: Crimp diameter is measured four places, 45 degrees apart, at the top, then middle and bottom of the crimp.							
PFD: Crimp diameter tolerance on all Parkrimp Crimpers is $\pm 0.010"$ ($\pm 0.25\text{mm}$) unless otherwise specified. Crimp length tolerance is $\pm 0.030"$ ($\pm 0.76\text{mm}$).							
PFD: Align measurement caliper or micrometer on the center of crimp impressions avoiding the crimp ribs.							
PFD: Crimp diameter tolerance on all Adjustable Crimpers is $\pm 0.005"$ ($\pm 0.13\text{mm}$). Crimp length tolerance is $\pm 0.030"$ ($\pm 0.76\text{mm}$).							
PFD: Reference Parker Fluid Connector Group (FCG) Safety Bulletin 4400-B.1 (www.parker.com/safety)							

PKFull
CRIMP LENGTH
CRIMP DIAMETER
PARKRIMP DIE

Hose Assembly and Crimping

Permanent Crimp

Series 54, 56, CG, 92, CY, MS, SF

CAUTION: There are several different sections for Hose Assembly and Crimping. Be sure you are in the section that corresponds to the fitting series you are using. See Table of Contents for listing.

1

Inspection



Hose – Visually inspect both ends of hose for square cut. Remove any burrs, loose fibers or wires.



Fittings – Verify fitting series corresponds to the selected hose. Visually inspect fitting(s) for a through-hole, threads and damage.

2

Assembly Prep



Insertion Depth – Shown is a 56 Series fitting. See Hose Fitting Insertion Values, pg. G-37 for insertion depths of fitting series that do not incorporate an insertion depth. Mark hose end with proper insertion depth line.



Lubrication (as required) – Using an SAE 20 weight lubricating oil, lightly lubricate inside of hose end.

Warning

Do not use lubricating oil when installing fittings on hose used in oxygen service. When installing fittings on hose used in oxygen service, lubricate with a non-oil based soap solution. Failure to do so may result in an explosion and personal injury when hose is used.

3

Assembly



Assemble hose – Push hose into fitting all the way to depth insertion mark. (If fitting does not readily slide onto hose, perform the next step.)



Using Parker VBS or VBL (vise blocks) and a rubber mallet, tap fitting onto hose until bottom of fitting shell is aligned with depth insertion mark.

A
Hose

B
Tubing

C
Coiled Air Hose
& Fittings

D
Transportation

E
Fittings

F
Tooling,
Equipment
& Accessories

G
General
Technical

Hose Assembly and Crimping (cont.)

Permanent Crimp

Series 54, 56, CG, 92, CY, MS, SF

4

Die Selection



Select proper Parkrimp die set. (Reference Crimp Die Selection on Crimpsource online at www.parker.com/crimpsource)

6

Die & Spacer Ring

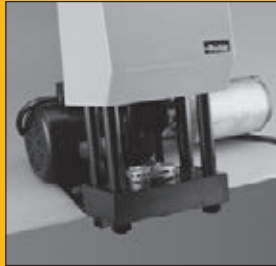

Crimp Die – Place die set into bowl.



Die Ring – Place applicable die ring on top of die. Position ring so it is centered on die.

(Reference Crimp Die Selection on Crimpsource online at www.parker.com/crimpsource)

7

Crimp



Assemble hose – Insert hose and fitting from bottom of crimper and up through die set. Position fitting so bottom of fitting skirt rests on die step (PARKALIGN® feature).

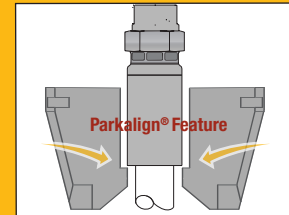

While holding hose and fitting in position on die step, crimp fitting onto hose until die ring contacts base plate.

Warning

Keep fingers and hands away from die-pusher area. Failure to do so may result in personal injury.

Note

Pump on crimper must not exceed the rated pressure of the crimper being used. Parker Hannifin will not accept responsibility for the operation of or provide warranty coverage for a crimper that is operated by a power unit other than equipment supplied by Parker Hannifin for the express purpose of operating the crimper.

5

Lubricate Bowl



Grease frequently using a premium, quality, lithium-base grease. Apply a thin layer of grease on bowl of crimper base plate.

Hose Assembly and Crimping (cont.)

Permanent Crimp

Series 54, 56, CG, 92, CY, MS, SF

8

Measure & Inspect



Measure and verify hose assembly length.



Inspect insertion depth mark at fitting ends. Insertion mark must be visible but not exceed 1/8" from end of crimped fitting shell.



Measure crimp diameter of each fitting at top, middle and bottom of shell. Take measurements at a minimum of three places around shell circumference. Verify crimp diameter is within tolerances.

(Reference Crimp Die Selection on Crimpsource online at www.parker.com/crimpsource)

Hose
A

Tubing
B

Coiled Air Hose
& Fittings
C

Transportation
D

Fittings
E

Tooling,
Equipment
& Accessories
F

General
Technical
G

MiniKrimp™ Fitting Assembly Procedures

Permanent Crimp

Series 54, 56, CG, 92, CY, MS, SF

CAUTION: There are several different sections for Hose Assembly and Crimping. Be sure you are in the section that corresponds to the fitting series you are using. See **Table of Contents** for listing.

1

Inspection



Hose – Visually inspect both ends of hose for square cut. Remove any burrs, loose fibers or wires.



Fittings – Verify fitting series corresponds to the selected hose. Visually inspect fitting(s) for a through-hole, threads and damage.

2

Assembly Prep



Insertion Depth – Mark hose end with proper insertion depth line. See Hose Fitting Insertion Values, pg. G-37 for insertion depths of fitting series that do not incorporate an insertion depth.



Lubrication (as required) – Using an SAE 20 weight lubricating oil, lightly lubricate inside of hose end.

Warning

Do not use lubricating oil when installing fittings on hose used in oxygen service. When installing fittings on hose used in oxygen service lubricate with a non-oil based soap solution. Failure to do so may result in an explosion and personal injury when hose is used.

3

Assembly



Assemble hose – Push hose into fitting all the way to depth insertion mark. (If fitting does not readily slide onto hose, perform the next step.)



Using Parker VBS or VBL (vise blocks) and a rubber mallet, tap fitting onto hose until bottom of fitting shell is aligned with depth insertion mark.

MiniKrimp™ Fitting Assembly Procedures (cont.)

Permanent Crimp

Series 54, 56, CG, 92, CY, MS, SF

4

Die Selection

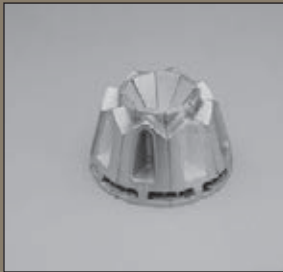

Select proper Parkrimp die set. (Reference Crimp Die Selection on Crimpsource online at www.parker.com/crimpsource)

5

Lubricate Bowl



Remove pusher from shoulder bolt.

Using a premium, quality, lithium-base grease, apply a thin layer of grease on bowl of crimper base plate.

[Take me to the video](#)

6

Die & Spacer Ring

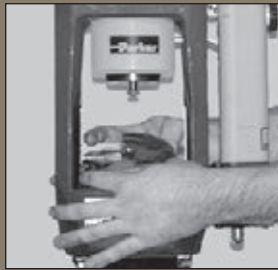

Crimp Die – Place die set into bowl.



Die Ring – Place applicable die ring on top of die. Position ring so it is centered on die.

(Reference Crimp Die Selection on Crimpsource online at www.parker.com/crimpsource)



Replace pusher onto shoulder bolt.

7

Crimp



Assemble hose – Insert hose and fitting from bottom of crimper and up through die set. Position fitting so bottom of fitting skirt rests on die step (PARKALIGN® feature).

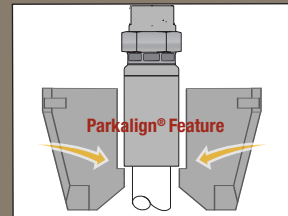

While holding hose and fitting in position on die step, crimp fitting onto hose until die ring contacts base plate.

Warning

Keep fingers and hands away from die-pusher area. Failure to do so may result in personal injury.

Note

Parker Hannifin will not accept responsibility for the operation of or provide warranty coverage for a crimper that is operated by a power unit other than equipment supplied by Parker Hannifin for the express purpose of operating the crimper.

Hose
A

Tubing
B

Coiled Air Hose
& Fittings
C

Transportation
D

Fittings
E

Tooling,
Equipment
& Accessories
F

General
Technical
G

MiniKrimp™ Fitting Assembly Procedures (cont.)

Permanent Crimp

Series 54, 56, CG, 92, CY, MS, SF

A Hose

B Tubing

C Coiled Air Hose & Fittings

D Transportation

E Fittings

F Tooling, Equipment & Accessories

G General Technical

8

Measure & Inspect



Measure and verify hose assembly length.



Inspect insertion depth mark at fitting ends. Insertion mark must be visible but not exceed 1/8" from end of crimped fitting shell.

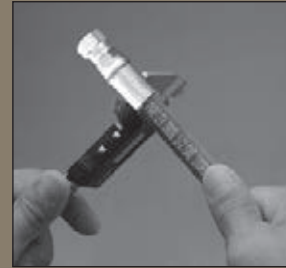

Measure crimp diameter of each fitting at top, middle and bottom of shell. Take measurements at a minimum of three places around shell circumference. Verify crimp diameter is within tolerances.

(Reference Crimp Die Selection on Crimpsource online at www.parker.com/crimpsource)

Hose Assembly and Crimping Field Attachable

Series 51, BU & MS (Do not use these fittings on oxygen service lines)

CAUTION: There are several different sections for Hose Assembly and Crimping. Be sure you are in the section that corresponds to the fitting series you are using. See Table of Contents for listing.

1

Inspection



Hose – Visually inspect both ends of hose for square cut. Remove any burrs, loose fibers or wires.



Fittings – Inspect socket for damaged or missing threads. Do not use if conditions exist.



Inspect nipple for a through-hole, damaged or missing threads and improperly crimped nut (if applicable). Do not use if these conditions exist.

2

Assembly



Using the Parker VBS or VBL vise block, place hose in proper hole of the vise block and then clamp in a bench vise. Ensure enough hose extends from the vise block to install socket.

Caution

Ensure hose is installed in correct size hole of vise block. Clamping hose in a smaller hole will crush hose.

3

Assembly



Using a wrench, screw socket onto hose counterclockwise until it bottoms. Ensure end of hose is against inside shoulder. Back off socket 1/4 turn clockwise.

Socket should be firm when tightened but not difficult to turn. If socket is difficult to install, apply lubricant that is compatible with the hose material.

Note

Do not use a lubricant with MS series.

Hose
A

Tubing
B

Coiled Air Hose
& Fittings
C

Transportation
D

Fittings
E

Tooling,
Equipment
& Accessories
F

General
Technical
G

Hose Assembly and Crimping (cont.)

Field Attachable

Series 51, BU & MS (Do not use these fittings on oxygen service lines)

A Hose

B Tubing

C Coiled Air Hose & Fittings

D Transportation

E Fittings

F Tooling, Equipment & Accessories

G General Technical

4

Assembly



Place hex portion of socket into vise and tighten vise. Ensure socket extends past vise jaws enough to allow for installation of nipple.

Caution

When tightening socket in vise, do not over tighten vise jaws. Over tightening vise jaws will distort internal threads of socket and hamper installation of nipple.

5

Assembly



Using an SAE 20 weight lubricating oil, generously lubricate nipple and socket, threads and hose I.D.

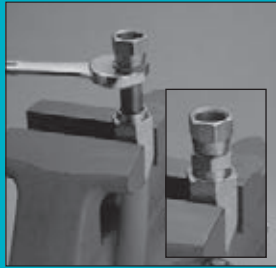

Using a wrench on the nipple hex, screw nipple into socket clockwise until nipple bottoms against socket shoulder.

Caution

Nipple should be firm when tightened but not difficult to turn. If nipple is difficult to install, check hose for proper lubrication. Re-apply lubricating oil as necessary. Installation of nipple without proper lubrication will damage core tube.

6

Inspection



Measure and verify hose assembly length.

Hose Assembly and Crimping

PTFE Permanent Crimp

Series 91, 91N & 93N

CAUTION: There are several different sections for Hose Assembly and Crimping. Be sure you are in the section that corresponds to the fitting series you are using. See Table of Contents for listing.

1

Cut



Using a power hose cutoff saw, cut hose squarely.

Note

PTFE Hose should be taped prior to cutting. Hose should be cut at center point of taped section.

2

Inspection



Hose – Visually inspect both ends of hose for square cut. Remove any burrs, loose fibers or wires.



Fittings – Verify fitting series corresponds to the selected hose. Visually inspect fitting(s) for a through-hole, threads and damage.

3

Assembly Prep



Insertion Depth – Mark hose end with proper insertion depth line. See Hose Fitting Insertion Values, pg. G-37 for insertion depths of fitting series that do not incorporate an insertion depth. For jacketed PTFE hoses, use a sharp knife and light pressure to cut back the cover at least the length of the insertion depth of the fitting.

Warning

Do not use lubricating oil when installing fittings on hose used in oxygen service. When installing fittings on hose used in oxygen service, lubricate with a non-oil based soap solution. Failure to do so may result in an explosion and personal injury when hose is used.



Assemble hose – Push fitting onto hose slightly and then remove tape. Continue pushing fitting onto hose until fitting reaches depth insertion mark.

Hose
A

Tubing
B

Coiled Air Hose
& Fittings
C

Transportation
D

Fittings
E

Tooling,
Equipment
& Accessories
F

General
Technical
G

Hose Assembly and Crimping (cont.)

PTFE Permanent Crimp

Series 91, 91N & 93N

4

Die Selection



Select proper Parkrimp die set. (Reference Crimp Die Selection on Crimpsource online at www.parker.com/crimpsource)

6

Die & Spacer Ring



Crimp Die – Place die set into bowl.



Die Ring – Place applicable die ring on top of die. Position ring so it is centered on die.

(Parflex hoses utilize silver die ring with the exception of HTB hose. Reference Crimp Die Selection on Crimpsource online at www.parker.com/crimpsource)

7

Crimp



Assemble hose – Insert hose and fitting from bottom of crimper and up through die set. Position fitting so bottom of fitting skirt rests on die step (PARKALIGN® feature).

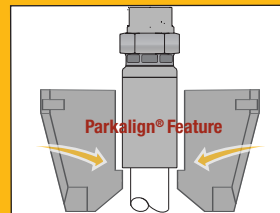

While holding hose and fitting in position on die step, crimp fitting onto hose until die ring contacts base plate.

Warning

Keep fingers and hands away from die-pusher area. Failure to do so may result in personal injury.

Note

Pump on crimper must not exceed the rated pressure of the crimper being used. Parker Hannifin will not accept responsibility for the operation of or provide warranty coverage for a crimper that is operated by a power unit other than equipment supplied by Parker Hannifin for the express purpose of operating the crimper.

5

Lubricate Bowl



Using a premium, quality, lithium-base grease, apply a thin layer of grease on bowl of crimper base plate.

Hose Assembly and Crimping (cont.)

PTFE Permanent Crimp

Series 91, 91N & 93N

8

Measure & Inspect



Measure and verify hose assembly length.



Inspect insertion depth mark at fitting ends. Insertion mark must be visible but not exceed 1/8" from end of crimped fitting shell.



Measure crimp diameter of each fitting at top, middle and bottom of shell. Take measurements at a minimum of three places around shell circumference. Verify crimp diameter is within tolerances.

(Reference Crimp Die Selection on Crimpsource online at www.parker.com/crimpsource)

Hose
A

Tubing
B

Coiled Air Hose
& Fittings
C

Transportation
D

Fittings
E

Tooling,
Equipment
& Accessories
F

General
Technical
G

Hose Assembly and Crimping

PTFE Permanent Crimp

Series PAGE Fittings

CAUTION: There are several different sections for Hose Assembly and Crimping. Be sure you are in the section that corresponds to the fitting series you are using. See Table of Contents for listing.

1

Inspection/Marking

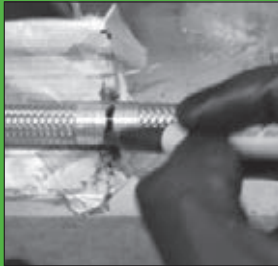

Obtain correct hose, fittings and collars per customer order. Inspect to make certain no defects are present on fittings, collars or hose.

Using 1" wide filament tape, apply 1 to 1½ wraps of tape tightly around hose at location to be cut. Mark tape in the middle where cut will be made. Tape will be left on during crimping so only ½" width of tape should remain.

Fittings – Inspect each component for possible damage. In addition, inspect socket and nipple for a through-hole and threads.

2

Cutting



Blow ends of hose off / out to remove any debris left from cutting operation. Cut off wires or fabric extending past the end of the hose.

3

Assembly



PAGE series fittings are not one piece but two pieces (insert plus collar) and must be properly installed to assure leak free long life assemblies.

Hose Assembly and Crimping (cont.)

PTFE Permanent Crimp

Series PAGE Fittings

Hose
A

Tubing
B

Coiled Air Hose
& Fittings
C

Transportation
D

Fittings
E

Tooling,
Equipment
& Accessories
F

General
Technical
G

4

Assembly



a. Orient and place collar on hose end fully.

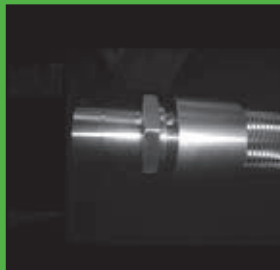

b. Using a taper punch, push punch into tube to enlarge bore of hose so insert just slides into hose.

c. Push insert into hose until lock groove of insert is just at end of collar.

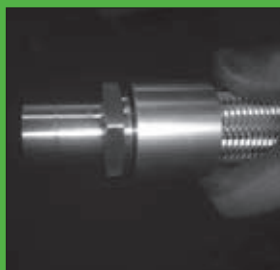

d. Pull collar out towards end of insert until at correct crimp position on insert of collar.

5

Assembly

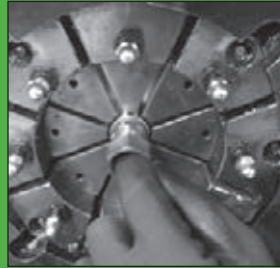

Crimp assembly only in Parker Approved adjustable crimper. Select correct die and crimp spec from Parker Crimp Source.

www.parker.com/crimpsource

a. Place assembly into crimp dies so full collar length crimp is obtained.

b. Check crimp dimensions in four places around the middle of the crimp circumference. Verify the average of those readings is within crimp specification tolerances. Adjust crimper up or down if needed to obtain proper dimension.

c. Crimp opposite end following the same procedures.

Warning

Keep fingers and hands away from die-pusher area. Failure to do so may result in personal injury.

6

Inspect



Inspect assembly, noting the length.

a. Test to correct test pressures to assure no leaks are observed using hydrostatic pressure unit (recommended). Air or nitrogen under water can be used with caution utilizing the proper pressure and procedures for that equipment.

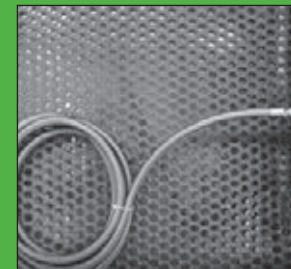

Blow out all water from the assembly and recheck length.

**Note any movement of length and make compensations as needed on next assembly.

Package assembly appropriately for customer requirements.

Hose Assembly and Crimping

PTFE Field Attachable

Series 90

CAUTION: There are several different sections for Hose Assembly and Crimping. Be sure you are in the section that corresponds to the fitting series you are using. See Table of Contents for listing.

1

Inspection

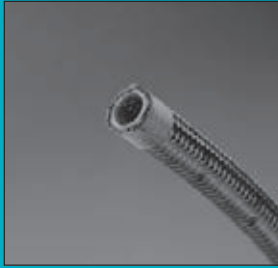

Hose – Visually inspect both ends of hose for square cut. Remove any burrs, loose fibers or wires.



Fittings – Inspect each component for possible damage. In addition, inspect socket and nipple for a through-hole and threads.

2

Assembly



Slide two sockets over end of hose with bottom of sockets back to back. Position sockets at each end of hose.

Note

When installing sockets on hose, check hose ends to determine if wire braid “necks down” (bends inward). If one end “necks down” use this end to slide sockets onto hose.

3

Assembly



Mount nipple hex in vise. Ensure nipple end extends beyond vise jaws sufficiently to allow installation of hose.



Push hose bore onto nipple to size tube and to aid in separating ferrule onto hose.

Once completed, remove hose from nipple.

Hose Assembly and Crimping (cont.)

PTFE Field Attachable

Series 90

4

Assembly



By hand, push sleeve over end of PTFE core tube and under wire braid.

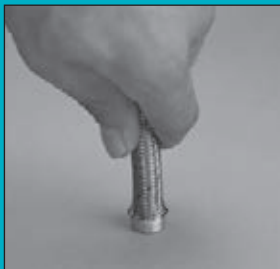

To complete positioning of sleeve, push hose end with sleeve against a solid flat surface.

5

Assembly



Verify tube butts against inside shoulder of ferrule.

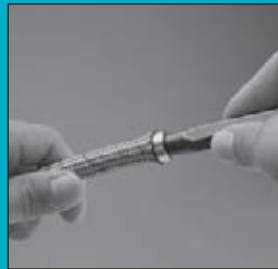

Using a tapered punch, push punch into end of sleeve and tube to set sleeve barbs into tube.

6

Assembly



Using SAE 20 weight oil, lubricate nipple and socket threads. For stainless steel fittings use Parker ThreadMate® or a molybdenum type lubricant.

Warning

Do not use lubricating oil when installing fittings on hose used in oxygen service. When installing fittings on hose used in oxygen service lubricate with a non-oil based soap solution. Failure to do so may result in an explosion and personal injury when hose is used.



Assemble hose – Using a twisting motion, push hose over nipple until hose is seated against nipple chamfer.

Hose
A

Tubing
B

Coiled Air Hose
& Fittings
C

Transportation
D

Fittings
E

Tooling,
Equipment
& Accessories
F

General
Technical
G

Hose Assembly and Crimping (cont.)

PTFE Field Attachable

Series 90

7

Assembly



Push socket forward and hand-start threading of socket to nipple.

Caution

When tightening socket in vise, do not over tighten vise jaws. Over tightening vise jaws will distort internal threads of socket.



Remove assembly from vise and reposition with socket in vise jaws. Ensure socket extends beyond vise jaws far enough to allow nipple to be completely tightened.

8

Assembly



Wrench tighten nipple hex until clearance between hex and socket hex is 1/32" or less.

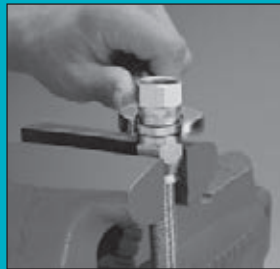

Tighten further to align corners of nipple and socket hexes if necessary.

9

Measure & Inspect

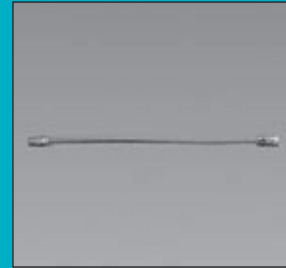

Measure and verify hose assembly length.

SQ-Swage Instructions

Sewer Hose

CAUTION: There are several different sections for Hose Assembly and Crimping. Be sure you are in the section that corresponds to the fitting series you are using. **See Table of Contents for listing.**

1

Inspection



Hose – Visually inspect both ends of hose for square cut. Remove any burrs, loose fibers or wires.



Fittings – Visually inspect fitting for properly crimped shells, internal barbs, a through-hole and damage.

2

Assembly



Insertion Depth – Mark hose end with proper insertion depth line.



Lubricate – Using an SAE 20 weight oil, lightly lubricate inside of both hose ends.



Assemble hose – Push each hose end into fitting to the depth insertion mark.

3

Assembly



Remove both die securing bolts and nuts.

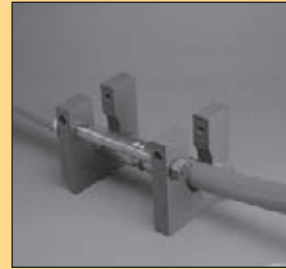

Place hose and fitting assembly into position on swager.

Hose
A

Tubing
B

Coiled Air Hose
& Fittings
C

Transportation
D

Fittings
E

Tooling,
Equipment
& Accessories
F

General
Technical
G

SQ-Swage Instructions (cont.)

Sewer Hose

4

Assembly



Insert both die halves around hose in each end of swager.



Install both die securing bolts with nuts positioned in opening of swager plates. Tighten die securing bolts 1/4 turn past finger tight.

5

Assembly



Lubricate - Using SAE 20 oil, generously lubricate the steel fitting surface and ID of the swage dies.

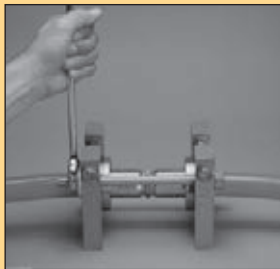

Assemble hose - Align swager plates in parallel and tighten nuts on swaging bolts uniformly until dies touch.

Caution

Ensure swager plates remain in parallel when tightening swager bolts. Failure to do so will result in an improperly swaged fitting.

Generously lubricate swaging bolts. Failure to do so may result in an improperly swaged fitting.

6

Assembly

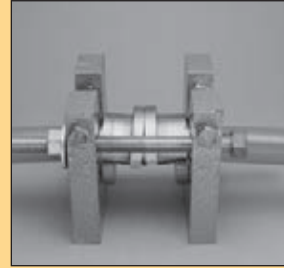

Loosen swaging bolts to release pressure on dies.



Remove die securing bolts and nuts. Then remove dies.

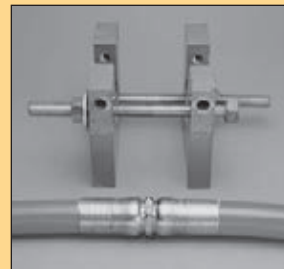

Assemble hose - Remove completed hose assembly.

SQ-Swage Instructions (cont.)

Sewer Hose

7

Measure & Inspect

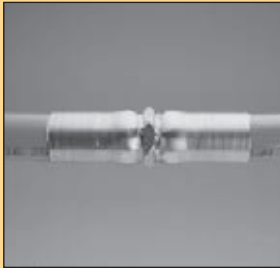

Measure and verify hose assembly length.

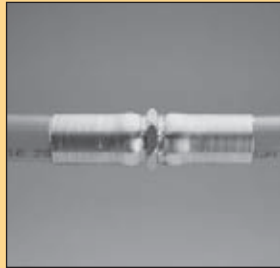

Inspect insertion depth mark at fitting ends. Insertion mark must be visible but not exceed 1/8" from end of crimped fitting shell.



Measure swage diameter of each fitting at top, middle and bottom of shell. Take measurements at a minimum of three places around shell circumference. Verify swage diameter is within tolerances.

(Reference Swage Specification & Tool Selection Chart on pg. G-37 for proper swage diameters.)

Twin/Multi-Line Separation

Factory-built assemblies are available using twin/multi-line hoses. When field-built assemblies are preferred, the following steps must be taken.

1

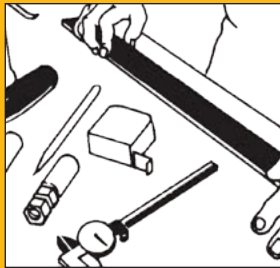

Set-Up – Position twinned or multi-line hose assembly so that it lies flat on work surface without tendency to twist or turn.

2

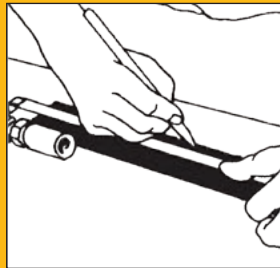

Measure hose to length – Measure and mark the length that the hoses are to be separated (commonly referred to as Splitback Length).

3

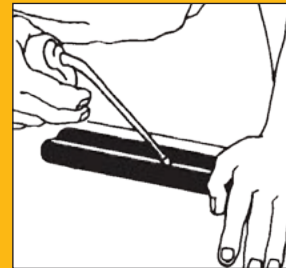

Lubricate – Lightly lubricate the web area between the hoses. Distribute the lubricant uniformly along the web of the assembly to be separated. Any lightweight oil will suffice (SAE 10 or 20). The function of the oil is to reduce the friction of the knife blade so that it naturally seeks the center of the valley formed by the hoses. This eliminates the need for the operator to steer the knife.

Twin/Multi-Line Separation (cont.)

4

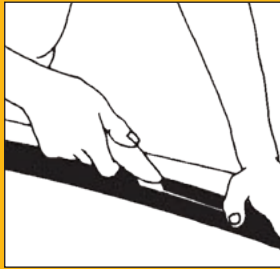

Cut Hose to Length – Press the multi-line hose assembly firmly and flat against the work surface with your free hand so that it does not move. Using a sharp utility knife, carefully draw the knife toward you with constant light to moderate pressure, and a smooth stroke. Multiple strokes will be necessary to separate the hoses.

Note

It is important that the knife blade be perpendicular to the hose during this procedure so that the blade cuts only the center line of the web. Extreme care must be taken to avoid cutting through the cover of the hoses and thereby exposing the hose reinforcement. If this occurs, the hose assembly must be discarded (See Figure 1). If the separation length is greater than that which can be accomplished with one continuous, smooth stroke, then the procedure should be repeated over shorter distances always cutting toward the free end of the hoses.

5

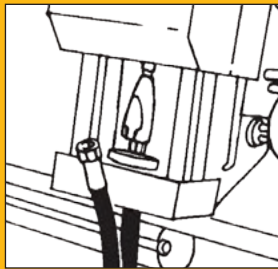

Measure Separation – It is suggested that the separation length be sufficiently long so that the swaging or crimping operation can be accomplished without risk of kinking the hoses or tearing the web which could result in exposure of the hose reinforcement (See Figure 2).

6



Apply Tape – At the option of the assembler, as dictated by the installation, a nylon lashing strap or tape may be applied at the termination of the separated length to provide protection against tearing of the web or hose covers.

INCORRECT HANDLING



Figure 1 – Extreme care must be taken to avoid cutting through the cover of the hoses and thereby exposing the hose reinforcement. If this occurs, the hose assembly must be discarded.

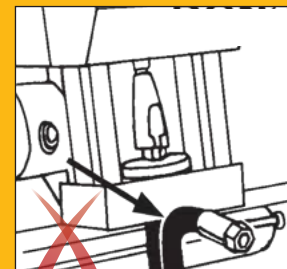

Figure 2 – The separation length must allow for the swaging or crimping operation without damaging the hose.

Die Selection & Swage Specification Chart

Sewer Hose

Swage Data For Sewer Cleaning Hose (SQ-101-SW SWAGE MACHINE ONLY)								
Hose Type	Hose I.D.	Male Pipe			Mender/Splicer		Swage O.D. +/- .015	Swage Length
		Fitting P/N	Die P/N	Pusher P/N	Fitting P/N	Die P/N		
	inch						inch	inch

S508N	1/2	-	-	-	1HU55-8-8	SQ-101-08S5S	0.850	0.750
S612	3/4	101SQ-12-12	SQ-101-12S6/S9	SQ-101-12P	1HUSQ-12-12	SQ-101-12S6/S9	1.172	1.109
S616	1	101SQ-16-16	SQ-101-16S6	SQ-101-16P	1HUSQ-16-16	SQ-101-16S6	1.445	1.156
S912	3/4	101SQ-12-12	SQ-101-12S6/S9	SQ-101-12P	1HUSQ-12-12	SQ-101-12S6/S9	1.172	1.109
S916	1	101SQ-16-16	SQ-101-16S9	SQ-101-16P	1HUSQ-16-16	SQ-101-16S9	1.488	1.156

Comments:

- Two dies required when swaging a mender/splicer fitting. A pusher is not required when swaging a mender/splicer fitting.
- One die and one pusher required when swaging a male pipe fitting.
- End fittings cannot be swaged on S5N series hose. Only mender/splicers can be swaged.

The information covered in the Swage Specification & Tool Selection Chart pertains to steel hose fittings. Swage diameter roundness shall not vary by more than .010". Swage diameters are measured in the center to the crimp area. Parflex Division reserves the right to alter swage specifications.

Hose Fitting Insertion Values

Inch & Metric

Hose
A

Inch												
Hose Dash Size	51	54	56	CG	91N	92	93N	BU	CY	LV/LH	MS Reusable	MS Permanent
-2			5/8					1/2	1/2			
-3	13/16	5/8	5/8	29/32	7/16	9/16		13/16	13/16	13/16		
-4	15/16	3/4	15/16	1-3/16	1/2							
-5	15/16	7/8	1		9/16						11/16	11/16
-6	1-5/16	15/16	1	1-5/16	5/8		7/16				15/16	3/4
-8	1-19/32	15/16	1-1/8	1-9/16	11/16		7/16			2-1/8		
-10			1-1/8		11/16		3/4			2-1/4		
-12	1-13/16		1-3/8	2-3/16	3/4		7/8			2-3/8		
-16	1-9/16		1-7/8	2-3/4	15/16		15/16			2-13/16		
-20					1		1					
-24							1-1/8					
-32							1-3/8					

Tubing
B

Coiled Air Hose
& Fittings
C

Transportation
D

Metric (mm)												
Hose Dash Size	51	54	56	CG	91N	92	93N	BU	CY	LV/LH	MS Reusable	MS Permanent
-2			16					13	13			
-3	21	16	16	23	11	14		21	21	21		
-4	24	19	24	30	13							
-5	24	22	25		14						17	17
-6	33	24	25	33	16		11				24	19
-8	40	24	29	40	17		11			54		
-10			29		17		19			57		
-12	46		35	56	19		22			60		
-16	40		48	70	24		24			71		
-20					25		25					
-24							29					
-32							35					



Fittings
E

Tooling,
Equipment
& Accessories
F

General
Technical
G

Hose Fitting Thread Guide

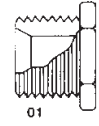
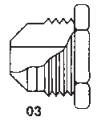
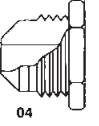
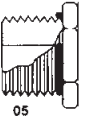
There are more than one hundred types of threads for fittings. Below are some of the most common thread styles offered by Parflex. The end code in a fitting part number is located directly after the first digit. i.e. 1**03**56-8-8

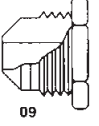
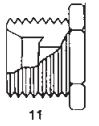
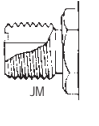
End Code								
Dash Size	NPTF Pipe Thread Size	SAE (JIC) 37° Flare Thread Size	SAE 45° Flare Thread Size	“O” Ring Style Straight Thread Size	SAE Inverted Flare Thread Size	PTT 30° Flare Thread Size	SAE Flareless Thread Size	Seal-Lok™ Thread
2	1/8 - 27	5/16 - 24	5/16 - 24	5/16 - 24	-	-	5/16 - 24	-
3	-	3/8 - 24	3/8 - 24	3/8 - 24	3/8 - 24	-	3/8 - 24	-
4	1/4 - 18	7/16 - 20	7/16 - 20	7/16 - 20	7/16 - 18	-	7/16 - 20	9/16 - 18
5	-	1/2 - 20	1/2 - 20	1/2 - 20	1/2 - 20	-	1/2 - 20	-
6	3/8 - 18	9/16 - 18	5/8 - 18	9/16 - 18	5/8 - 18	-	9/16 - 18	11/16 - 16
8	1/2 - 14	3/4 - 16	3/4 - 16	3/4 - 16	3/4 - 18	-	3/4 - 16	13/16 - 16
10	-	7/8 - 14	7/8 - 14	7/8 - 14	7/8 - 18	-	7/8 - 14	1 - 14
12	3/4 - 14	1 1/16 - 12	1 1/16 - 14	1 1/16 - 12	1 1/16 - 16	-	1 1/16 - 12	1 3/16 - 12
14	-	1 3/16 - 12	-	1 3/16 - 12	-	-	1 3/16 - 12	-
16	1 - 11 1/2	1 5/16 - 12	-	1 5/16 - 12	-	1 5/16 - 14	1 5/16 - 12	1 7/16 - 12
20	1 1/4 - 11 1/2	1 5/8 - 12	-	1 5/8 - 12	-	1 5/8 - 14	1 5/8 - 12	-
24	1 1/2 - 11 1/2	1 7/8 - 12	-	1 7/8 - 12	-	1 7/8 - 14	1 7/8 - 12	-
32	2 - 11 1/2	2 1/2 - 12	-	2 1/2 - 12	-	2 1/2 - 12	2 1/2 - 12	-

Hose Fitting Thread Guide (cont.)

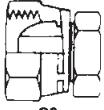
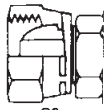
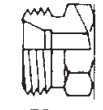
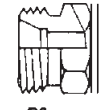
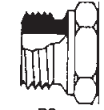
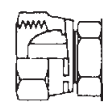
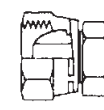
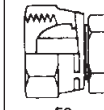
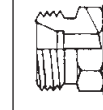
End Code ↓									
Dash Size	Metric Swivel Female Thread Size	Metric Swivel Female Thread Size	Male Stud Thread Size	Male Stud Thread Size	Male BSPP Thread Size	BSP Swivel Female Thread Size	French Swivel Female Gas Series	French Swivel Female Metric Series	French Male Stud Gas Series
4	-	-	-	-	1/4"	1/4"	-	-	-
6	M12 x 1,5	-	M12 x 1,5	-	3/8"	3/8"	-	M12 x 1	-
8	M14 x 1,5	M16 x 1,5	M14 x 1,5	M16 x 1,5	1/2"	1/2"	-	M14 x 1,5	-
10	M16 x 1,5	M18 x 1,5	M16 x 1,5	M18 x 1,5	-	5/8"	-	M16 x 1,5	-
12	M18 x 1,5	M20 x 1,5	M18 x 1,5	M20 x 1,5	3/4"	3/4"	-	M18 x 1,5	-
-	-	-	-	-	-	-	M20 x 1,5	-	M20 x 1,5
14	-	M22 x 1,5	-	M22 x 1,5	-	-	-	M20 x 1,5	-
15	M22 x 1,5	-	M22 x 1,5	-	-	-	-	M22 x 1,5	-
16	-	M24 x 1,5	-	M24 x 1,5	1"	1"	-	M24 x 1,5	-
-	-	-	-	-	-	-	M24 x 1,5	-	M24 x 1,5
18	M26 x 1,5	-	M26 x 1,5	-	-	-	-	M27 x 1,5	-
20	-	M30 x 2	-	M30 x 2	-	-	-	M27 x 1,5	-
-	-	-	-	-	-	-	M30 x 1,5	-	M30 x 1,5
22	M30 x 2	-	M30 x 2	-	-	-	-	M30 x 1,5	-
25	-	M36 x 2	-	M36 x 2	-	-	-	M33 x 1,5	-
-	-	-	-	-	-	-	M36 x 1,5	-	M36 x 1,5
28	M36 x 2	-	M36 x 2	-	-	-	-	-	-
30	-	M42 x 2	-	M42 x 2	-	-	-	M39 x 1,5	-
33	-	-	-	-	-	-	M45 x 1,5	-	M45 x 1,5

Hose
A

Tubing
B

Coiled Air Hose
& Fittings
C

Transportation
D

Fittings
E

Tooling,
Equipment
& Accessories
F

General
Technical
G

Media to Fitting & Seal Compatibility

Media	Fitting Material			Seal Material			
	Brass	Steel	316 SS	BUNA-N	Ethylene Propylene	Fluorocarbon	Neoprene
Acetylene	NR	F	S	S	S	S	F
Air (oil free) @ 190° F	S	F	S	S	S	S	S
Air (oil free) @ 300° F	S	F	S	F	F	S	F
Air (oil free) @ 400° F	S	F	S	NR	NR	S	NR
Alcohol, Ethyl	S	NR	NR	NR	S	NR	S
Animal Oils (Lard Oil)	F	F	F	S	F	S	F
Aromatic Fuel - 50%	ID	ID	ID	F	NR	S	NR
Aromatic Solvents	ID	ID	F	F	ID	S	NR
Asphalt	NR	NR	S	F	NR	S	F
ASTM Oil #1	S	S	S	S	NR	S	S
ASTM Oil #2	S	S	S	S	NR	S	F
ASTM Oil #3	S	S	S	S	NR	S	NR
ASTM Oil #4	S	S	S	F	NR	S	NR
ATF Oil	S	S	S	S	NR	S	F
Automotive Brake Fluid	ID	ID	ID	NR	S	NR	F
Benzene	NR	F	NR	NR	NR	S	NR
Brine (Sodium Chloride)	NR	NR	S	S	S	S	S
Butane	NR	S	S	S	NR	S	S
Carbon Dioxide	S	F	S	S	S	S	S
Carbon Monoxide	S	S	S	S	S	S	F
Chlorine (Dry)	F	F	NR	NR	ID	F	F
Compressed Air	S	F	S	S	S	S	S
Crude Oil	NR	F	S	F	NR	S	NR
Cutting Oil	ID	S	S	S	NR	S	F
Diesel Fuel	S	S	S	S	NR	S	NR
Ethanol	S	NR	NR	NR	S	NR	S
Ethers	S	S	S	NR	F	F	NR
Freon 11	S	ID	ID	F	NR	F	NR
Freon 12	S	S	NR	F	NR	S	S
Freon 22	S	NR	S	NR	NR	NR	S
Fuel Oil	NR	S	S	S	NR	S	F
Gasoline	S	F	S	S	NR	S	NR
Gas, Liquid Propane (LPG)	S	S	S	S	NR	S	F
Gas, Natural	F	S	S	S	NR	S	S
Helium	S	S	S	S	S	S	S
Hydraulic Oil, Petroleum Base	S	S	S	S	NR	S	S
Hydraulic Oil, Water Base	ID	S	S	F	S	NR	F
Hydrogen Gas	S	S	S	S	S	S	S
Jet Fuel	S	S	S	S	NR	S	NR
Kerosene	S	S	S	S	NR	S	F

(Cont.)

Media to Fitting & Seal Compatibility (cont.)

Hose
A

Media	Fitting Material			Seal Material			
	Brass	Steel	316 SS	BUNA-N	Ethylene Propylene	Fluorocarbon	Neoprene
Lubricating Oil SAE 10, 20, 30, 40, 50	S	S	S	S	NR	S	F
Methanol	S	S	S	S	S	NR	S
MIL-F-8192 (JP-9)	S	S	S	NR	NR	S	NR
MIL-H-5606	S	S	S	S	NR	S	F
MIL-H-6083	S	S	S	S	NR	S	S
MIL-H-7083	S	S	S	S	S	F	F
MIL-H-8446 (MLO-8515)	F	S	S	F	NR	S	S
Mil-L-2104 & 2104B	S	S	S	S	NR	S	F
MIL-L-7808	NR	F	S	F	NR	S	NR
Mineral Oil	S	S	S	S	NR	S	F
Nitrogen	S	S	S	S	S	S	S
Petrolatum	S	S	S	S	NR	S	F
Petroleum Oil (<250° F)	S	S	S	S	NR	S	F
Propane	S	S	S	S	NR	S	F
R134A	S	S	S	NR	S	NR	NR
Sea Water	F	NR	S	S	S	S	F
Skydrol 500, Type 2	NR	S	S	NR	S	NR	NR
Skydrol 7000, Type 2	NR	S	S	NR	S	F	NR
Soap Solutions	NR	NR	S	S	S	S	F
Steam (<400° F)	F	S	S	NR	S	NR	NR
Stoddard Solvent	F	S	S	S	NR	S	F
Transmission Fluid (Type A)	S	S	S	S	NR	S	F
Trichloroethane	ID	F	S	NR	NR	S	NR
Water	S	F	S	S	S	F	F

Tubing
B

Coiled Air Hose & Fittings
C

Transportation
D

Fittings
E

Tooling, Equipment & Accessories
F

Table U4 – Fluid Compatibility Chart

Codes:
S = Satisfactory
F = Fair
NR = Not recommended
ID = Insufficient data

General Technical
G

Metal Tube & Fitting Material Compatibility

As a general rule, tube and fitting materials should be the same. If different materials must be considered, the following chart can be used as a general guide. Since operating conditions differ with applications, this chart should be used only as a guide and not a firm recommendation. Before making a final

decision on material combination, it should be sufficiently tested under appropriate conditions to assure suitability for the intended application. For additional material combinations, contact the Tube Fittings Division.

Tube Material	Specification	Construction	Condition	Maximum Hardness	Temperature Range (7)	Application	Tube Material to Fitting & Material Compatibility												
							Seal-Lok™ ORFS (SAE J1453)			Triple-Lok® 37° Flare (SAE J514)			Ferulok® Flareless (SAE J514)			Intru-Lok® Flareless EO/EO-2 Flareless (ISO 8434-1)			
							S	SS	B	S	SS	B	M	S	SS	M	B	S	SS
Carbon Steel C-1010	SAE J524 [ASTM A179] (8)	Seamless	Fully Annealed	HRB 72	-65° to 500°F -55° to 260°C	High pressure hydraulics, air, & some specialty chemicals	E	NR	(6)	G	NR	(6)	NR	E	NR	NR	NR	NR	
	SAE J525 [ASTM A178] (8)	Welded & Drawn					E	NR	(6)	E	NR	(6)	NR	E	NR	NR	NR	NR	
	SAE J356	Welded & Flash Controlled					G	NR	(6)	NR	NR	(6)	NR	G	NR	NR	NR	NR	
Carbon Steel C-1021	SAE J2467	Welded & Flash Controlled	Fully Annealed	HRB 75	-65° to 500°F -55° to 260°C	High pressure hydraulics	E	NR	(6)	NR	NR	(6)	NR	E	NR	NR	NR	NR	
	SAE J2435	Welded & Drawn					E	NR	(6)	E	NR	(6)	NR	E	NR	NR	NR	NR	
Carbon Steel High Strength Low Alloy (HSLA)	SAE 2613	Welded & Flash Controlled	Sub-critically annealed	HRB 90	-65° to 500°F -55° to 260°C	High pressure hydraulics	E	NR	(6)	NR	NR	NR	NR	NR	NR	NR	NR	NR	
	SAE J2614	Welded & Drawn					E	NR	(6)	NR	NR	NR	NR	NR	NR	NR	NR	NR	
Alloy Steel 4130	ASTM A519	Seamless			-65° to 500°F -55° to 260°C	High pressure hydraulics	E	NR	NR	NR	NR	NR	NR	NR	NR	NR	NR	NR	
St 37.4 (Carbon Steel)	DIN 2391 Part 2 (Metric)	Seamless	Fully Annealed	HRB 72	-65° to 500°F -55° to 260°C	High pressure hydraulics, air, & some specialty chemicals	E	NR	NR	G	NR	NR	NR	NR	NR	NR	NR	E	
Stainless Steel 304 & 316	ASTM A213 ASTM A269	Seamless	Fully Annealed	HRB 90	-425° to 1200°F -255° to 650°C (3)	High pressure, high temp, or generally corrosive media (1)	(6)	E	(6)	(6)	G	(6)	NR	(6)	E	NR	NR	NR	
	ASTM A249 ASTM A269	Welded & Drawn					(6)	E	(6)	(6)	E	(6)	NR	(6)	E	NR	NR	NR	
1.4571 1.4541 Stainless Steel	DIN 17458 Tab 8 (Metric)	Seamless	Fully Annealed	HRB 90	-425° to 120°F -255° to 650°C (3)	High pressure, high temp, or generally corrosive media (1)	(6)	E	NR	(6)	G	NR	NR	NR	E	NR	NR	E	
Copper	SAE J528 [ASTM B-75] (8)	Seamless	Soft Annealed Temper 0	60 Max. Rockwell 15T	-325° to 400°F -200° to 205°C	Low pressure, low temp, water, oil & air	E	(6)	E	G	(6)	E	NR	G	(2)	NR	NR	E	E
Aluminum 6061	ASTM-B210	Seamless	T6 Temper	HRB 56	-325° to 400°F -200° to 205°C	Low pressure, low temp, water, oil, air & some specialty chemicals	NR	NR	NR	G	NR	NR	NR	E	(2)	NR	NR	(6)	NR
			0 & T4 Temper	HRB 30			E	(5)	NR	NR	G	NR	NR	NR	E	(2)	NR	NR	(6)
Monel 400	ASTM-B165	Seamless	Fully Annealed	HRB 70	-400° to 800°F -240° to 425°C	Sour gas, marine & gen chemical processing media	NR	(6)	NR	NR	(6)	NR	E	NR	(6)	E	NR	NR	

(Cont.)

Metal Tube & Fitting Material Compatibility (cont.)

Hose
A

Tubing
B

Coiled Air Hose
& Fittings
C

Transportation
D

Fittings
E

Tooling,
Equipment
& Accessories
F

General
Technical
G

Tube Material	Specification	Construction	Condition	Maximum Hardness	Temperature Range (7)	Application	Tube Material to Fitting & Material Compatibility											
							Seal-Lok™ ORFS (SAE J1453)			Triple-Lok® 37° Flare (SAE J514)			Ferulok® Flareless (SAE J514)			Intru-Lok® Flareless E0/E0-2 Flareless (ISO 8434-1)		
							S	SS	B	S	SS	B	M	S	SS	M	B	S SS B, M
Nylon		Extruded	Flexible & Semi-Rigid		-60° to 200°F -50° to 95°C	Lube lines, chemical process controls & air	NR	NR	NR	NR	NR	NR	NR	G (2)	G (2)	G (2)	E	G (2), (9)
Polyethylene	ASTM D-1248	Extruded	Instrument Grade		-80° to 150°F -60° to 65°C	Instrumentation lines	NR	NR	NR	NR	NR	NR	NR	G (2)	G (2)	G (2)	E	G (2), (9)
PVC		Extruded	Instrument & Laboratory Grade		0° to 140°F -20° to 60°C	General purpose laboratory use	NR	NR	NR	NR	NR	NR	NR	NR	NR	NR	G	NR
PTFE		Extruded & Sintered			-65° to 400°F -55° to 205°C	Very high temp, fuel, lube, chemical, pharma, food	NR	NR	NR	NR	NR	NR	NR	G (2)	G (2)	G (2)	G	G (2), (9)

Table U7 – Tube and Fitting Material Compatibility

Ratings Key:

NR = Not Recommended
F = Fair
G = Good
E = Excellent

Fittings Materials Code:

S = Steel
SS = Stainless Steel
B = Brass
M = Monel

Notes:

1. For highly corrosive media or service environment, contact the Tube Fittings Division.
2. Requires different assembly procedure. Contact the Tube Fittings Division.
3. Low temperature limit for stainless steel Ferulok® fittings is -20°F (-30°C).
4. For brazing only. Grade 4130 not recommended with Parflange process.
5. For use with Parflange process only. Not recommended with brazing.
6. Use depends on specific application. Contact the Tube Fittings Division.
7. Applies to tube material.
8. Comparable specifications to SAE.
9. With metric version of tubing.
10. Not tested with Parflange. Contact the Tube Fittings Division.

O-Ring Material Selection

Standard O-rings supplied with Parker tube fittings and adapters are 90 durometer hard nitrile (Buna-N) Parker compound #N0552. These O-rings are well suited for most industrial hydraulic and pneumatic systems. They have high extrusion resistance making them suitable for very high pressure static applications. Optional high temperature fluorocarbon, Parker compound #V0894, is also available for higher temperature specifications.

O-rings for other than normal hydraulic media or higher temperature applications can be selected from the following chart. The chart should be used only as a general guide. Before making final selection for a given application, it is recommended that appropriate tests be conducted to assure compatibility with the fluid, temperature, pressure and other environmental conditions.

For fluids not shown in the chart, please contact the Tube Fittings Division.

Polymer	Abbreviated Name	Parker Compound No.	Color	SAE J515 Type	Hardness Shore "A" ⁷	Temperature Range	Recommended For	Not Recommended For
Nitrile-Butadiene	NBR	N0552	● B	CH ²	90 ⁶	-30° to 250°F	Petroleum base oils and fluids, mineral oils, ethylene glycol base fluids, silicone and di-ester base lubricants, air, water under 150°F, and natural gas. Hydrogen fuel cells. Meets FDA requirements for food products. CNG Applications.	Phosphate ester base hydraulic fluids, automotive brake fluids, strong acids, ozone, freons, ketones, halogenated hydrocarbons, and methanol.
		N0674		-	70	-30° to 250°F		
		N0103		-	70	-65° to 225°F		
		N1059		CH ²	90	-30° to 275°F		
		N0507		-	90	-65° to 180°F		
		N0304		-	75	-65° to 225°F		
		N0508		-	75	-35° to 250°F		
N0756	-	75 ⁶	-65° to 275°F					
Ethylene-Propylene	EPDM	E0540	● B	CA ³	80	-65° to 275° F	Phosphate ester base hydraulic fluids, hot water, steam to 400°F, silicone oils and greases, dilute acids and alkalis, ketones, alcohols and automotive brake fluids. CO ₂ climate control systems.	Petroleum base oils and di-ester base lubricants.
		E0893	● P ¹	CA ³	80			
		E0962	● B	-	90			
Neoprene	CR	C0873	● B	-	70	-45° to 250° F	Refrigerants (freons, ammonia), high aniline point petroleum oils, mild acids and silicate ester lubricants.	Phosphate ester fluids and ketones.
		C0944	● R ¹	-	70			
Fluorocarbon	FKM ⁵ or FPM	V0747	● B	-	75	-15° to 400° F	Petroleum base oils and fluids, some phosphate ester base fluids, silicone and silicate ester base lubricants, di-ester base lubricants, acids and halogenated hydrocarbons.	Ketones, skydrol fluids, amines (VDMH), anhydrous ammonia, low molecular weight esters and ethers, and hot hydrofluoric or chloro-sulfonic acids.
		V0884	● BR ¹	-	75			
		V0894	● BR ¹	HK ⁴	90 ⁶			
Silicone	Si	S0604	● RU ¹	-	70	-65° to 450° F	Dry heat (air to 400°F) and high aniline point oils.	Most petroleum fluids, ketones, water and steam.

Table U-6 – O-Ring Selection

*Color Code: B – Black, P – Purple, R – Red, BR – Brown, RU – Rust

Notes:

1. These Parker "Chromasure" color assurance O-rings are available from the Parker Hannifin O-Ring Division. They help eliminate assembly errors, reduce warranty costs and liability risks, and assure safety in aftermarket business.
2. Formerly SAE Type I.
3. Formerly SAE Type II.
4. Formerly SAE Type III.
5. "FKM" is the ASTM designation for fluorocarbon. Its ISO designation is "FPM".
6. Standard compounds available from stock.
7. Use 90 durometer hard O-rings for applications with 1500 psi or higher pressures.

Metals Corrosion Scale

Corrosion of Base Metals in Contact

The susceptibility of different base metals to corrosion while in contact depends upon the difference between the contact potentials or the electromotive voltages of the metals involved. The greater the potential difference is, the greater is the tendency for corrosion. The metal with the higher potential forms the anode and is corroded. The larger the separation distance in the electromotive chart between the two metals in contact, the higher the contact potential and chances for corrosion. For example, zinc and aluminum are very short distance apart in the chart; therefore potential for corrosion when these two metals are in contact is very low. On the other hand, aluminum and passivated 316 stainless steel are far apart; hence, when in

contact, the potential for corrosion is very high. Aluminum, being more anodic metal, will corrode in this combination. As a general guideline, if the metals are half the length of the chart or more apart, the combination should be avoided. Also, it is not a good idea to combine an anodic metal part with thin cross section, such as thin wall tubing, with a cathodic or less anodic metal part of a heavy cross section, such as a fitting.

Example: A thin wall brass tube with steel fitting is a better, although not ideal, combination than a thin wall steel tube with brass fitting.

Electromotive or Galvanic Series for Metals	
+ Anodic (least noble) corroded	Magnesium Magnesium alloys Zinc (Parker steel fittings are zinc plated) Berillium Aluminum 5052, 3004, 3003, 1100, 6053 Cadmium Aluminum 2117, 2017, 2024 Mild steel (1018), wrought iron, free machining steel (12L14) Low alloy high strength steel, cast iron Chrome iron (active) 430 Stainless (active) 302, 303, 321, 347, 410, 416, stainless steel (active) Ni-resist 316, 317 stainless steel (active) Carpenter 20Cb-3 stainless (active) Aluminum bronze (CA 687) Hastelloy C (active) Inconel 625 (active) Titanium (active) Lead/Tin solder Lead Tin Inconel 600 (active) Nickel (active) 60 Ni-15 Cr (active) 80 Ni-20 Cr (active) Hastelloy B (active) Naval brass (CA 464), Yellow brass (CA 268), Brass (CA360) Red brass (CA 230), Admiralty brass (CA 443) Copper (CA 102) Maganese bronze (CA 675), Tin bronze (CA 903, 905) 410, 416 Stainless (passive) Phosphor bronze (CA 521, 524) Silicon bronze (CA 651, 655) Nickel silver (CA 732, 735, 745, 752, 754, 757, 764, 770, 794) Cupro Ni 90-10 Cupro Ni 80-20 430 Stainless steel (passive) Cupro Ni 70-30 Nickel aluminum bronze (CA 630, 632) Monel 400, K500 Silver solder Nickel (passive) 60 Ni 15 Cr (passive) Inconel 600 (passive) 80 Ni 20 Cr (passive) Chrome iron (passive) 302, 303, 304, 321, 347 stainless steel (passive) 316, 317 stainless steel (passive) (Parker stainless steel fittings are passivated) Carpenter 20 Cb-3 stainless (passive), Incoloy 825 Silver Titanium (passive), Hastelloy C & C276 (passive), Inconel 625 (passive) Graphitic Zirconium Gold Platinum
- Cathodic (most noble) protected	

Table U5 – Electromotive or Galvanic Series for Metals

Materials to Parflex Part Number Guide

Ratings Code:

- G – Good to excellent. Little or no swelling, tensile or surface changes. Preferred choice.
- L – Marginal or conditional. Noticeable effects but not necessarily indicating lack of serviceability. Further testing suggested for specific application. Very long-term effects such as stiffening or potential for crazing should be evaluated.
- P – Poor or unsatisfactory. Not recommended without extensive and realistic testing.
- – Indicates that this was not tested.
- # – For fluoropolymer. Indicates good chemical resistance but potential for excessive permeation.

Material Code for Hose Core Tubes	
H	Copolyester
N	Nylon
NC	Proprietary Nylon Blend
O	Polyethylene
TFE	Fluoropolymer PTFE
U	Polyurethane
Material Code for Hose Covers	
HF	Low Temperature Copolyester
M	Silicone
U	Polyurethane
UTJ	TOUGHJACKET Polyurethane
N	Flexible Nylon
TPV	Thermoplastic Vulcanizate
Material Code for Thermoplastic Tubing	
HDPE	High Density Polyethylene
N	Flexible Nylon
NR	Unplasticized Nylon (semi-rigid)
PE	Linear Low Density Polyethylene
PEFR	Flame Resistant Polyethylene
PP	Polypropylene
PV	Flexible Polyvinyl Chloride (PVC)
U	Polyurethane

Hose
D6R, H6, R6, HFSR, HFS2R, HTB, 560TJ, 563TJ, 590TJ, 594TJ, 510C, 518C, 515H, 53DM/538DM, 55LT, HLB, S6, S9
518D, 520N, 527BA, 528N, 540N, 56DH, 575X, 575XN, 580N, H580N, 588N, 1035HT, 5CNG, MSH, MSXL, PTH, S5N, 1035HT, CNGRP
510A
540P
919/919B, 919J, 919U, 929/929B, 929BJ, 939/939B, 944B, 955B, STW/STB, SCW/SCB, NCW/NCB, SCW/SCBV, SCWV-FS/SCBV-FS
83FR, B9
Hose
55LT, 53DM/538DM
919J, 929BJ
560TJ, 563TJ, 590TJ, 594TJ, 510A, 510C, 515H, 518C, 518D, 520N, 528N, 527BA, 540N, 540P, 56DH, 575X, 580N, 588N, 83FR, 1035HT, B9, 5CNG, HLB, MSH, PTH, S5N, S6, S9
560TJ, 563TJ, 590TJ, 594TJ
575XN
CNGRP
Tubing
HDPE
N
NR
E
PEFR
PP
PV
U, HU

Material Code for Fluoropolymer Tubing	
FEP	Fluorinated Ethylene Propylene
PFA	Perfluoroalkoxy
TFE	Polytetrafluoroethylene

Tubing
103, 203, HS1.3FEP, HS1.6FEP, CV03, CR03, 81914/3, 81914/4
104, 204, 105, 205, CV04, CR04, 704, 705
TFL, TFS, TFT, TFH, 101, 201, HS2TFS, HS2TFT, HS2TFL, HS2TFI, HS4TFI, CV01, CVL, CVH, 81914/1, 81914/2

Media to Hose Material Compatibility Guide

Hose
A

Media	H	N	U/HF UFR	PV	NC	O	HFR	FEP	PTFE/ PFA
Acetaldehyde	G	L	L	P	-	L	G	G	G
Acetic Acid Glacial	L	L	L	G	P	G	L	L	G
Acetone	L	G	P	P	G	P	L	G	G
Acetylene	2	2	2	2	2	2	2	2	2
Air (4)	G	G	G	G	G	G	G	G	G
Ammonium Chloride	G	P	G	G	P	G	G	L	G
Ammonium Hydroxide	L	G	P	L	-	G	L	G	G
Anhydrous Ammonia	P	P	P	P	P	P	P	8	8
Aniline	P	P	P	P	P	L	P	G	G
Animal Oils (6)	G	G	G	G	G	P	G	-	G
Aromatic Hydrocarbons	L	G	L	P	G	P	L	-	G
Asphalt	G	G	G	G	G	L	G	L	G
Baygon (Insecticide)	L	G	P	-	-	-	L	-	G
Beer	G	G	G	G	-	G	G	G	G
Benzene	L	G	L	P	L	P	L	G	G
Brake Fluid (DOT #3)	-	G	P	P	-	P	-	-	G
Butane (2) (4)	G	G	L	L	P	L	G	#	#
Butter (6)	G	G	G	G	-	G	G	-	G
Calcium Chloride	G	3	G	L	3	G	G	G	G
Carbon Dioxide (4)	G	G	G	G	G	G	G	#	#
Carbon Monoxide (4)	G	3	G	G	3	L	G	#	#
Carbon Tetrachloride	L	G	P	L	G	P	L	G	G
Castor Oil	G	L	L	G	L	P	G	-	G
Chlorinated Hydrocarbon Base Fluids	L	G	L	P	-	-	L	-	G
Chlorinated Petroleum Oil	G	G	L	-	L	-	G	-	-
Chlorinated Solvents	P	3	P	L	3	L	P	-	G
Chlorine, Gaseous, Dry	P	P	P	G	P	L	P	#	#
Chlordane (Insecticide)	L	G	P	-	-	-	L	-	-
Chloroform	P	P	P	P	P	P	P	G	G
Chromic Acid	P	3	P	G	P	3	P	L	G
Citric Acid Solutions	G	G	L	G	G	G	G	G	G
Crude Petroleum Oil	G	G	G	G	G	P	G	-	G
Cyclohexane (2)	G	G	G	-	-	P	G	G	G
Cygon (Insecticide)	L	G	P	-	-	-	L	-	-
Diazion (Insecticide)	L	-	P	L	-	-			
Diesel Fuel (2)	G	G	G	L	G	P	G	-	G
Diester Oils	L	G	P	P	-	P	L	-	G
Enamels	G	G	G	L	-	L	G	-	G
Ethanol (6)	G	G	L	L	L	G	G	-	G
Ethers	L	G	P	L	G	L	L	G	G
Ethylene Glycol	L	G	L	G	G	G	G	G	G
Ethylene Oxide	G	G	L	P	-	L	G	#	#
Fatty Acids	G	G	3	G	G	L	G	G	G
Formaldehyde	L	L	P	L	L	G	L	G	G
Formic Acid	P	P	P	G	P	G	P	G	G

Tubing
B

Coiled Air Hose
& Fittings
C

Transportation
D

Fittings
E

Tooling,
Equipment
& Accessories
F

General
Technical
G

[Cont.]

Media to Hose Material Compatibility Guide (cont.)

Media	H	N	U/HF UFR	PV	NC	O	HFR	FEP	PTFE/ PFA
Freon 12 (5)	P	G	L	G	G	L	P	#	#
Freon 22 (5)	P	G	L	G	G	L	P	#	#
Fruit Juices	G	G	G	G	-	G	G	-	G
Fuel Oil (2)	G	G	L	L	G	P	G	G	G
Gas (Oil) (2)	G	G	G	G	G	P	G	-	G
Gas (Natural) (4)	2	2	2	2	2	2	2	2	2
Gasoline (2)	G	G	3	P	G	P	G	G	G
Glue	3	3	3	3	3	3	3	3	3
Glycerin	G	G	L	G	G	G	G	G	G
Glycols (to 135°F)	L	G	L	G	G	-	G	G	G
Grease (Petroleum base)	G	G	G	G	G	L	G	-	G
Heptachlor (Insecticide)	L	G	P	L	-	P	L	-	G
Hexane (2)	G	G	G	L	G	P	G	G	G
Houghto Safe-600 Series (Hydraulic fluid)	G	G	L	G	G	G	G	-	G
Houghto Safe-1000 Series (Phosphate esters)	L	G	P	G	G	P	L	-	G
Hydraulic Fluid (Petroleum base)	G	G	G	G	G	L	G	L	G
Hydraulic Fluid (Phosphate ester base)	L	G	L	L	G	P	L	-	G
Hydraulic Fluid (Water glycol base)	G	G	G	L	G	-	G	-	G
Hydraulic Oil (Petroleum base)	G	G	G	G	G	L	G	L	G
Hydrochloric Acid	P	L	P	L	P	L	P	G	G
Hydrofluoric Acid	P	P	P	L	P	L	P	G	G
Hydrogen, Gaseous (2) (4) (5)	G	G	G	G	G	G	#	#	
Hydrolube (Hydraulic fluid/water glycol base)	G	G	L	G	G	G	G	-	G
IRUS 902 (Hydraulic fluid/water-oil emulsion)	G	G	G	G	G	L	G	-	G
Isocyanates (2)	L	L	L	P	-	L	L	-	G
IsoOctane (2)	G	G	G	L	G	L	G	G	G
Isopropyl Alcohol	G	G	L	L	G	G	G	G	G
Kerosene (2)	G	G	L	L	G	L	G	G	G
Ketones	L	G	P	P	G	G	L	G	G
Lacquer Solvents	L	G	P	P	3	L	L	L	G
Lactic Acid	P	G	P	G	G	G	P	G	G
Lime (Calcium oxide)	G	G	G	G	-	G	G	G	G
Lindol (Hydraulic fluid/phosphate esters)	L	G	P	-	-	-	L	-	G
Linseed Oil	G	G	G	L	G	L	G	G	G
LP - Gas	2	2	2	2	2	2	2	2	2
Lubricating Oils (Diester base)	L	G	P	-	G	-	L	-	G
Lubricating Oils (Petroleum base)	G	G	G	G	G	L	G	G	G
Malathion (Insecticide)	L	G	P	-	-	-	L	-	G
Magnesium Hydroxide	L	G	L	G	-	G	L	G	G
Magnesium Salts	-	G	G	G	-	G	-	-	G
Mercury	G	G	G	G	G	G	G	G	G
Meropa Oil (Sulphur base)	G	G	-	-	-	-	-	-	G
Methane	2	2	2	2	2	2	2	2	2
Methanol	G	G	P	P	G	L	G	-	G
Methoxychlor (Insecticide)	L	G	P	-	-	-	L	-	G

(Cont.)

Media to Hose Material Compatibility Guide (cont.)

Media	H	N	U/HF UFR	PV	NC	O	HFR	FEP	PTFE/ PFA
Methyl Alcohol (6)	G	G	P	P	G	L	G	G	G
Methylene Chloride	P	L	P	L	P	L	P	G	G
Methyl Ethyl Ketone (MEK)	L	G	P	P	G	G	L	G	G
Methyl Ethyl Ketone Peroxide (MEKP)	-	L	P	-	-	-	-	-	G
Methyl Isobutyl Ketone (MIBK)	L	G	P	P	G	L	L	G	G
Milk (6)	G	G	G	G	-	G	G	G	G
Mineral Oil	G	G	G	G	G	L	G	G	G
Mineral Spirits	P	-	L	P	-	-	P	-	G
Motor Oils	G	G	G	G	G	-	G	G	G
Naphtha	L	G	P	P	G	P	L	G	G
Natural Gas (4)	2	2	2	2	2	2	2	2	2
Nitric Acid	P	P	P	L	P	P	P	L	G
Nitrobenzene	P	G	P	P	G	P	P	G	G
Nitrogen, Gaseous (4) (5)	G	G	G	G	G	G	G	G	G
Nitrous Oxide	-	L	-	G	-	L	-	#	#
Oil (SAE)	G	G	G	G	G	L	G	-	G
Oil of Turpentine	G	G	P	G	G	P	G	-	G
Oleic Acid	G	G	G	L	G	L	G	G	G
OS 45 Type 3 Hydraulic Fluid (Silicate esters)	L	G	L	P	-	P	L	-	-
Oxygen, Gaseous (4) (5) (6)	G	G	G	G	G	G	G	G	G
Ozone	L	P	L	G	P	L	L	G	G
Paint Solvents (Oil base)	L	G	L	P	-	P	L	-	G
Paint (Oil Base) (7)	G	G	G	P	-	L	G	-	G
Pentane (2)	G	G	L	L	-	P	G	G	G
Perchloric Acid	P	P	P	L	P	P	P	L	G
Perchloroethylene	P	P	P	L	P	P	P	-	G
Petroleum Ether	-	2	2	P	2	P	-	2	2
Petroleum Oils	G	G	G	G	G	L	G	-	G
Phenols	P	P	P	L	P	P	P	-	G
Phosphate Esters (above 135°F)	P	G	P	P	-	P	L	-	G
Phosphate Esters (to 135°F)	G	G	P	P	G	P	G	-	G
Polyol Esters	L	G	P	P	-	-	L	-	G
Potassium Hydroxide, 50%	P	P	P	L	-	L	P	G	G
Propane (4) (5)	2	2	2	2	2	2	2	2	2
Propylene Glycol	-	-	G	G	-	G	-	G	G
Pydraul F-9, 150, 160 (to 135°F)	G	G	P	P	G	P	G	-	G
Pydraul 312C, 625 (to 135°F)	P	G	P	P	G	P	G	-	G
Quintolubric 822 Fluid	-	G	G	-	-	-	-	-	G
Salt Water	3	3	3	3	3	3	3	G	G
Sevin (Insecticides in water)	G	G	G	-	-	-	G	-	G
Silicone Greases	G	G	G	G	G	-	G	-	G
Silicone Oils	G	G	G	G	G	-	G	-	G
Skydrol 500 & 7000	L	G	P	P	G	P	L	G	G
Soap Solutions	G	G	G	G	G	G	G	G	G

(Cont.)

Hose
A

Tubing
B

Coiled Air Hose
& Fittings
C

Transportation
D

Fittings
E

Tooling,
Equipment
& Accessories
F

General
Technical
G

Media to Hose Material Compatibility Guide (cont.)

Media	H	N	U/HF UFR	PV	NC	O	HFR	FEP	PTFE/PFA
Soda Water	G	G	G	G	G	3	G	-	G
Sodium Borate	G	G	G	G	G	G	G	G	G
Sodium Carbonate	3	3	3	3	3	3	3	3	3
Sodium Chloride Solutions	G	G	G	G	3	G	G	G	G
Sodium Hydroxide, 50%	L	P	P	L	P	L	L	G	G
Sodium Hypochlorite	L	P	P	L	-	3	L	G	G
Steam	P	P	P	P	P	P	P	G	G
Stoddard Solvent	P	G	P	L	G	P	P	G	G
Straight Synthetic Oils (Phosphate esters)	L	G	P	P	G	-	L	-	G
Sulfur	G	G	G	G	-	L	G	G	G
Sulfur Dioxide	P	L	L	L	-	P	P	G	G
Sulfur Hexafluoride Gas (4) (5)	G	G	G	G	-	G	G	-	G
Sulphuric Acid	P	P	P	3	P	P	P	-	G
Toluene	L	G	L	P	G	P	L	G	G
Toloul	L	G	L	P	G	P	L	-	G
Transmission Fluid	G	G	G	P	G	-	G	-	G
Trichloroethylene	P	L	P	L	G	P	P	G	G
Trisodium Phosphate Solutions	L	G	P	G	G	G	L	G	G
Turpentine	G	G	L	L	G	P	G	G	G
Ucon (Hydraulic fluid-water glycol base)	G	G	L	G	G	-	G	-	G
Varnish	G	G	G	P	G	G	G	-	G
Vinegar (6)	L	G	L	G	G	G	L	G	G
Water (to 135°F) (6)	G	G	G	G	G	G	G	G	G
Water (above 135°F) (6)	P	G	P	L	-	P	P	L	G
Water Glycols (to 135°F)	L	G	L	G	G	L	G	-	G
Water Glycols (above 135°F)	P	P	P	L	-	P	P	-	G
Water in oil Emulsions (to 135°F)	G	G	L	G	G	-	G	-	G
Water in oil Emulsions (above 135°F)	P	G	P	L	-	-	P	-	G
Whiskey, Wines (6)	G	G	L	G	G	G	G	G	G
Wood Oils	G	G	L	G	G	-	G	-	G
Xylene	L	G	P	P	G	P	L	G	G
Zinc Chloride	G	G	G	G	P	G	G	G	G

Notes:

- The Fluid Compatibility Guides are simplified rating tabulations based on immersion tests at 75°F. Higher temperatures tend to reduce ratings. Since final selection depends on pressure, fluid and ambient temperature and other factors not known to Parker Hannifin Co., no performance guarantee is expressed or implied. Ratings do not imply compliance with specialized codes such as FDA, NSF, AGA or UL and do not cover possible fluid discoloration, taste or odor effects. For conveying foodstuffs, use FDA sanctioned materials and for potable water, use NSF listed materials. For chemicals not listed, or for advice on particular applications, please consult Product Engineering, Parflex Div., Ravenna, Ohio.
- Hose applications for these fluids must take into account legal and insurance regulations. This does not imply AGA or UL compliance.
- Satisfactory at some concentrations and temperatures, unsatisfactory in others.
- For high pressure gases, the cover should be pinpricked and the pressure must not be released quickly. Chain or restrain the hose to prevent personal injury in the event of damage or failure.
- Chemical compatibility does not imply low permeation rates. Consult the Parker factory for a suggestion for your specific requirement.
- Does not imply NSF or FDA compliance.
- Chemical compatibility does not imply acceptability for use in airless paint spray applications. These applications require a special conductive hose.
- Fluoropolymers are chemically compatible with Anhydrous Ammonia. However, extreme caution must be used in dealing with Anhydrous Ammonia since it can cause severe injuries such as blindness and/or chemical burns.

Media to Plastic Tubing Material Compatibility Guide

Media	PE	HDPE	PP	N	NR	PV	U	PEFR	FEP	PFA	PTFE
Acetone	P	L	G	G	G	P	P	L	G	G	G
Acetyl Bromide	L	L	L	P	P	P	-	-	-	-	-
Acetyl Chloride	L	L	L	P	P	P	-	-	G	G	G
Air	G	G	G	G	G	G	G	G	G	G	G
Alcohols	G	G	G	G	G	L	L	G	G	G	G
Aluminum Salts	G	G	G	G	G	G	G	G	-	-	-
Ammonia	G	G	G	G	G	G	G	L	-	-	-
Amyl Acetate	G	G	G	G	G	P	L	-	G	G	G
Aniline	L	G	L	P	P	P	P	-	G	G	G
Animal Oils (6)	P	L	L	G	G	G	G	-	-	-	G
Arsenic Salts	G	G	G	G	G	G	G	G	-	-	-
Aromatic Hydrocarbons	P	L	L	G	G	P	L	P	-	-	G
Barium Salts	G	G	G	G	G	G	G	G	-	-	-
Benzaldehyde	P	L	L	L	L	P	L	P	G	G	G
Benzene	P	L	L	G	G	P	L	P	G	G	G
Benzyl Alcohol	P	G	L	L	L	G	L	P	G	G	G
Bleaching Liquors	G	L	G	L	L	L	L	-	-	-	-
Boric Acid Solutions	G	G	G	G	G	G	G	G	G	G	G
Bromine	L	L	P	P	P	P	P	-	G	L	G
Butane (2)	L	G	G	G	G	L	P	-	#	#	#
Butanol	G	G	G	G	G	G	G	G	-	-	-
Butyl Acetate	G	G	L	G	G	P	L	G	G	G	G
Calcium Hypochlorite	L	L	P	P	L	L	P	L	G	G	G
Calcium Salts	G	G	G	G	G	G	G	G	-	-	-
Carbon Dioxide	G	G	G	G	G	G	G	G	#	#	#
Carbon Disulfide	L	L	L	L	L	P	L	-	#	#	#
Carbon Tetrachloride	P	P	L	L	L	L	P	P	G	G	G
Caustic Potash	G	G	G	G	G	L	G	-	G	G	G
Caustic Soda	G	G	G	G	G	L	G	-	G	L	G
Chloroacetic Acid	L	G	L	L	L	P	P	-	G	L	G
Chlorine (Dry)	L	L	L	P	P	G	P	-	#	#	#
Chlorine (Wet)	L	L	L	P	P	G	L	-	G	G	G
Chlorobenzene	P	L	L	L	L	P	L	P	G	G	G
Chloroform	P	L	P	P	P	P	P	P	G	G	G
Chromic Acid	L	L	L	P	P	G	P	-	L	G	G
Copper Salts	G	G	G	G	G	G	G	G	-	-	-
Cresol	P	L	L	P	P	L	P	P	G	G	G
Cyclohexanone	L	L	L	L	L	P	P	-	G	G	G
Ethers	L	L	P	G	G	L	P	-	G	G	G
Ethyl Acetate	G	G	G	G	G	P	L	-	G	G	G
Ethyl Alcohol	G	G	G	L	L	L	G	G	-	-	-
Ethylamine	L	G	L	L	L	P	L	-	-	-	-
Ethyl Bromide	P	L	L	L	L	P	-	P	-	-	-
Ethyl Chloride	P	L	P	L	L	P	-	P	G	G	G
Fatty Acids	L	L	L	G	G	L	L	P	G	G	G

[Cont.]

A
Hose

B
Tubing

C
Coiled Air Hose
& Fittings

D
Transportation

E
Fittings

F
Tooling,
Equipment
& Accessories

G
General
Technical

Media to Plastic Tubing Material Compatibility Guide (cont.)

Media	PE	HDPE	PP	N	NR	PV	U	PEFR	FEP	PFA	PTFE
Ferric Salts	G	G	G	G	G	G	G	-	-	-	-
Formaldehyde	G	G	G	L	L	L	P	-	G	G	G
Formic Acid	G	G	G	P	P	G	P	G	G	G	G
Freon	L	L	L	G	G	P	L	-	#	#	#
Gasoline (2)	P	G	L	G	G	P	L	P	G	G	G
Glucose	G	G	G	G	G	G	G	G	G	G	G
Glycerin	G	G	G	G	G	G	L	G	G	G	G
Hydriodic Acid	L	G	G	P	P	G	-	-	-	-	-
Hydrochloric Acid. (Conc.)	L	G	G	L	L	L	P	-	G	L	G
Hydrochloric Acid. (Med. Conc.)	L	G	G	L	L	L	P	-	G	L	G
Hydrofluoric Acid	L	L	G	P	P	L	P	-	G	-	G
Hydrogen Peroxide (Conc.)	L	G	L	L	L	L	G	-	-	-	-
Hydrogen Peroxide (Dil.)	L	G	L	G	G	G	G	-	-	-	-
Hydrogen Sulfide	G	G	G	G	G	G	P	-	G	G	G
Iodine	L	G	G	G	G	L	L	-	G	G	G
Kerosene (2)	L	L	L	G	G	L	L	-	G	G	G
Ketones	G	G	G	G	G	P	P	-	G	G	G
Lacquer Solvents	L	L	L	G	G	P	-	-	L	G	G
Lactic Acid	G	G	G	G	G	G	G	-	G	G	G
Lead Acetate	G	G	G	G	G	G	G	-	G	G	G
Linseed Oil	L	G	G	G	G	L	G	-	G	G	G
Magnesium Salts	G	G	G	G	G	G	G	-	-	-	G
Naphtha	L	L	L	G	G	P	L	G	G	G	G
Natural Gas	L	L	L	G	G	G	G	-	2	2	2
Nickel Salts	G	G	G	G	G	G	G	-	-	-	-
Nitric Acid (Conc.)	P	L	P	P	P	L	P	G	L	L	G
Nitric Acid (Dil.)	P	G	L	L	L	G	P	P	L	L	G
Nitrobenzene	P	L	G	L	L	P	P	P	G	G	G
Nitrogen Oxides	L	L	G	L	L	G	-	-	-	-	-
Nitrous Acid	L	L	G	L	L	G	L	-	G	G	G
Oils (Animal and Mineral)	L	L	L	G	G	L	G	-	G	G	G
Oils (Vegetable)	L	L	L	G	G	L	G	-	G	G	G
Oxygen (5) (6)	G	G	G	G	G	G	G	G	G	G	G
Perchloric Acid	P	G	L	P	P	L	P	P	L	G	G
Phenols	P	G	G	P	P	L	P	P	-	-	G
Potassium Salts	G	G	G	G	G	G	G	G	-	-	-
Pyridine	L	L	L	L	L	P	P	-	G	G	G
Silver Nitrate	G	G	G	G	G	G	G	G	G	G	G
Soap Solutions	G	G	G	G	G	G	G	G	G	G	G
Sodium Salts	G	G	G	G	G	G	G	G	-	-	-
Stearic Acid	L	L	L	G	G	P	L	-	G	G	G
Sulfur Chloride	L	L	P	L	L	L	-	-	G	G	G
Sulfuric Acid (Conc.)	P	G	G	P	P	L	P	P	-	-	-
Sulfuric Acid (Dil.)	P	G	G	L	L	G	L	P	-	-	-
Sulfurous Acid	P	G	L	L	L	G	L	P	G	G	G

(Cont.)

Media to Plastic Tubing Material Compatibility Guide (cont.)

Media	PE	HDPE	PP	N	NR	PV	U	PEFR	FEP	PFA	PTFE
Tannic Acid	G	G	G	G	G	G	P	-	G	G	G
Tanning Extracts	G	G	G	G	G	G	P	-	-	-	-
Titanium Salts	G	G	G	G	G	G	G	G	-	-	-
Toluene	P	L	P	G	G	P	L	P	G	G	G
Trichloroacetic Acid	L	L	L	P	P	P	P	-	-	-	-
Trichloroethylene	P	L	P	L	L	P	P	P	G	G	G
Turpentine	P	P	L	G	G	L	L	-	G	G	G
Urea	G	G	G	G	G	G	G	-	G	L	G
Uric Acid	G	G	G	G	G	G	G	-	G	G	G
Water (6)	G	G	G	G	G	G	G	G	G	G	G
Xylene	P	L	P	G	G	P	P	P	G	G	G
Zinc Chloride	G	G	G	G	G	G	G	-	G	L	G

Notes:

- The Fluid Compatibility Guides are simplified rating tabulations based on immersion tests at 75°F. Higher temperatures tend to reduce ratings. Since final selection depends on pressure, fluid and ambient temperature and other factors not known to Parker Hannifin Co., no performance guarantee is expressed or implied. Ratings do not imply compliance with specialized codes such as FDA, NSF, AGA or UL and do not cover possible fluid discoloration, taste or odor effects. For conveying foodstuffs use FDA sanctioned materials, and for potable water use NSF listed materials. For chemicals not listed, or for advice on particular applications, please consult Product Engineering, Parflex Div., Ravenna, Ohio.
- Hose applications for these fluids must take into account legal and insurance regulations. This does not imply AGA or UL compliance.
- Satisfactory at some concentrations and temperatures, unsatisfactory in others.
- For high pressure gases, the cover should be pinpricked and the pressure must not be released quickly. Chain or restrain the hose to prevent personal injury in the event of damage or failure.
- Chemical compatibility does not imply low permeation rates. Consult the Parker factory for a suggestion for your specific requirement.
- Does not imply NSF or FDA compliance.
- Chemical compatibility does not imply acceptability for use in airless paint spray applications. These applications require a special conductive hose.
- Fluoropolymers are chemically compatible with Anhydrous Ammonia. However, extreme caution must be used in dealing with Anhydrous Ammonia since it can cause severe injuries such as blindness and/or chemical burns.

Metric Conversion Chart

A Hose

B Tubing

C Coiled Air Hose & Fittings

D Transportation

E Fittings

F Tooling, Equipment & Accessories

G General Technical

English to Metric			
	To Convert From	To	Multiply By
Area	Sq. in. (in ²)	Sq. mm (mm ²)	645.16
	Sq. in. (in ²)	Sq. cm (cm ²)	6.4516
	Sq. ft. (ft ²)	Sq. meters (m ²)	0.0929
Density	Pounds/Cubic foot (lb./ft ³)	Kilograms/Cubic meter (kg/m ³)	16.02
Energy	British thermal units (Btu) (1 J=Ws=0.2388 cal)	Joules (J)	1055
Force	Pounds - force (lbf) (1N=0.102 kgf)	Newtons (N)	4.448
Length	Inches (in)	Millimeters (mm)	25.4
	Feet (ft)	Meters (m)	0.3048
	Miles (mi)	Kilometers (km)	1.609
Mass (Weight)	Ounces (oz.)	Grams (g)	28.35
	Pounds - mass (lb)	Kilograms (kg)	0.4536
	Short tons (2000 lb) (tn)	Metric tons (100 kg) (t)	0.9072
Power	Horsepower (550 ft lb/s) (hp)	Kilowatts (kW)	0.7457
Pressure	Pounds/square inch (psi)	Kilograms (f)/square cm (kg(f)/cm ²)	0.7457
		Kilopascal (kPa)	0.0703
		Bars (100 kPa)	6.8948
Stress	Pounds/square inch (psi) (1N/mm ² =1MPa)	Megapascal (MPa)	0.006895
Temperature	Degrees Fahrenheit (°F)	Degrees Celsius (°C)	5/9 (after subtracting 32)
Torque or Bending Moment	Pounds-force-foot (lb-ft)	Newtons-meter (Nm)	1.3567
	Pounds-force-inch (lb-in)		0.113
Velocity	Feet/second (ft/s)	Meters/second (m/s)	0.3048
Viscosity	Dynamic (centipoise)	Pascal-second (Pas)	.001
	Kenematic - foot ² /sec (ft ² /s)	Meter ² /sec (m ² /s)	0.0929
Volume	Cubic inch (in ³)	Cubic centimeter (cm ³) (milliliter)	16.3871
	Quarts (qt)	Liters (1000 cm ³)	0.9464
	Gallons (gal)	Liters	3.7854

Metric to English			
To Convert From	To	Multiply By	
Sq. mm (mm ²)	Sq. in. (in ²)	0.00155	
Kilograms/Cubic meter (kg/m ³)	Pounds/Cubic foot (lb/ft ³)	0.0624	
Joules (J)	British Thermal Units (Btu)	0.000947	
Newtons (N)	Pounds - force (lbf)	0.2248	
Millimeters (mm)	Inches (in)	0.03937	
Meters (m)	Feet (ft)	3.281	
Kilometers (km)	Miles (mi)	0.621	
Grams (g)	Ounces (oz.)	0.035	
Kilograms (kg)	Pounds - mass (lb)	2.205	
Metric tons (100 kg) (t)	Short tons (2000 lb) (tn)	1.102	
Kilowatts (kW)	Horsepower (550 ft lb/s) (hp)	1.341	
Kilograms (f)/square cm (kg(f)/cm ²)	Pounds/square inch (psi)	14.22	
		Kilopascal (kPa)	0.145
		Bars (100 kPa)	14.503
Megapascal (MPa)	Pounds/square inch (psi) (1N/mm ² =1MPa)	145.039	
Degrees Celsius (°C)	Degrees Fahrenheit (°F)	9/5 (then add 32)	
Newtons-meter (Nm)	Pounds-force-foot (lb-ft)	0.737	
	Pounds-force-inch (lb-in)	8.85	
Meters/second (m/s)	Feet/second (ft/s)	3.2808	
Pascal-second (Pas)	Dynamic (centipoise)	1000	
Meter ² /sec (m ² /s)	Kenematic - foot ² /sec (ft ² /s)	10.7643	
Cubic centimeter (cm ³) (milliliter)	Cubic inch (in ³)	0.061	
Liters (1000 cm ³)	Quarts (qt)	1.057	
Liters	Gallons (gal)	0.2642	

Government & Agency Specifications

Hose
A

Agency and Specifications	Parflex Products
Flame Resistance:	
MSHA	D6R, HFS2R, HLB, HTB, 560TJ, 563TJ, 590TJ, 594TJ, 510A-3, 515H, 520N, 540N, 56DH-2, 575X, 580N, 83FR
UL94V-2	PEFR
UL94HB	83FR, NN, NB, NNR, NBR (wall thickness above 0.033", contact Parflex for availability)
VW1 and UL-83	All PFA, FEP & PTFE tubing products
Food Contact:	
FDA, CFR21 Part 177	E, PP, PV, 540P, 919, 919J, 919U, 929, 939, STW, SCW, SCWV, SCWV-FS, All natural and black PFA, FEP, and PTFE tubing products
NSF Standard 51*	E, PP
Potable Water:	
NSF Standard 61*	E - Tubing
Natural Gas Service: For Vehicles and Dispensing Systems	
ANSI CSA NGV 4.2; NFPA 52; CSA 12.52 Class A, Class D, Class B**	5CNG; **5CNG-8
ANSI CSA NGV 3.1; NFPA 52; CSA 12.3, Class C	CNGRP
ECE-R110	5CNG factory built assemblies
Hydraulic Service:	
SAE 100R1AT	HFSR, 560TJ
SAE 100R7	540N, 540P, 510A, 518C, 518D, 55LT, 510C (less-2)
SAE 100R8	520N, 528N, 580N, 588N, H580N
SAE 100R14A	919, 919J, 919U, 929
SAE 100R14B	919B, 929B, 929BJ
SAE 100R17	D6R, H6, R6, 563TJ
SAE 100R18	53DM, 538DM
SAE 100R19	594TJ
WASTEC WRP05:	
Waste Equipment Technology Association	S5N, S6, S9
Transportation Standards:	
SAE J844, FMVSS106 (49CFR571.106)	PFT, 1120A, 1120B, BRAKCOIL®, SliderCoil™
Electrical, Non-Conductivity:	
SAE J517	518C, 518D, 528N, 588N, 538DM
DNV (with approved fittings only)	
Det Norske (Norwegian) Veritas Marine Steel Ships, Mobile Offshore & Fixed Offshore Drilling Units	510C, 518C, 518D, 520N, 528N, 540N, 575X, 575XN, 580N, 588N, H580N
Breathing Air Applications:	
CGA (Compressed Gas Association)- G7.1-1 Grade E Breathing Air	527BA
NFPA 1901	527BA

*Indicates that products shown have been tested and certified by NSF International to the requirements of NSF Standards 51 and 61. NSF does not express or imply an approval on any product.

Agency and Specifications	Parflex Products
Aerospace Material Specifications:	
AMS 3584A	HS2TFI
AMS 3585	HS2TFT
AMS 3586	HS2TFS
AMS 3653E	101, 201, TFS, TFL, TFH, TFT, HS2TFS, HS2TFT, HS2TFL, HS2TFI, TSWTF, CV (PTFE), CVL, CVH, 81914/1, 81914/2
AMS 3655B	TFT
MIL-DTL-27267C	PTFE Conductive Tubing
AMS-DTL-23053/11A CLASS 1	HS1.3FEP
AMS-DTL-23053/11A CLASS 2	HS1.6FEP
AMS-DTL-23053/12A CLASS 1	HS2TFH
AMS-DTL-23053/12A CLASS 2	HS2TFS
AMS-DTL-23053/12A CLASS 3	HS2TFT
AMS-DTL-23053/12A CLASS 4	HS2TFL
AMS-DTL-23053/12A CLASS 5	HS2TFI
AMS-T-81914/1	81914/1
AMS-T-81914/1	81914/2
AMS-T-81914/1	81914/3
AMS-T-81914/1	81914/4
American Society for Testing and Materials:	
ASTM D2116-07	103, 203
ASTM D2902 TYPE 1	HS2TFS, HS2TFT, HS2TFL, HS2TFI, HS2TFH
ASTM D2902 TYPE II	HS1.3FEP, HS1.6FEP, HS1.25FEP
ASTM D3295	TTSWTF
ASTM D3295, Class 1	TFL
ASTM D3295, Class 2	TFT
ASTM D3295, Class 3	TFS
ASTM D3295, Class 4	TFH
ASTM D3296-03	HS1.3FEP, HS1.6FEP, CV (FEP), 81914/3, 81914/4, CR (FEP), 703
ASTM D3307-10	104, 204, 105, 205, CR (PFA), 704, 705
Canadian Standards Association:	
CSA 9032-01 300V	TFT (awg)
CSA 9032-01 600V	TFS (awg)
Military Standard - US Department of Defense:	
MIL-I-22129C	TFS
Underwriters Laboratories:	
UL-224 150V 200°C	TFL (awg)
UL-224 300V 200°C	TFT (awg)
UL-224 600V 200°C	TFS (awg)
United States Pharmacopoeia:	
USP Class VI	101, 201, TFS, TFL, TFH, TFT, HS2TFS, HS2TFT, HS2TFL, HS2TFI, HS2TFH, CV, CVL, CVH, 103, 203, HS1.3FEP, HS1.6FEP, CR, 104, 204, 105, 205, SCW, STW, SCWV, NCW

Tubing
B

Coiled Air Hose & Fittings
C

Transportation
D

Fittings
E

Tooling, Equipment & Accessories
F

General Technical
G

Parker Safety Guide

Parker Safety Guide for Selecting and Using Hose, Tubing, Fittings, Connectors, Conductors, Valves and Related Accessories



Parker Safety Guide for Selecting and Using Hose, Tubing, Fittings and Related Accessories

Publication No. 4400-B.1

Revised: October 2015, Rev A

WARNING: Failure or improper selection or improper use of hose, tubing, fittings, assemblies, valves, connectors, conductors or related accessories ("Products") can cause death, personal injury and property damage. Possible consequences of failure or improper selection or improper use of these Products include but are not limited to:

- Fittings thrown off at high speed.
- High velocity fluid discharge.
- Explosion or burning of the conveyed fluid.
- Electrocutation from high voltage electric powerlines.
- Contact with suddenly moving or falling objects that are controlled by the conveyed fluid.
- Injections by high-pressure fluid discharge.

- Dangerously whipping Hose.
- Tube or pipe burst.
- Weld joint fracture.
- Contact with conveyed fluids that may be hot, cold, toxic or otherwise injurious.
- Sparking or explosion caused by static electricity buildup or other sources of electricity.
- Sparking or explosion while spraying paint or flammable liquids.
- Injuries resulting from inhalation, ingestion or exposure to fluids.

Before selecting or using any of these Products, it is important that you read and follow the instructions below. No product from any division in Parker Fluid Connectors Group is approved for in-flight aerospace applications. For hoses and fittings used in in-flight aerospace applications, please contact Parker Aerospace Group.

1.0 GENERAL INSTRUCTIONS

1.1 Scope: This safety guide provides instructions for selecting and using (including assembling, installing, and maintaining) these Products. For convenience, all rubber and/or thermoplastic products commonly called "hose" or "tubing" are called "Hose" in this safety guide. Metallic tube or pipe are called "tube". All assemblies made with Hose are called "Hose Assemblies". All assemblies made with Tube are called "Tube Assemblies".

All products commonly called "fittings", "couplings" or "adapters" are called "Fittings". Valves are fluid system components that control the passage of fluid. Related accessories are ancillary devices that enhance or monitor performance including crimping, flaring, flanging, presetting, bending, cutting, deburring, swaging machines, sensors, tags, lockout handles, spring guards and associated tooling. This safety guide is a supplement to and is to be used with the specific Parker publications for the specific Hose, Fittings and Related Accessories that are being considered for use. Parker publications are available at www.parker.com. SAE J1273 (www.sae.org) and ISO 17165-2 (www.ansi.org) also provide recommended practices for hydraulic Hose Assemblies, and should be followed.

1.2 Fail-Safe: Hose, Hose Assemblies, Tube, Tube Assemblies and Fittings can and do fail without warning for many reasons. Design all systems and equipment in a fail-safe mode, so that failure of the Hose, Hose Assembly, Tube, Tube Assembly or Fitting will not endanger persons or property.

1.3 Distribution: Provide a copy of this safety guide to each person responsible for selecting or using Hose, Tube and Fitting products. Do not select or use Parker Hose, Tube or Fittings without thoroughly reading and understanding this safety guide as well as the specific Parker publications for the Products.

1.4 User Responsibility: Due to the wide variety of operating conditions and applications for Hose, Tube and Fittings. Parker does not represent or warrant that any particular Hose, Tube or Fitting is suitable for any specific end use system. This safety guide does not analyze all technical parameters that must be considered in selecting a product. The user, through its own analysis and testing, is solely responsible for:

- Making the final selection of the Products.
- Assuring that the user's requirements are met and that the application presents no health or safety hazards.
- Following the safety guide for Related Accessories and being trained to operate Related Accessories.
- Providing all appropriate health and safety warnings on the equipment on which the Products are used.
- Assuring compliance with all applicable government and industry standards.

1.5 Additional Questions: Call the appropriate Parker technical service department if you have any questions or require any additional information. See the Parker publication for the Products being considered or used, or call 1-800-CPARKER, or go to www.parker.com, for telephone numbers of the appropriate technical service department.

2.0 HOSE, TUBE & FITTINGS SELECTION INSTRUCTIONS

2.1 Electrical Conductivity: Certain applications require that the Hose be nonconductive to prevent electrical current flow. Other applications require the Hose and the Fittings and the Hose/Fitting interface to be sufficiently conductive to drain off static electricity. Extreme care must be exercised when selecting Hose, Tube and Fittings for these or any other applications in which electrical conductivity or nonconductivity is a factor.

The electrical conductivity or nonconductivity of Hose, Tube and Fittings is dependent upon many factors and may be susceptible to change. These factors include but are not limited to the various materials used to make the Hose and the Fittings, Fitting finish (some Fitting finishes are electrically conductive while others are nonconductive), manufacturing methods (including moisture control), how the Fittings contact the Hose, age and amount of deterioration or damage or other changes, moisture content of the Hose at any particular time, and other factors.

The following are considerations for electrically nonconductive and conductive Hose. For other applications consult the individual catalog pages and the appropriate industry or regulatory standards for proper selection.

2.1.1 Electrically Nonconductive Hose: Certain applications require that the Hose be nonconductive to prevent electrical current flow or to maintain electrical isolation. For applications that require Hose to be electrically nonconductive, including but not limited to applications near high voltage electric lines, only special nonconductive Hose can be used. The manufacturer of the equipment in which the nonconductive Hose is to be used must be consulted to be certain that the Hose, Tube and Fittings that are selected are proper for the application. Do not use any Parker Hose or Fittings for any such application requiring nonconductive Hose, including but not limited to applications near high voltage electric lines or dense magnetic fields, unless (i) the application is expressly approved in the Parker technical publication for the product, (ii) the Hose is marked "nonconductive", and (iii) the manufacturer of the equipment on which the Hose is to be used specifically approves the particular Parker Hose, Tube and Fittings for such use.

2.1.2 Electrically Conductive Hose: Parker manufactures special Hose for certain applications that require electrically conductive Hose. Parker manufactures special Hose for conveying paint in airless paint spraying applications. This Hose is labeled "Electrically Conductive Airless Paint Spray Hose" on its layline and packaging. This Hose must be properly connected to the appropriate Parker Fittings and properly grounded in order to dissipate dangerous static charge buildup, which occurs in all airless paint spraying applications. Do not use any other Hose for airless paint spraying, even if electrically conductive. Use of any other Hose or failure to properly connect the Hose can cause a fire or an explosion resulting in death, personal injury, and property damage. All hoses that convey fuels must be grounded.

Parker manufactures a special Hose for certain compressed natural gas ("CNG") applications where static electricity buildup may occur. Parker CNG Hose assemblies comply with the requirements of ANSI/IAS NGV 4.2; CSA 12.52, "Hoses for Natural Gas Vehicles and Dispensing Systems" (www.ansi.org). This Hose is labeled "Electrically Conductive for CNG Use"

on its layline and packaging. This Hose must be properly connected to the appropriate Parker Fittings and properly grounded in order to dissipate dangerous static charge buildup, which occurs in, for example, high velocity CNG dispensing or transfer. Do not use any other Hose for CNG applications where static charge buildup may occur, even if electrically conductive. Use of other Hoses in CNG applications or failure to properly connect or ground this Hose can cause a fire or an explosion resulting in death, personal injury, and property damage. Care must also be taken to protect against CNG permeation through the Hose wall. See section 2.6, Permeation, for more information. Parker CNG Hose is intended for dispenser and vehicle use within the specified temperature range. Parker CNG Hose should not be used in confined spaces or unventilated areas or areas exceeding the specified temperature range. Final assemblies must be tested for leaks. CNG Hose Assemblies should be tested on a monthly basis for conductivity per ANSI/IAS NGV 4.2; CSA 12.52.

Parker manufactures special Hose for aerospace in-flight applications. Aerospace in-flight applications employing Hose to transmit fuel, lubricating fluids and hydraulic fluids require a special Hose with a conductive inner tube. This Hose for in-flight applications is available only from Parker's Stratoflex Products Division. Do not use any other Parker Hose for in-flight applications, even if electrically conductive. Use of other Hoses for in-flight applications or failure to properly connect or ground this Hose can cause a fire or an explosion resulting in death, personal injury and property damage. These Hose assemblies for in-flight applications must meet all applicable aerospace industry, aircraft engine and aircraft requirements .

2.2 Pressure: Hose, Tube and Fitting selection must be made so that the published maximum working pressure of the Hose, Tube and Fittings are equal to or greater than the maximum system pressure. The maximum working pressure of a Hose, or Tube Assembly is the lower of the respective published maximum working pressures of the Hose, Tube and the Fittings used. Surge pressures or peak transient pressures in the system must be below the published maximum working pressure for the Hose, Tube and Fitting. Surge pressures and peak pressures can usually only be determined by sensitive electrical instrumentation that measures and indicates pressures at millisecond intervals. Mechanical pressure gauges indicate only average pressures and cannot be used to determine surge pressures or peak transient pressures. Published burst pressure ratings for Hose is for manufacturing test purposes only and is no indication that the Product can be used in applications at the burst pressure or otherwise above the published maximum recommended working pressure.

2.3 Suction: Hoses used for suction applications must be selected to insure that the Hose will withstand the vacuum and pressure of the system. Improperly selected Hose may collapse in suction application.

2.4 Temperature: Be certain that fluid and ambient temperatures, both steady and transient, do not exceed the limitations of the Hose, Tube, Fitting and Seals. Temperatures below and above the recommended limit can degrade Hose, Tube, Fittings and Seals to a point where a failure may occur and release fluid. Tube and Fittings performances are normally degraded at elevated temperature. Material compatibility can also change at temperatures outside of the rated range. Properly insulate and protect the Hose Assembly when routing near hot objects (e.g. manifolds). Do not use any Hose in any application where failure of the Hose could result in the conveyed fluids (or vapors or mist from the conveyed fluids) contacting any open flame, molten metal, or other potential fire ignition source that could cause burning or explosion of the conveyed fluids or vapors.

2.5 Fluid Compatibility: Hose, and Tube Assembly selection must assure compatibility of the Hose tube, cover, reinforcement, Tube, Plating and Seals with the fluid media used. See the fluid compatibility chart in the Parker publication for the product being considered or used. This information is offered only as a guide. Actual service life can only be determined by the end user by testing under all extreme conditions and other analysis.

Hose, and Tube that is chemically compatible with a particular fluid must be assembled using Fittings and adapters containing likewise compatible seals. Flange or flare processes can change Tube material properties that may not be compatible with certain requirements such as NACE

2.6 Permeation: Permeation (that is, seepage through the Hose or Seal) will occur from inside the Hose or Fitting to outside when Hose or Fitting is used with gases, liquid and gas fuels, and refrigerants (including but not limited to such materials as helium, diesel fuel, gasoline, natural gas, or LPG). This permeation may result in high concentrations of vapors which are potentially flammable, explosive, or toxic, and in loss of fluid. Dangerous explosions, fires, and other hazards can result when using the wrong Hose for such applications. The system designer must take into account the fact that this permeation will take place and

must not use Hose or Fitting if this permeation could be hazardous. The system designer must take into account all legal, government, insurance, or any other special regulations which govern the use of fuels and refrigerants. Never use a Hose or Fitting even though the fluid compatibility is acceptable without considering the potential hazardous effects that can result from permeation through the Hose or Tube Assembly. Permeation of moisture from outside the Hose or Fitting to inside the Hose or Fitting will also occur in Hose or Tube assemblies, regardless of internal pressure. If this moisture permeation would have detrimental effects (particularly, but not limited to refrigeration and air conditioning systems), incorporation of sufficient drying capacity in the system or other appropriate system safeguards should be selected and used. The sudden pressure release of highly pressurized gas could also result in Explosive Decompression failure of permeated Seals and Hoses.

2.7 Size: Transmission of power by means of pressurized fluid varies with pressure and rate of flow. The size of the components must be adequate to keep pressure losses to a minimum and avoid damage due to heat generation or excessive fluid velocity.

2.8 Routing: Attention must be given to optimum routing to minimize inherent problems (kinking or flow restriction due to Hose collapse, twisting of the Hose, proximity to hot objects or heat sources). For additional routing recommendations see SAE J1273 and ISO 17165-2. Hose Assemblies have a finite life and should be installed in a manner that allows for ease of inspection and future replacement. Hose because of its relative short life, should not be used in residential and commercial buildings inside of inaccessible walls or floors, unless specifically allowed in the product literature. Always review all product literature for proper installation and routing instructions.

2.9 Environment: Care must be taken to insure that the Hose, Tube and Fittings are either compatible with or protected from the environment (that is, surrounding conditions) to which they are exposed. Environmental conditions including but not limited to ultraviolet radiation, sunlight, heat, ozone, moisture, water, salt water, chemicals and air pollutants can cause degradation and premature failure.

2.10 Mechanical Loads: External forces can significantly reduce Hose, Tube and Fitting life or cause failure. Mechanical loads which must be considered include excessive flexing, twist, kinking, tensile or side loads, bend radius, and vibration. Use of swivel type Fittings or adapters may be required to insure no twist is put into the Hose. Use of proper Hose or Tube clamps may also be required to reduce external mechanical loads. Unusual applications may require special testing prior to Hose selection.

2.11 Physical Damage: Care must be taken to protect Hose from wear, snagging, kinking, bending smaller than minimum bend radius and cutting, any of which can cause premature Hose failure. Any Hose that has been kinked or bent to a radius smaller than the minimum bend radius, and any Hose that has been cut or is cracked or is otherwise damaged should be removed and discarded. Fittings with damages such as scratches on sealing surfaces and deformation should be replaced.

2.12 Proper End Fitting: See instructions 3.2 through 3.5. These recommendations may be substantiated by testing to industry standards such as SAE J517 for hydraulic applications, or MIL-A-5070, AS1339, or AS3517 for Hoses from Parker's Stratoflex Products Division for aerospace applications.

2.13 Length: When determining the proper Hose or Tube length of an assembly, be aware of Hose length change due to pressure, Tube length change due to thermal expansion or contraction, and Hose or Tube and machine tolerances and movement must be considered. When routing short hose assemblies, it is recommended that the minimum free hose length is always used. Consult the hose manufacturer for their minimum free hose length recommendations. Hose assemblies should be installed in such a way that any motion or flexing occurs within the same plane.

2.14 Specifications and Standards: When selecting Hose, Tube and Fittings, government, industry, and Parker specifications and recommendations must be reviewed and followed as applicable.

2.15 Hose Cleanliness: Hose and Tube components may vary in cleanliness levels. Care must be taken to insure that the Hose and Tube Assembly selected has an adequate level of cleanliness for the application.

2.16 Fire Resistant Fluids: Some fire resistant fluids that are to be conveyed by Hose or Tube require use of the same type of Hose or Tube as used with petroleum base fluids. Some such fluids require a special Hose, Tube, Fitting and Seal, while a few fluids will not work with any Hose at all. See instructions 2.5 and 1.5. The wrong Hose, Tube, Fitting or Seal may fail after a very short service. In addition, all liquids but pure water may burn fiercely under certain conditions, and even pure water leakage may be hazardous.

A Hose

B Tubing

C Coiled Air Hose & Fittings

D Transportation

E Fittings

F Tooling, Equipment & Accessories

G General Technical

A Hose	<p>2.17 Radiant Heat: Hose and Seals can be heated to destruction without contact by such nearby items as hot manifolds or molten metal. The same heat source may then initiate a fire. This can occur despite the presence of cool air around the Hose or Seal. Performance of Tube and Fitting subjected to the heat could be degraded.</p> <p>2.18 Welding or Brazing: When using a torch or arc welder in close proximity to hydraulic lines, the hydraulic lines should be removed or shielded with appropriate fire resistant materials. Flame or weld spatter could burn through the Hose or Seal and possibly ignite escaping fluid resulting in a catastrophic failure. Heating of plated parts, including Hose Fittings and adapters, above 450°F (232°C) such as during welding, brazing or soldering may emit deadly gases. Any elastomer seal on fittings shall be removed prior to welding or brazing, any metallic surfaces shall be protected after brazing or welding when necessary. Welding and brazing filler material shall be compatible with the Tube and Fitting that are joined.</p> <p>2.19 Atomic Radiation: Atomic radiation affects all materials used in Hose and Tube assemblies. Since the long-term effects may be unknown, do not expose Hose or Tube assemblies to atomic radiation. Nuclear applications may require special Tube and Fittings.</p> <p>2.20 Aerospace Applications: The only Hose, Tube and Fittings that may be used for in-flight aerospace applications are those available from Parker's Stratoflex Products Division. Do not use any other Hose or Fittings for in-flight applications. Do not use any Hose or Fittings from Parker's Stratoflex Products Division with any other Hose or Fittings, unless expressly approved in writing by the engineering manager or chief engineer of Stratoflex Products Division and verified by the user's own testing and inspection to aerospace industry standards.</p> <p>2.21 Unlocking Couplings: Ball locking couplings or other Fittings with quick disconnect ability can unintentionally disconnect if they are dragged over obstructions, or if the sleeve or other disconnect member, is bumped or moved enough to cause disconnect. Threaded Fittings should be considered where there is a potential for accidental uncoupling.</p>	<p>Hose Assemblies may only be reused after proper inspection under section 4.0. Do not assemble Fittings to any previously used hydraulic Hose that was in service, for use in a fluid power application.</p> <p>3.6 Pre-Installation Inspection: Prior to installation, a careful examination of the Hose Assembly must be performed. Inspect the Hose Assembly for any damage or defects. DO NOT use any Hose Assembly that displays any signs of nonconformance.</p> <p>3.7 Minimum Bend Radius: Installation of a Hose at less than the minimum listed bend radius may significantly reduce the Hose life. Particular attention must be given to preclude sharp bending at the Hose to Fitting juncture. Any bending during installation at less than the minimum bend radius must be avoided. If any Hose is kinked during installation, the Hose must be discarded.</p> <p>3.8 Twist Angle and Orientation: Hose Assembly installation must be such that relative motion of machine components does not produce twisting.</p> <p>3.9 Securement: In many applications, it may be necessary to restrain, protect, or guide the Hose to protect it from damage by unnecessary flexing, pressure surges, and contact with other mechanical components. Care must be taken to insure such restraints do not introduce additional stress or wear points.</p> <p>3.10 Proper Connection of Ports: Proper physical installation of the Hose Assembly requires a correctly installed port connection insuring that no twist or torque is transferred to the Hose when the Fittings are being tightened or otherwise during use.</p> <p>3.11 External Damage: Proper installation is not complete without insuring that tensile loads, side loads, kinking, flattening, potential abrasion, thread damage or damage to sealing surfaces are corrected or eliminated. See instruction 2.10.</p> <p>3.12 System Checkout: All air entrapment must be eliminated and the system pressurized to the maximum system pressure (at or below the Hose maximum working pressure) and checked for proper function and freedom from leaks. Personnel must stay out of potential hazardous areas while testing and using.</p> <p>3.13 Routing: The Hose Assembly should be routed in such a manner so if a failure does occur, the escaping media will not cause personal injury or property damage. In addition, if fluid media comes in contact with hot surfaces, open flame or sparks, a fire or explosion may occur. See section 2.4.</p> <p>3.14 Ground Fault Equipment Protection Devices (GFEPDs): WARNING! Fire and Shock Hazard. To minimize the danger of fire if the heating cable of a Multitube bundle is damaged or improperly installed, use a Ground Fault Equipment Protection Device. Electrical fault currents may be insufficient to trip a conventional circuit breaker.</p> <p>For ground fault protection, the IEEE 515: (www.ansi.org) standard for heating cables recommends the use of GFEPDs with a nominal 30 milliampere trip level for "piping systems in classified areas, those areas requiring a high degree of maintenance, or which may be exposed to physical abuse or corrosive atmospheres".</p>
B Tubing	<p>2.21 Atomic Radiation: Atomic radiation affects all materials used in Hose and Tube assemblies. Since the long-term effects may be unknown, do not expose Hose or Tube assemblies to atomic radiation. Nuclear applications may require special Tube and Fittings.</p> <p>2.20 Aerospace Applications: The only Hose, Tube and Fittings that may be used for in-flight aerospace applications are those available from Parker's Stratoflex Products Division. Do not use any other Hose or Fittings for in-flight applications. Do not use any Hose or Fittings from Parker's Stratoflex Products Division with any other Hose or Fittings, unless expressly approved in writing by the engineering manager or chief engineer of Stratoflex Products Division and verified by the user's own testing and inspection to aerospace industry standards.</p> <p>2.21 Unlocking Couplings: Ball locking couplings or other Fittings with quick disconnect ability can unintentionally disconnect if they are dragged over obstructions, or if the sleeve or other disconnect member, is bumped or moved enough to cause disconnect. Threaded Fittings should be considered where there is a potential for accidental uncoupling.</p>	<p>3.6 Pre-Installation Inspection: Prior to installation, a careful examination of the Hose Assembly must be performed. Inspect the Hose Assembly for any damage or defects. DO NOT use any Hose Assembly that displays any signs of nonconformance.</p> <p>3.7 Minimum Bend Radius: Installation of a Hose at less than the minimum listed bend radius may significantly reduce the Hose life. Particular attention must be given to preclude sharp bending at the Hose to Fitting juncture. Any bending during installation at less than the minimum bend radius must be avoided. If any Hose is kinked during installation, the Hose must be discarded.</p> <p>3.8 Twist Angle and Orientation: Hose Assembly installation must be such that relative motion of machine components does not produce twisting.</p> <p>3.9 Securement: In many applications, it may be necessary to restrain, protect, or guide the Hose to protect it from damage by unnecessary flexing, pressure surges, and contact with other mechanical components. Care must be taken to insure such restraints do not introduce additional stress or wear points.</p> <p>3.10 Proper Connection of Ports: Proper physical installation of the Hose Assembly requires a correctly installed port connection insuring that no twist or torque is transferred to the Hose when the Fittings are being tightened or otherwise during use.</p> <p>3.11 External Damage: Proper installation is not complete without insuring that tensile loads, side loads, kinking, flattening, potential abrasion, thread damage or damage to sealing surfaces are corrected or eliminated. See instruction 2.10.</p> <p>3.12 System Checkout: All air entrapment must be eliminated and the system pressurized to the maximum system pressure (at or below the Hose maximum working pressure) and checked for proper function and freedom from leaks. Personnel must stay out of potential hazardous areas while testing and using.</p> <p>3.13 Routing: The Hose Assembly should be routed in such a manner so if a failure does occur, the escaping media will not cause personal injury or property damage. In addition, if fluid media comes in contact with hot surfaces, open flame or sparks, a fire or explosion may occur. See section 2.4.</p> <p>3.14 Ground Fault Equipment Protection Devices (GFEPDs): WARNING! Fire and Shock Hazard. To minimize the danger of fire if the heating cable of a Multitube bundle is damaged or improperly installed, use a Ground Fault Equipment Protection Device. Electrical fault currents may be insufficient to trip a conventional circuit breaker.</p> <p>For ground fault protection, the IEEE 515: (www.ansi.org) standard for heating cables recommends the use of GFEPDs with a nominal 30 milliampere trip level for "piping systems in classified areas, those areas requiring a high degree of maintenance, or which may be exposed to physical abuse or corrosive atmospheres".</p>
C Coiled Air Hose & Fittings	<p>2.21 Unlocking Couplings: Ball locking couplings or other Fittings with quick disconnect ability can unintentionally disconnect if they are dragged over obstructions, or if the sleeve or other disconnect member, is bumped or moved enough to cause disconnect. Threaded Fittings should be considered where there is a potential for accidental uncoupling.</p>	<p>3.6 Pre-Installation Inspection: Prior to installation, a careful examination of the Hose Assembly must be performed. Inspect the Hose Assembly for any damage or defects. DO NOT use any Hose Assembly that displays any signs of nonconformance.</p> <p>3.7 Minimum Bend Radius: Installation of a Hose at less than the minimum listed bend radius may significantly reduce the Hose life. Particular attention must be given to preclude sharp bending at the Hose to Fitting juncture. Any bending during installation at less than the minimum bend radius must be avoided. If any Hose is kinked during installation, the Hose must be discarded.</p> <p>3.8 Twist Angle and Orientation: Hose Assembly installation must be such that relative motion of machine components does not produce twisting.</p> <p>3.9 Securement: In many applications, it may be necessary to restrain, protect, or guide the Hose to protect it from damage by unnecessary flexing, pressure surges, and contact with other mechanical components. Care must be taken to insure such restraints do not introduce additional stress or wear points.</p> <p>3.10 Proper Connection of Ports: Proper physical installation of the Hose Assembly requires a correctly installed port connection insuring that no twist or torque is transferred to the Hose when the Fittings are being tightened or otherwise during use.</p> <p>3.11 External Damage: Proper installation is not complete without insuring that tensile loads, side loads, kinking, flattening, potential abrasion, thread damage or damage to sealing surfaces are corrected or eliminated. See instruction 2.10.</p> <p>3.12 System Checkout: All air entrapment must be eliminated and the system pressurized to the maximum system pressure (at or below the Hose maximum working pressure) and checked for proper function and freedom from leaks. Personnel must stay out of potential hazardous areas while testing and using.</p> <p>3.13 Routing: The Hose Assembly should be routed in such a manner so if a failure does occur, the escaping media will not cause personal injury or property damage. In addition, if fluid media comes in contact with hot surfaces, open flame or sparks, a fire or explosion may occur. See section 2.4.</p> <p>3.14 Ground Fault Equipment Protection Devices (GFEPDs): WARNING! Fire and Shock Hazard. To minimize the danger of fire if the heating cable of a Multitube bundle is damaged or improperly installed, use a Ground Fault Equipment Protection Device. Electrical fault currents may be insufficient to trip a conventional circuit breaker.</p> <p>For ground fault protection, the IEEE 515: (www.ansi.org) standard for heating cables recommends the use of GFEPDs with a nominal 30 milliampere trip level for "piping systems in classified areas, those areas requiring a high degree of maintenance, or which may be exposed to physical abuse or corrosive atmospheres".</p>
D Transportation	<p>3.0 HOSE AND FITTINGS ASSEMBLY AND INSTALLATION INSTRUCTIONS</p> <p>3.1 Component Inspection: Prior to assembly, a careful examination of the Hose and Fittings must be performed. All components must be checked for correct style, size, catalog number, and length. The Hose must be examined for cleanliness, obstructions, blisters, cover looseness, kinks, cracks, cuts or any other visible defects. Inspect the Fitting and sealing surfaces for burrs, nicks, corrosion or other imperfections. Do NOT use any component that displays any signs of nonconformance.</p> <p>3.2 Hose and Fitting Assembly: Do not assemble a Parker Fitting on a Parker Hose that is not specifically listed by Parker for that Fitting, unless authorized in writing by the engineering manager or chief engineer of the appropriate Parker division. Do not assemble a Parker Fitting on another manufacturer's Hose or a Parker Hose on another manufacturer's Fitting unless (i) the engineering manager or chief engineer of the appropriate Parker division approves the Assembly in writing or that combination is expressly approved in the appropriate Parker literature for the specific Parker product, and (ii) the user verifies the Assembly and the application through analysis and testing. For Parker Hose that does not specify a Parker Fitting, the user is solely responsible for the selection of the proper Fitting and Hose Assembly procedures. See instruction 1.4.</p> <p>To prevent the possibility of problems such as leakage at the Fitting or system contamination, it is important to completely remove all debris from the cutting operation before installation of the Fittings. The Parker published instructions must be followed for assembling the Fittings on the Hose. These instructions are provided in the Parker Fitting catalog for the specific Parker Fitting being used, or by calling 1-800-CPARKER, or at www.parker.com.</p> <p>3.3 Related Accessories: Do not crimp or swage any Parker Hose or Fitting with anything but the listed swage or crimp machine and dies in accordance with Parker published instructions. Do not crimp or swage another manufacturer's Fitting with a Parker crimp or swage die unless authorized in writing by the engineering manager or chief engineer of the appropriate Parker division.</p> <p>3.4 Parts: Do not use any Parker Fitting part (including but not limited to socket, shell, nipple, or insert) except with the correct Parker mating parts, in accordance with Parker published instructions, unless authorized in writing by the engineering manager or chief engineer of the appropriate Parker division.</p> <p>3.5 Field Attachable/Permanent: Do not reuse any field attachable Hose Fitting that has blown or pulled off a Hose. Do not reuse a Parker permanent Hose Fitting (crimped or swaged) or any part thereof. Complete</p>	<p>3.6 Pre-Installation Inspection: Prior to installation, a careful examination of the Hose Assembly must be performed. Inspect the Hose Assembly for any damage or defects. DO NOT use any Hose Assembly that displays any signs of nonconformance.</p> <p>3.7 Minimum Bend Radius: Installation of a Hose at less than the minimum listed bend radius may significantly reduce the Hose life. Particular attention must be given to preclude sharp bending at the Hose to Fitting juncture. Any bending during installation at less than the minimum bend radius must be avoided. If any Hose is kinked during installation, the Hose must be discarded.</p> <p>3.8 Twist Angle and Orientation: Hose Assembly installation must be such that relative motion of machine components does not produce twisting.</p> <p>3.9 Securement: In many applications, it may be necessary to restrain, protect, or guide the Hose to protect it from damage by unnecessary flexing, pressure surges, and contact with other mechanical components. Care must be taken to insure such restraints do not introduce additional stress or wear points.</p> <p>3.10 Proper Connection of Ports: Proper physical installation of the Hose Assembly requires a correctly installed port connection insuring that no twist or torque is transferred to the Hose when the Fittings are being tightened or otherwise during use.</p> <p>3.11 External Damage: Proper installation is not complete without insuring that tensile loads, side loads, kinking, flattening, potential abrasion, thread damage or damage to sealing surfaces are corrected or eliminated. See instruction 2.10.</p> <p>3.12 System Checkout: All air entrapment must be eliminated and the system pressurized to the maximum system pressure (at or below the Hose maximum working pressure) and checked for proper function and freedom from leaks. Personnel must stay out of potential hazardous areas while testing and using.</p> <p>3.13 Routing: The Hose Assembly should be routed in such a manner so if a failure does occur, the escaping media will not cause personal injury or property damage. In addition, if fluid media comes in contact with hot surfaces, open flame or sparks, a fire or explosion may occur. See section 2.4.</p> <p>3.14 Ground Fault Equipment Protection Devices (GFEPDs): WARNING! Fire and Shock Hazard. To minimize the danger of fire if the heating cable of a Multitube bundle is damaged or improperly installed, use a Ground Fault Equipment Protection Device. Electrical fault currents may be insufficient to trip a conventional circuit breaker.</p> <p>For ground fault protection, the IEEE 515: (www.ansi.org) standard for heating cables recommends the use of GFEPDs with a nominal 30 milliampere trip level for "piping systems in classified areas, those areas requiring a high degree of maintenance, or which may be exposed to physical abuse or corrosive atmospheres".</p>
E Fittings	<p>To prevent the possibility of problems such as leakage at the Fitting or system contamination, it is important to completely remove all debris from the cutting operation before installation of the Fittings. The Parker published instructions must be followed for assembling the Fittings on the Hose. These instructions are provided in the Parker Fitting catalog for the specific Parker Fitting being used, or by calling 1-800-CPARKER, or at www.parker.com.</p> <p>3.3 Related Accessories: Do not crimp or swage any Parker Hose or Fitting with anything but the listed swage or crimp machine and dies in accordance with Parker published instructions. Do not crimp or swage another manufacturer's Fitting with a Parker crimp or swage die unless authorized in writing by the engineering manager or chief engineer of the appropriate Parker division.</p> <p>3.4 Parts: Do not use any Parker Fitting part (including but not limited to socket, shell, nipple, or insert) except with the correct Parker mating parts, in accordance with Parker published instructions, unless authorized in writing by the engineering manager or chief engineer of the appropriate Parker division.</p> <p>3.5 Field Attachable/Permanent: Do not reuse any field attachable Hose Fitting that has blown or pulled off a Hose. Do not reuse a Parker permanent Hose Fitting (crimped or swaged) or any part thereof. Complete</p>	<p>4.0 TUBE AND FITTINGS ASSEMBLY AND INSTALLATION INSTRUCTIONS</p> <p>4.1 Component Inspection: Prior to assembly, a careful examination of the Tube and Fittings must be performed. All components must be checked for correct style, size, material, seal, and length. Inspect the Fitting and sealing surfaces for burrs, nicks, corrosion, missing seal or other imperfections. Do NOT use any component that displays any signs of nonconformance.</p> <p>4.2 Tube and Fitting Assembly: Do not assemble a Parker Fitting with a Tube that is not specifically listed by Parker for that Fitting, unless authorized in writing by the engineering manager or chief engineer of the appropriate Parker division. The Tube must meet the requirements specified to the Fitting. The Parker published instructions must be followed for assembling the Fittings to a Tube. These instructions are provided in the Parker Fitting catalog for the specific Parker Fitting being used, or by calling 1-800-CPARKER, or at www.parker.com.</p> <p>4.3 Related Accessories: Do not preset or flange Parker Fitting components using another manufacturer's equipment or procedures unless authorized in writing by the engineering manager or chief engineer of the appropriate Parker division. Tube, Fitting component and tooling must be checked for correct style, size and material. Operation and maintenance of Related Accessories must be in accordance with the operation manual for the designated Accessory.</p> <p>4.4 Securement: In many applications, it may be necessary to restrain, protect, or guide the Tube to protect it from damage by unnecessary flexing, pressure surges, vibration, and contact with other mechanical components. Care must be taken to insure such restraints do not introduce additional stress or wear points.</p>
F Tooling, Equipment & Accessories	<p>3.3 Related Accessories: Do not crimp or swage any Parker Hose or Fitting with anything but the listed swage or crimp machine and dies in accordance with Parker published instructions. Do not crimp or swage another manufacturer's Fitting with a Parker crimp or swage die unless authorized in writing by the engineering manager or chief engineer of the appropriate Parker division.</p> <p>3.4 Parts: Do not use any Parker Fitting part (including but not limited to socket, shell, nipple, or insert) except with the correct Parker mating parts, in accordance with Parker published instructions, unless authorized in writing by the engineering manager or chief engineer of the appropriate Parker division.</p> <p>3.5 Field Attachable/Permanent: Do not reuse any field attachable Hose Fitting that has blown or pulled off a Hose. Do not reuse a Parker permanent Hose Fitting (crimped or swaged) or any part thereof. Complete</p>	<p>4.1 Component Inspection: Prior to assembly, a careful examination of the Tube and Fittings must be performed. All components must be checked for correct style, size, material, seal, and length. Inspect the Fitting and sealing surfaces for burrs, nicks, corrosion, missing seal or other imperfections. Do NOT use any component that displays any signs of nonconformance.</p> <p>4.2 Tube and Fitting Assembly: Do not assemble a Parker Fitting with a Tube that is not specifically listed by Parker for that Fitting, unless authorized in writing by the engineering manager or chief engineer of the appropriate Parker division. The Tube must meet the requirements specified to the Fitting. The Parker published instructions must be followed for assembling the Fittings to a Tube. These instructions are provided in the Parker Fitting catalog for the specific Parker Fitting being used, or by calling 1-800-CPARKER, or at www.parker.com.</p> <p>4.3 Related Accessories: Do not preset or flange Parker Fitting components using another manufacturer's equipment or procedures unless authorized in writing by the engineering manager or chief engineer of the appropriate Parker division. Tube, Fitting component and tooling must be checked for correct style, size and material. Operation and maintenance of Related Accessories must be in accordance with the operation manual for the designated Accessory.</p> <p>4.4 Securement: In many applications, it may be necessary to restrain, protect, or guide the Tube to protect it from damage by unnecessary flexing, pressure surges, vibration, and contact with other mechanical components. Care must be taken to insure such restraints do not introduce additional stress or wear points.</p>
G General Technical	<p>3.5 Field Attachable/Permanent: Do not reuse any field attachable Hose Fitting that has blown or pulled off a Hose. Do not reuse a Parker permanent Hose Fitting (crimped or swaged) or any part thereof. Complete</p>	<p>4.4 Securement: In many applications, it may be necessary to restrain, protect, or guide the Tube to protect it from damage by unnecessary flexing, pressure surges, vibration, and contact with other mechanical components. Care must be taken to insure such restraints do not introduce additional stress or wear points.</p>

4.5 Proper Connection of Ports: Proper physical installation of the Tube Assembly requires a correctly installed port connection insuring that no torque is transferred to the Tube when the Fittings are being tightened or otherwise during use.

4.6 External Damage: Proper installation is not complete without insuring that tensile loads, side loads, flattening, potential abrasion, thread damage or damage to sealing surfaces are corrected or eliminated. See instruction 2.10.

4.7 System Checkout: All air entrapment must be eliminated and the system pressurized to the maximum system pressure (at or below the Tube Assembly maximum working pressure) and checked for proper function and freedom from leaks. Personnel must stay out of potential hazardous areas while testing and using.

4.8 Routing: The Tube Assembly should be routed in such a manner so if a failure does occur, the escaping media will not cause personal injury or property damage. In addition, if fluid media comes in contact with hot surfaces, open flame or sparks, a fire or explosion may occur. See section 2.4.

5.0 HOSE AND FITTING MAINTENANCE AND REPLACEMENT INSTRUCTIONS

5.1 Even with proper selection and installation, Hose life may be significantly reduced without a continuing maintenance program. The severity of the application, risk potential from a possible Hose failure, and experience with any Hose failures in the application or in similar applications should determine the frequency of the inspection and the replacement for the Products so that Products are replaced before any failure occurs. Certain products require maintenance and inspection per industry requirements. Failure to adhere to these requirements may lead to premature failure. A maintenance program must be established and followed by the user and, at minimum, must include instructions 5.2 through 5.7

5.2 Visual Inspection Hose/Fitting: Any of the following conditions require immediate shut down and replacement of the Hose Assembly:

- Fitting slippage on Hose;
- Damaged, cracked, cut or abraded cover (any reinforcement exposed);
- Hard, stiff, heat cracked, or charred Hose;
- Cracked, damaged, or badly corroded Fittings;
- Leaks at Fitting or in Hose;
- Kinked, crushed, flattened or twisted Hose; and
- Blistered, soft, degraded, or loose cover.

5.3 Visual Inspection All Other: The following items must be tightened, repaired, corrected or replaced as required:

- Leaking port conditions;
- Excess dirt buildup;/
- Worn clamps, guards or shields; and
- System fluid level, fluid type, and any air entrapment.

5.4 Functional Test: Operate the system at maximum operating pressure and check for possible malfunctions and leaks. Personnel must avoid potential hazardous areas while testing and using the system. See section 2.2.

5.5 Replacement Intervals: Hose assemblies and elastomeric seals used on Hose Fittings and adapters will eventually age, harden, wear and deteriorate under thermal cycling and compression set. Hose Assemblies and elastomeric seals should be inspected and replaced at specific replacement intervals, based on previous service life, government or industry recommendations, or when failures could result in unacceptable downtime, damage, or injury risk. See section 1.2. Hose and Fittings may be subjected to internal mechanical and/or chemical wear from the conveying fluid and may fail without warning. The user must determine the product life under such circumstances by testing. Also see section 2.5.

5.6 Hose Inspection and Failure: Hydraulic power is accomplished by utilizing high pressure fluids to transfer energy and do work. Hoses, Fittings and Hose Assemblies all contribute to this by transmitting fluids at high pressures. Fluids under pressure can be dangerous and potentially lethal and, therefore, extreme caution must be exercised when

working with fluids under pressure and handling the Hoses transporting the fluids. From time to time, Hose Assemblies will fail if they are not replaced at proper time intervals. Usually these failures are the result of some form of misapplication, abuse, wear or failure to perform proper maintenance. When Hoses fail, generally the high pressure fluids inside escape in a stream which may or may not be visible to the user. Under no circumstances should the user attempt to locate the leak by "feeling" with their hands or any other part of their body. High pressure fluids can and will penetrate the skin and cause severe tissue damage and possibly loss of limb. Even seemingly minor hydraulic fluid injection injuries must be treated immediately by a physician with knowledge of the tissue damaging properties of hydraulic fluid.

If a Hose failure occurs, immediately shut down the equipment and leave the area until pressure has been completely released from the Hose Assembly. Simply shutting down the hydraulic pump may or may not eliminate the pressure in the Hose Assembly. Many times check valves, etc., are employed in a system and can cause pressure to remain in a Hose Assembly even when pumps or equipment are not operating. Tiny holes in the Hose, commonly known as pinholes, can eject small, dangerously powerful but hard to see streams of hydraulic fluid. It may take several minutes or even hours for the pressure to be relieved so that the Hose Assembly may be examined safely.

Once the pressure has been reduced to zero, the Hose Assembly may be taken off the equipment and examined. It must always be replaced if a failure has occurred. Never attempt to patch or repair a Hose Assembly that has failed. Consult the nearest Parker distributor or the appropriate Parker division for Hose Assembly replacement information. . Never touch or examine a failed Hose Assembly unless it is obvious that the Hose no longer contains fluid under pressure. The high pressure fluid is extremely dangerous and can cause serious and potentially fatal injury.

5.7 Elastomeric seals: Elastomeric seals will eventually age, harden, wear and deteriorate under thermal cycling and compression set. Elastomeric seals should be inspected and replaced.

5.8 Refrigerant gases: Special care should be taken when working with refrigeration systems. Sudden escape of refrigerant gases can cause blindness if the escaping gases contact the eye and can cause freezing or other severe injuries if it contacts any other portion of the body.

5.9 Compressed natural gas (CNG): Parker CNG Hose Assemblies should be tested after installation and before use, and at least on a monthly basis per instructions provided on the Hose Assembly tag. The recommended procedure is to pressurize the Hose and check for leaks and to visually inspect the Hose for damage and to perform an electrical resistance test.

Caution: Matches, candles, open flame or other sources of ignition shall not be used for Hose inspection. Leak check solutions should be rinsed off after use.

6.0 HOSE STORAGE

6.1 Age Control: Hose and Hose Assemblies must be stored in a manner that facilitates age control and first-in and first-out usage based on manufacturing date of the Hose and Hose Assemblies. Unless otherwise specified by the manufacturer or defined by local laws and regulations:

6.1.1 The shelf life of rubber hose in bulk form or hose made from two or more materials is 28 quarters (7 years) from the date of manufacture, with an extension of 12 quarters (3 years), if stored in accordance with ISO 2230;

6.1.2 The shelf life of thermoplastic and polytetrafluoroethylene hose is considered to be unlimited;

6.1.3 Hose assemblies that pass visual inspection and proof test shall not be stored for longer than 2 years.

6.1.4 Storage: Stored Hose and Hose Assemblies must not be subjected to damage that could reduce their expected service life and must be placed in a cool, dark and dry area with the ends capped. Stored Hose and Hose Assemblies must not be exposed to temperature extremes, ozone, oils, corrosive liquids or fumes, solvents, high humidity, rodents, insects, ultraviolet light, electromagnetic fields or radioactive materials.

A Hose

B Tubing

C Coiled Air Hose & Fittings

D Transportation

E Fittings

F Tooling, Equipment & Accessories

G General Technical

ENERPAC Warranty Policy

For those ENERPAC items sold as part of the Parker Parflex Division product offering, the following warranty applies.

ENERPAC products are warranted to be free of defects in materials and workmanship under normal use for as long as they are owned by the original purchaser, subject to the exclusions and limitations described below. This warranty does not cover ordinary wear and tear, overloading, alterations, (including repairs or attempted repairs by parties other than ENERPAC or its authorized service representatives), improper fluid, use in a manner for which they are not intended or use which is contrary to instructions for the products.

THE FOREGOING WARRANTY IS EXCLUSIVE AND IS IN LIEU OF ALL OTHER EXPRESS AND IMPLIED WARRANTIES, INCLUDING BUT NOT LIMITED TO THE IMPLIED WARRANTIES OF MERCHANTABILITY AND FITNESS FOR A PARTICULAR PURPOSE.

The remedy of repair, replacement or refund is customer's exclusive remedy in the event of breach of this warranty.

THIS WARRANTY IS LIMITED TO NEW PRODUCTS SOLD THROUGH ENERPAC AUTHORIZED DISTRIBUTORS, ORIGINAL EQUIPMENT MANUFACTURERS OR OTHER DESIGNATED CHANNELS OF DISTRIBUTION. NO AGENT, EMPLOYEE, OR OTHER REPRESENTATIVE OF ENERPAC HAS THE AUTHORITY TO IN ANY WAY CHANGE OR AMEND THIS WARRANTY.

SELLER SHALL NOT BE SUBJECT TO AND DISCLAIMS:

(a) ANY OTHER OBLIGATIONS OR LIABILITIES ARISING OUT OF BREACH OF CONTRACT OR OF WARRANTY,

Electronic products and components are warranted against defects in material and workmanship for a period of two years from the date of purchase.

(b) ANY OBLIGATIONS WHATSOEVER ARISING FROM TORT CLAIMS (INCLUDING NEGLIGENCE AND STRICT LIABILITY) OR ARISING UNDER THEORIES OR LAW WITH RESPECT TO PRODUCTS SOLD OR SERVICES RENDERED BY SELLER OR ANY UNDERTAKINGS, ACTS OR OMISSIONS RELATING THERETO, AND

The following items supplied with ENERPAC products are excluded from this warranty:

Components not manufactured by ENERPAC, including air motors, electric motors, gasoline engines, and diesel engines. Such items are warranted to the extent of the warranty provided by the manufacturers of such items.

(c) ALL CONSEQUENTIAL, INCIDENTAL AND CONTINGENT DAMAGES WHATSOEVER.

ENERPAC's liability in all cases is limited to, and shall not exceed, the purchase price paid.

If the customer believes a product is defective, the product must be delivered, or shipped freight prepaid, to the nearest ENERPAC Authorized Service Center. The customer should contact ENERPAC to locate and Authorized Service Center in the customer's area.

For the nearest authorized ENERPAC SERVICE CENTER, please call ENERPAC at 1-800-558-0530 or visit the ENERPAC web site at www.Enerpac.com.

Products that do not conform to this warranty will be returned by ground transportation, freight prepaid.

Offer of Sale

PARKER-HANNIFIN CORPORATION OFFER OF SALE

1. **Definitions.** As used herein, the following terms have the meanings indicated.

Buyer:	means any customer receiving a Quote for Products from Seller.
Goods:	means any tangible part, system or component to be supplied by the Seller.
Products:	means the Goods, Services and/or Software as described in a Quote provided by the Seller.
Quote:	means the offer or proposal made by Seller to Buyer for the supply of Products.
Seller:	means Parker-Hannifin Corporation, including all divisions and businesses thereof.
Services:	means any services to be supplied by the Seller.
Software:	means any software related to the Products, whether embedded or separately downloaded.
Terms:	means the terms and conditions of this Offer of Sale or any newer version of the same as published by Seller electronically at www.parker.com/saleterms .

2. **Terms.** All sales of Products by Seller are contingent upon, and will be governed by, these Terms and, these Terms are incorporated into any Quote provided by Seller to any Buyer. Buyer's order for any Products whether communicated to Seller verbally, in writing, by electronic data interface or other electronic commerce, shall constitute acceptance of these Terms. Seller objects to any contrary or additional terms or conditions of Buyer. Reference in Seller's order acknowledgement to Buyer's purchase order or purchase order number shall in no way constitute an acceptance of any of Buyer's terms of purchase. No modification to these Terms will be binding on Seller unless agreed to in writing and signed by an authorized representative of Seller.

3. **Price; Payment.** The Products set forth in Seller's Quote are offered for sale at the prices indicated in Seller's Quote. Unless otherwise specifically stated in Seller's Quote, prices are valid for thirty (30) days and do not include any sales, use, or other taxes or duties. Seller reserves the right to modify prices at any time to adjust for any raw material price fluctuations. Unless otherwise specified by Seller, all prices are F.C.A. Seller's facility (INCOTERMS 2010). All sales are contingent upon credit approval and payment for all purchases is due thirty (30) days from the date of invoice (or such date as may be specified in the Quote). Unpaid invoices beyond the specified payment date incur interest at the rate of 1.5% per month or the maximum allowable rate under applicable law.

4. **Shipment; Delivery; Title and Risk of Loss.** All delivery dates are approximate. Seller is not responsible for damages resulting from any delay. Regardless of the manner of shipment, delivery occurs and title and risk of loss or damage pass to Buyer, upon placement of the Products with the shipment carrier at Seller's facility. Unless otherwise agreed, Seller may exercise its judgment in choosing the carrier and means of delivery. No deferment of shipment at Buyers' request beyond the respective indicated shipping date will be made except on terms that will indemnify, defend and hold Seller harmless against all loss and additional expense. Buyer shall be responsible for any additional shipping charges incurred by Seller due to Buyer's acts or omissions.

5. **Warranty.** The warranty related to the Products is as follows: (i) Goods are warranted against defects in material or workmanship for a period of twelve (12) months from the date of delivery or 2,000 hours of use, whichever occurs first; (ii) Services shall be performed in accordance with generally accepted practices and using the degree of care and skill that is ordinarily exercised and customary in the field to which the Services pertain and are warranted for a period of six (6) months from the completion of the Services by Seller; and (iii) Software is only warranted to perform in accordance with applicable specifications provided by Seller to Buyer for ninety (90) days from the date of delivery or, when downloaded by a Buyer or end-user, from the date of the initial download. All prices are based upon the exclusive limited warranty stated above, and upon the following disclaimer:

DISCLAIMER OF WARRANTY: THIS WARRANTY IS THE SOLE AND ENTIRE WARRANTY PERTAINING TO PRODUCTS. SELLER DISCLAIMS ALL OTHER WARRANTIES, EXPRESS AND IMPLIED, INCLUDING DESIGN, NONINFRINGEMENT, MERCHANTABILITY, AND FITNESS FOR A PARTICULAR PURPOSE. SELLER DOES NOT WARRANT THAT THE SOFTWARE IS ERROR-FREE OR FAULT-TOLERANT, OR THAT

BUYER'S USE THEREOF WILL BE SECURE OR UNINTERRUPTED. BUYER AGREES AND ACKNOWLEDGES THAT UNLESS OTHERWISE AUTHORIZED IN WRITING BY SELLER THE SOFTWARE SHALL NOT BE USED IN CONNECTION WITH HAZARDOUS OR HIGH RISK ACTIVITIES OR ENVIRONMENTS. EXCEPT AS EXPRESSLY STATED HEREIN, ALL PRODUCTS ARE PROVIDED "AS IS".

6. **Claims; Commencement of Actions.** Buyer shall promptly inspect all Products upon receipt. No claims for shortages will be allowed unless reported to the Seller within ten (10) days of delivery. Buyer shall notify Seller of any alleged breach of warranty within thirty (30) days after the date the non-conformance is or should have been discovered by Buyer. Any claim or action against Seller based upon breach of contract or any other theory, including tort, negligence, or otherwise must be commenced within twelve (12) months from the date of the alleged breach or other alleged event, without regard to the date of discovery.

7. **LIMITATION OF LIABILITY.** IN THE EVENT OF A BREACH OF WARRANTY, SELLER WILL, AT ITS OPTION, REPAIR OR REPLACE THE NON-CONFORMING PRODUCT, RE-PERFORM THE SERVICES, OR REFUND THE PURCHASE PRICE PAID WITHIN A REASONABLE PERIOD OF TIME. **IN NO EVENT IS SELLER LIABLE FOR ANY SPECIAL, INDIRECT, INCIDENTAL OR CONSEQUENTIAL DAMAGES ARISING OUT OF, OR AS THE RESULT OF, THE SALE, DELIVERY, NON- DELIVERY, SERVICING, NON-COMPLETION OF SERVICES, USE, LOSS OF USE OF, OR INABILITY TO USE THE PRODUCTS OR ANY PART THEREOF, LOSS OF DATA, IDENTITY, PRIVACY, OR CONFIDENTIALITY, OR FOR ANY CHARGES OR EXPENSES OF ANY NATURE INCURRED WITHOUT SELLER'S WRITTEN CONSENT, WHETHER BASED IN CONTRACT, TORT OR OTHER LEGAL THEORY. IN NO EVENT SHALL SELLER'S LIABILITY UNDER ANY CLAIM MADE BY BUYER EXCEED THE PURCHASE PRICE PAID FOR THE PRODUCTS.**

8. **Loss to Buyer's Property.** Any designs, tools, patterns, materials, drawings, confidential information or equipment furnished by Buyer or any other items which are or become Buyer's property, will be considered obsolete and may be destroyed by Seller after two (2) consecutive years have elapsed without Buyer ordering the Products manufactured using such property. Seller shall not be responsible for any loss or damage to such property while it is in Seller's possession or control.

9. **Special Tooling.** Special Tooling includes but is not limited to tooling, jigs, fixtures and associated manufacturing equipment acquired or necessary to manufacture Products. A tooling charge may be imposed for any Special Tooling. Such Special Tooling shall be and remain Seller's property notwithstanding payment of any charges by Buyer. In no event will Buyer acquire any interest in Special Tooling belonging to Seller that is utilized in the manufacture of the Products, even if such Special Tooling has been specially converted or adapted for such manufacture and notwithstanding any charges paid by Buyer. Unless otherwise agreed, Seller has the right to alter, discard or otherwise dispose of any Special Tooling or other property in its sole discretion at any time.

10. **Security Interest.** To secure payment of all sums due, Seller retains a security interest in all Products delivered to Buyer and, Buyer's acceptance of these Terms is deemed to be a Security Agreement under the Uniform Commercial Code. Buyer authorizes Seller as its attorney to execute and file on Buyer's behalf all documents Seller deems necessary to perfect its security interest.

11. **User Responsibility.** The Buyer through its own analysis and testing, is solely responsible for making the final selection of the Products and assuring that all performance, endurance, maintenance, safety and warning requirements of the application of the Products are met. The Buyer must analyze all aspects of the application and follow applicable industry standards, specifications, and other technical information provided with the Product. If Seller provides Product options based upon data or specifications provided by the Buyer, the Buyer is responsible for determining that such data and specifications are suitable and sufficient for all applications and reasonably foreseeable uses of the Products. In the event the Buyer is not the end-user, Buyer will ensure such end-user complies with this paragraph.

12. **Use of Products, Indemnity by Buyer.** Buyer shall comply with all instructions, guides and specifications provided by Seller with the Products. Unauthorized Uses. If Buyer uses or resells the Products for any uses prohibited in Seller's instructions, guides or specifications, or Buyer otherwise fails to comply with Seller's instructions, guides and specifications, Buyer acknowledges that any such use, resale, or non-

Continued on next page

A Hose	<p>compliance is at Buyer's sole risk. Buyer shall indemnify, defend, and hold Seller harmless from any losses, claims, liabilities, damages, lawsuits, judgments and costs (including attorney fees and defense costs), whether for personal injury, property damage, intellectual property infringement or any other claim, brought by or incurred by Buyer, Buyer's employees, or any other person, arising out of: (a) improper selection, application, design, specification or other misuse of Products provided by Seller; (b) any act or omission, negligent or otherwise, of Buyer; (c) Seller's use of patterns, tooling, equipment, plans, drawings, designs or specifications or other information or things furnished by Buyer; (d) damage to the Products from an external cause, repair or attempted repair by anyone other than Seller, failure to follow instructions, guides and specifications provided by Seller, use with goods not provided by Seller, or opening, modifying, deconstructing or tampering with the Products for any reason; or (e) Buyer's failure to comply with these Terms. Seller shall not indemnify Buyer under any circumstance except as otherwise provided in these Terms.</p>	<p>a reasonable allowance for depreciation. Seller has no obligation or liability for any claim of infringement: (i) arising from information provided by Buyer; or (ii) directed to any Products provided hereunder for which the designs are specified in whole or part by Buyer; or (iii) resulting from the modification, combination or use in a system of any Products provided hereunder. The foregoing provisions of this Section constitute Seller's sole and exclusive liability and Buyer's sole and exclusive remedy for such claims of infringement of Intellectual Property Rights.</p>
B Tubing		<p>20. Governing Law. These Terms and the sale and delivery of all Products are deemed to have taken place in, and shall be governed and construed in accordance with, the laws of the State of Ohio, as applicable to contracts executed and wholly performed therein and without regard to conflicts of laws principles. Buyer irrevocably agrees and consents to the exclusive jurisdiction and venue of the courts of Cuyahoga County, Ohio with respect to any dispute, controversy or claim arising out of or relating to the sale and delivery of the Products.</p>
C Coiled Air Hose & Fittings	<p>13. Cancellations and Changes. Buyer may not cancel or modify any order for any reason, except with Seller's written consent and upon terms that will indemnify, defend and hold Seller harmless against all direct, incidental and consequential loss or damage. Seller, at any time, may change Product features, specifications, designs and availability.</p> <p>14. Limitation on Assignment. Buyer may not assign its rights or obligations without the prior written consent of Seller.</p> <p>15. Force Majeure. Seller does not assume the risk and is not liable for delay or failure to perform any of Seller's obligations by reason of events or circumstances beyond its reasonable control ("Events of Force Majeure"). Events of Force Majeure shall include without limitation: accidents, strikes or labor disputes, acts of any government or government agency, acts of nature, delays or failures in delivery from carriers or suppliers, shortages of materials, or any other cause beyond Seller's reasonable control.</p>	<p>21. Entire Agreement. These Terms, along with the terms set forth in the main body of any Quote, forms the entire agreement between the Buyer and Seller and constitutes the final, complete and exclusive expression of the terms of sale. In the event of a conflict between any term set forth in the main body of a Quote and these Terms, the terms set forth in the main body of the Quote shall prevail. All prior or contemporaneous written or oral agreements or negotiations with respect to the subject matter shall have no effect. These Terms may not be modified unless in writing and signed by an authorized representative of Seller.</p>
D Transportation	<p>16. Waiver and Severability. Failure to enforce any provision of these Terms will not invalidate that provision; nor will any such failure prejudice Seller's right to enforce that provision in the future. Invalidation of any provision of these Terms by legislation or other rule of law shall not invalidate any other provision herein and, the remaining provisions will remain in full force and effect.</p> <p>17. Termination. Seller may terminate any agreement governed by or arising from these Terms for any reason and at any time by giving Buyer thirty (30) days prior written notice. Seller may immediately terminate, in writing, if Buyer: (a) breaches any provision of these Terms (b) appoints a trustee, receiver or custodian for all or any part of Buyer's property (c) files a petition for relief in bankruptcy on its own behalf, or one if filed by a third party (d) makes an assignment for the benefit of creditors; or (e) dissolves its business or liquidates all or a majority of its assets.</p>	<p>22. Compliance with Laws. Buyer agrees to comply with all applicable laws, regulations, and industry and professional standards, including those of the United States of America, and the country or countries in which Buyer may operate, including without limitation the U.S. Foreign Corrupt Practices Act ("FCPA"), the U.S. Anti-Kickback Act ("Anti-Kickback Act"), U.S. and E.U. export control and sanctions laws ("Export Laws"), the U.S. Food Drug and Cosmetic Act ("FDCA"), and the rules and regulations promulgated by the U.S. Food and Drug Administration ("FDA"), each as currently amended. Buyer agrees to indemnify, defend, and hold harmless Seller from the consequences of any violation of such laws, regulations and standards by Buyer, its employees or agents. Buyer acknowledges that it is familiar with all applicable provisions of the FCPA, the Anti-Kickback Act, Export Laws, the FDCA and the FDA and certifies that Buyer will adhere to the requirements thereof and not take any action that would make Seller violate such requirements. Buyer represents and agrees that Buyer will not make any payment or give anything of value, directly or indirectly, to any governmental official, foreign political party or official thereof, candidate for foreign political office, or commercial entity or person, for any improper purpose, including the purpose of influencing such person to purchase Products or otherwise benefit the business of Seller. Buyer further represents and agrees that it will not receive, use, service, transfer or ship any Product from Seller in a manner or for a purpose that violates Export Laws or would cause Seller to be in violation of Export Laws.</p>
E Fittings	<p>18. Ownership of Software. Seller retains ownership of all Software supplied to Buyer hereunder. In no event shall Buyer obtain any greater right in and to the Software than a right in the nature of a license limited to the use thereof and subject to compliance with any other terms provided with the Software.</p>	<p>5/2017</p>
F Tooling, Equipment & Accessories	<p>19. Indemnity for Infringement of Intellectual Property Rights. Seller is not liable for infringement of any patents, trademarks, copyrights, trade dress, trade secrets or similar rights ("Intellectual Property Rights") except as provided in this Section. Seller will defend at its expense and will pay the cost of any settlement or damages awarded in an action brought against Buyer based on a third party claim that one or more of the Products sold hereunder infringes the Intellectual Property Rights of a third party in the country of delivery of the Products by the Seller to the Buyer. Seller's obligation to defend and indemnify Buyer is contingent on Buyer notifying Seller within ten (10) days after Buyer becomes aware of any such claim, and Seller having sole control over the defense of the claim including all negotiations for settlement or compromise. If one or more Products sold hereunder is subject to such a claim, Seller may, at its sole expense and option, procure for Buyer the right to continue using the Products, replace or modify the Products so as to render them non-infringing, or offer to accept return of the Products and refund the purchase price less</p>	
G General Technical		

Part Number Index

Part Number	Page	Part Number	Page	Part Number	Page	Part Number	Page
015301	F-5, F-8, F13	10654	E-11	14156	E-19	1J056	E-20
015302	F-8, F-9	10656	E-16	14191N	E-38	1J0CG	E-60
015303	F-8, F-9	10691N	E-35	14956	E-19	1J156	E-20
015304	F-8, F-9	10691NRD	E-36			1J191N	E-40
015305	F-8, F-9	10693N	E-45	16191N	E-38		
015306	F-6, F-8	10694	E-47	16791N	E-38	1J256	E-21
015307	F-6	10695	E-47	16792	E-43	1J556	E-21
015308	F-6						
015309	F-6	106CG	E-58	16991N	E-38	1J754	E-10
015310	F-8, F-9	106CY	E-63	16992	E-43	1J756	E-22
015411	F-8, F-9	106SF	E-67	17791N	E-39	1J791N	E-40
015412	F-8, F-9			17991N	E-39	1J793N	E-46
015413	F-8, F-9	10756	E-16			1J7CG	E-60
015414	F-8, F-9	10791N	E-36	19256	E-23		
015415	F-8, F-9	107CG	E-58	19291N	E-42	1J954	E-11
015736	F-6	10856	E-17			1J956	E-22
		10891N	E-36	1AL56	E-24	1J991N	E-41
025349	F-6, F-9	108MS	E-65	1AL91N	E-39	1J993N	E-46
025399	F-5, F-9, F13			1ALCG	E-59	1J9CG	E-60
		10C56	E-23			1J9CY	E-64
090	E-33	1120	D-4	1B156	E-24		
		11356	E-17	1B256	E-24	1JBSF	E-67
101-(PTFE)	B-50	113CY	E-63	1B291N	E-42	1JC54	E-10
10156	E-14	11C56	E-23	1B456	E-24	1JC56	E-20
10191N	E-35			1C356	E-25	1JC91N	E-41
10193N	E-44	12891N	E-36	1C456	E-25	1JC93N	E-46
101CG	E-56	12892	E-43	1C556	E-25	1JCCG	E-61
101CY	E-62	13491N	E-37	1C656	E-26	1JCCY	E-63
101SF	E-67	134MS	E-65	1C956	E-26		
101SQ	E-68			1CA56	E-26	1JS56	E-21
		13754	E-11	1CE56	E-27	1JSCG	E-61
10256	E-14	13756	E-18	1CF56	E-27	1JSSF	E-67
102CG	E-57	13791N	E-37				
102CY	E-62	13793N	E-45	1D056	E-28	1L956	E-19
		137CG	E-59	1D286	E-28	1L9CG	E-61
103-(FEP)	B-76			1D956	E-28		
10356	E-15	13954	E-11			1LMCY	E-64
1035HT	A-47	13956	E-18	1FN91N	E-40		
10391N	E-35	13991N	E-37	1FUCG	E-60	1P691N	E-39
103CG	E-57	13993N	E-45			1PDCY	E-64
		139CG	E-59	1GKCY	E-64		
104-(PFA)	B-90	139CY	E-63	1GK91N	E-42	1TFMS	E-65
10456	E-15	13E56	E-17			1TU56	E-22
				1HUSQ	E-68	1TU91N	E-41
105-(H.P. PFA)	B-92					1TUCG	E-61
10556	E-15						
105CG	E-57						

A Hose

B Tubing

C Coiled Air Hose & Fittings

D Transportation

E Fittings

F Tooling, Equipment & Accessories

G General Technical

Part Number Index (cont.)

Part Number	Page	Part Number	Page	Part Number	Page	Part Number	Page
1WU54	E-12	2GK-Nut	E-42, E-64	6-2 CTX-S	F-9	822011	F-8, F-9
1WW54	E-12	2TFMS	E-66	6-6 CTX-S	F-8, F-9	822012	F-8, F-9
1WY54	E-12					822031	F-8, F-9
20090	E-33	332T-115V-PFD	F-17	60 HAB	E-33	82C-061L-PFD	F-10
201-(Metric PTFE)	B-50	3PSG	E-64	61 HAB	E-33	82C-OAP-PFD	F-13
20151	E-8	510A	A-32	68NTA	D-10	82C-OEP-PFD	F-14
20190	E-29	510C	A-33	685RA	E-12	82C-OHP-PFD	F-14
201BU	E-55	515H	A-36	703	B-88	82C-CHD-PFD	F-10
203-(Metric FEP)	B-77	518C	A-34	704	B-88	82C-KKB-PFD	F-10
20351	E-8	518D	A-35	705	B-88	82C-R01-PFD	F-5, F-8, F-10, F-15
204-(Metric PFA)	B-91	520N	A-37	731512-Blue, Red	D-8	82C-R02-PFD	F-10
205-(Metric H.P. PFA)	B-93	527BA	A-38	731513-Blue, Red	D-8	83C-080-PFD	F-12
20651	E-9	528N	A-37	731516	D-8	83C-081-PFD	F-12
20690	E-30	53DM	A-39	731522	D-8	83C-0CB-PFD	F-12
206BU	E-55	538DM	A-39	731611-Blue, Red	D-8	83C-0DR-PFD	F-15
20851	E-9	540N	A-40	731612-Blue, Red	D-8	83C-R02-PFD	F-12
20890	E-30	540P	A-41	741526	D-8	83C-R02H-PFD	F-12
208MS	E-66	55LT	A-42	741590-Blue, Red	D-8	83C-S40-PFD	F-12
213BU	E-55	55AG	F-19	751597	D-8	83C-S20-PFD	F-12
22890	E-30	55SG	F-19	751641	D-8	83FR	A-46
23490	E-31	55SSG	F-19	751655	D-8	85C-00L-PFD	F-10, F-11
23790	E-31	5PSG	F-19	751656-Blk	D-8	85C-061L-PFD	F-11
23951	E-9	56DH	A-43	751657	D-9	85C-0HP-PFD	F-14
23990	E-31	560TJ	A-28	751659	D-9	85C-OEP-PFD	F-14
24398-PFD	F-17	563TJ	A-29	771164	D-8	85C-1PH-PFD	F-10, F-11
2613	F-20	575X	A-44	80C-0DR-PFD	F-15	85C-CHD-PFD	F-11
2625	F-20	575XN	A-44	80C-SDR	F-15	85C-KKB-PFD	F-11
26190	E-31	580661-PFD	F-17	811537	D-10	85C-R01-PFD	F-11, F-15
26790	E-32	580N	A-45	81914/1	B-74	85C-R02-PFD	F-11
26990	E-32	588N	A-45	81914/2	B-74	85C-STD-PFD	F-10, F-11
2740	F-20	590TJ	A-30	81914/3	B-84	881540-PFD	F-17
27790	E-32	594TJ	A-31	81914/4	B84	8PC-030-PFD	F-16
2799	F-20	5CNG	A-49	81C-R01-PFD	F-16	8PC-00P-PFD	F-16
27990	E-32	5CNG/5CNGLT	F-18	81C-R02-PFD	F-16	8WC-00P-PFD	F-16
						919/919B	A-58
						919J	A-59
						919U	A-60
						929/929B	A-61
						929BJ	A-62

Part Number Index (cont.)

Part Number	Page	Part Number	Page	Part Number	Page	Part Number	Page
939/939B	A-63	H580N	A-45	PAT	B-24	TH11-1-PFD	F-17
		H6	A-25			TH9-1-XXX	F-14
94C-080-PFD	F-5	HBR	F-18	PEFR	B-16		
94C-001-PFD	F-5	HDPE	B-18	PF ANSI Flange	E-53	TSWTF	B-60
94C-002-PFD	F-5	HFSR	A-23	PF150	E-53	TUBE	E-53
94C-MKS	F-7	HFS2R	A-24	PF154	E-53	U	B-30
944B	A-64	HLB	A-51	PF156	E-53	UM	B-32
				PFT	D-5		
95FR	B-38	HS1.25FEP	B-82			VBL	F-14
955B	A-65	HS1.3FEP	B-78	PLCF	E-53	VBS	F-14
		HS1.6FEP	B-80	PP	B-28		
9A	A-70	HS2TFI	B-62	PPB	B-28		
9M	A-70	HS2TFL, AWG	B-64	PSG	F-21		
9P	A-70	HS2TFL, Fractional	B-62	PTC	F-17		
A0	C-6	HS2TFS, AWG	B-64	PTC-001-RB	F-17		
AS-Y	F-20	HS2TFS, Fractional	B-62	PTH	A-54		
AHUF5	C-10	HS2TFT, AWG	B-64	PV (guard)	F-18		
AUFS	C-8	HS2TFT, Fractional	B-62	PV (tubing)	B-40		
B9	A-48	HS4TFI	B-68	R6	A-26		
CL	E-50	HTB	A-27	S5N	A-55		
CNGG	F-18	HTC	F-17	S6	A-56		
CNGRP	A-50	HTFL	D-6	S9	A-57		
CR	B-86	HU	B-34	SAN	E-54		
CV	B-70; B-84	HUM	B-36	SC300	E-49		
CVL	B-72	MBS	E-50	SCB	A-67		
CVH	B-72	MC	C-7	SCBV	A-68		
CY02-652317	E-64	MCB	C-11	SCW	A-67		
D6R	A-22	MIL	E-51	SCWV	A-68		
D6RX	A-22	ML	C-7	SFR	E-54		
E	B-14	MLB	C-11	SQ-101-SW	F-13		
E Male Cam & Groove	E-50	MP	E-52	SQ Mender	F-13		
EB	B-14	MSAN	E-54	ST300	E-49		
		MSH	A-52	STB	A-66		
		MSXL	A-53	STW	A-66		
FBS	E-50	N	B-20	TFH, AWG	B-56		
FIL	E-51	NA-6520	E-64	TFL, AWG	B-56		
FJX	E-52	NB	B-20	TFL, Fractional	B-54		
FORFS	E-52	NBR	B-26	TFS, AWG	B-56		
FP	E-51	NCB	A-69	TFS, Fractional	B-54		
FS	F-20	NCW	A-69	TFT, AWG	B-56		
		NN	B-20	TFT, Fractional	B-54		
GH9211	D-8	NNR	B-26				
GH9212	D-8	NR	B-26				

A Hose

B Tubing

C Coiled Air Hose & Fittings

D Transportation

E Fittings

F Tooling, Equipment & Accessories

G General Technical

Key Word Index

Part	Page	Part	Page	Part	Page
1.25/1 Heat Shrink	B-82	Cut-off Tools	F-17	Hose Guard	F-18
1.3/1 Heat Shrink	B-78	CY Series	E-62	Hybrid® Hose.....	A-22, A-23, A-24, A-27
1.67/1 Heat Shrink	B-80	Diagnostic Hose	A-43	Hydraulic Press Kit	F-16
2:1 Heat Shrink	B-64	Die Racks	F-15	Insertion Block.....	F-14
4:1 Heat Shrink	B-68	Dies	F-15	Karrykrimp.....	F-10
51 Series	E-8	Diesel Fuel Tubing	D-5	Karrykrimp 2.....	F-11
54 Series	E-10	DuraGard™ (83FR).....	A-46	Low Temperature Hose (55LT).....	A-42
56 Series	E-13	Duramax™ (53DM).....	A-39	Lubrication Line Hose (HLB)	A-51
90 Series	E-29	Elec. Conductive Compressed Nat. Gas Hose.....	A-49; A-50	Marine Hose (MSH).....	A-52
91N Series.....	E-34	Eliminator® (HTB)	A-27	Metal Hose	A-70
92 Series	E-43	Fast Response Hose (575x).....	A-44	MiniKrimp	F-5
93N Series.....	E-44	Fast-Stor® Air Hose	C-6	Mounts	F-6
94 Series	E-47	Fast-Stor® Fittings.....	C-7; C-11	MS Series	E-65
95 Series	E-47	FEP Heat Shrink	B-78	Multitube® Bundles.....	A-71
A-LOK® Fitting.....	E-39, E-53, E-59	FEP Tubing	B-76	NoMar® Fast-Stor® Assy.....	C-8
Abrasion King® (R6)	A-26	Field Attachable Fitting	E-2	NoMar® Fast-Stor® Coil Assy	C-10
Adapter.....	E-12	Fifth Wheel Slider	D-10	NoMar® Fast-Stor® Fittings.....	C-11
Air Brake Tubing	D-4	Fire Sleeve	F-20	Non-Conductive Hose (518D)	A-35
Air Hose.....	C-4	Flange	E-40, E-53, E-54	Nylon Air Brake Tubing.....	D-4
Anti-Kink Casing	F-20	Flange Retainer	E-54	Nylon Tubing	B-20
Armor Guard	F-19, F-21	Flare-Seal Hose.....	A-68	PAGE Fittings	E-48
AWG Tubing.....	B-56	Fluoropolymer Tubing.....	B-44	Parkrimp Dies.....	F-15
Bend Restrictor.....	F-18	Gates Conversion Kit	F-16	Parkrimp 2	F-12
Brakcoil.....	D-8	General Hydraulic Hose... A-33, A-37, A-40		Partek Sleeve	F-20
Breathing Air Hose	A-38	General Purpose Transfer Hose.....	A-48	PFA Tubing	B-90
BU Series	E-55	Grease Zerk Fitting	E-64	polyflex Hose.....	A-72
Bulkhead Nut	E-64	Guards.....	F-18	Polyethylene Tubing.....	B-12
Bundles	D-11	Harnesses	D-11	Polypropylene Tubing.....	B-28
CG Series	E-56	Heat Shrink Tubing	B-62; B-78	Polyurethane Tubing	B-30
Clear Vinyl Hose Guard.....	F-18	Heavy Wall PTFE Hose.....	A-61	Predator® (S5, S6, S9).....	A-55
Clear Vinyl Tubing	B-40	High Density Tubing	B-18	PTFE Heat Shrink	B-62
Collars.....	E-49	High Purity Tubing	B-92	PTFE Hose.....	A-58
Conversion Kits	F-16	High Temperature Power Cleaning Hose.....	A-47	PTFE Tubing	B-50
Convolute Hose	A-63 : A-69	Hose Cutter	F-17	Pumps (Crimpers)	F-13
Convolute Tubing	B-70; B-84			Pure Air Tubing	B-24
Corrugated Tubing	B-86				
Crimp Fittings	E-2				
Crimpers/Crimping Machines.....	F-5, F-10				

Key Word Index (cont.)

Part	Page	Part	Page	Part	Page
Rapid Assy Fitting	E-12	TECHNICAL DATA			
Refrigerant Hose	A-32	AIR HOSE		OTHER	
Replacement Parts (MiniKrimp).....	F-8	Air Hose Size Selection	C-5	Government/Agency Specifications....	G-55
Retractable Coiled Tubing	B-88			Materials to Parflex Part Number.	G-45
Roll Cover.....	B-82	FITTINGS		Metric Conversion Chart	G-54
SCR Hose	D-12	Fitting Configurations			
Sewer Hose	A-56	by Connection & End Code.....	E-4	TOOLING	
SF Series.....	E-67	Fitting Nomenclature.....	E-3	Swage Die Selection & Specification,	
Silicone Covered PTFE Hose.....	A-59; A-62	Media to Fitting & Seal		(Sewer Hose).....	G-36
Sleeve.....	F-20	Compatibility	G-40	Vise Blocks.....	F-14
SliderCoil	D-10	Metals Corrosion Scale.....	G-45	Vise Mount	F-6
		O-Ring Material Selection Guide	G-44	Weatherhead Conversion Kit	F-16
Spaghetti Tubing	B-56	PAGE Series Sanitary Sizing			
Specialty Water Hose.....	A-41	Typical Dimensions	E-6	TUBING	
Spiral Cut Cable Wrap	B-60	HOSE		Compatiblity Chart for Fittings.....	B-8
Spring, External & Internal	F-20	Die Selection /Crimp/Swage.....	G-36	Fluoropolymer	
Spring Guard.....	F-19	Hose Assembly & Crimping	G-14	Quick Reference.....	B-46
SQ Series.....	E-68	Hose Assembly Part Number	14	Chemical Resistance.....	B-46
Swager	F-13	Hose Construction/Specifications		Property Comparison.....	B-47
		psi	A-10; A-12	Nomenclature	B-48
Table Mount.....	F-6	MPa.....	A-14; A-16	Media to Plastic Tubing	
TOUGHJACKET™ Hose	A-28; A-31	Hose Diameter Selection.....	G-5	Material Compatibility Guide	G-51
Tube Cutter	F-17	Hose Fitting Insertion Values	G-37	Metal Tube & Fitting	
Ultra Pure Tubing.....	B-24	Hose Fitting Thread Guide.....	G-38	Material Compatibility Guide	G-42
Vinyl Tubing.....	B-40	Hose Fitting Nomenclature		Pressure Ranges.....	B-11
		Thermoplastic Hose.....	A-18		
		Parflex PTFE Hose	A-20		
		Parflex PAGE Hose.....	A-21		
		Hose Permeation Data	G-8		
		Hose Selection, Inst. & Mtn.	G-11		
		Hose, Volumetric Expansion	G-6		
		Media to Hose Material			
		Compatibility.....	G-46		
		Stamped Form	13		
		Swage Instructions			
		(Sewer Hose).....	G-31		
		Thermoplastic Hose.....	A-22		
		True-Bore Hose	A-66		
		Twin/Multi-Line Separation	G-34		
		Understanding Parflex Hoses.....	A-7		

A Hose

B Tubing

C Coiled Air Hose & Fittings

D Transportation

E Fittings

F Tooling, Equipment & Accessories

G General Technical

A Hose

B Tubing

C Coiled Air Hose & Fittings

D Transportation

F Fittings

T Tooling, Equipment & Accessories

G General Technical

Notes

Parker Fluid Connectors Group

North American Divisions & Distribution Service Centers

Your complete source for quality tube fittings, hose & hose fittings, brass & composite fittings, quick-disconnect couplings, valves and assembly tools, locally available from a worldwide network of authorized distributors.

Fittings:

Available in inch and metric sizes covering SAE, BSP, DIN, GAZ, JIS and ISO thread configurations, manufactured from steel, stainless steel, brass, aluminum, nylon and thermoplastic.

Hose, Tubing and Bundles:

Available in a wide variety of sizes and materials including rubber, wire-reinforced, thermoplastic, hybrid and custom compounds.

Worldwide Availability:

Parker operates Fluid Connectors manufacturing locations and sales offices throughout North America, South America, Europe and Asia-Pacific.

For information, call toll free...

1-800-C-PARKER
(1-800-272-7537)

North American Divisions

Fluid System Connectors Division

Otsego, MI
phone 269 694 9411
fax 269 694 4614

Hose Products Division

Wickliffe, OH
phone 440 943 5700
fax 440 943 3129

Parflex Division

Ravenna, OH
phone 330 296 2871
fax 330 296 8433

Quick Coupling Division

Minneapolis, MN
phone 763 544 7781
fax 763 544 3418

Tube Fittings Division

Columbus, OH
phone 614 279 7070
fax 614 279 7685

Distribution Service Centers

Buena Park, CA

phone 714 522 8840
fax 714 994 1183

Conyers, GA

phone 770 929 0330
fax 770 929 0230

Louisville, KY

phone 502 937 1322
fax 502 937 4180

Portland, OR

phone 503 283 1020
fax 503 283 2201

Toledo, OH

phone 419 878 7000
fax 419 878 7001
fax 419 878 7420
(FCG Kit Operations)

Canada

Milton, ONT

phone 905-693-3000
fax 905-876-1958
(Contact Milton for other Service Center locations.)

Mexico

Toluca, MEX

phone (52) 722 2754 200
fax (52) 722 2722 168

